

CORTEX[®]

50mm Weightlifting Platform Frame with Band Pegs

USER MANUAL

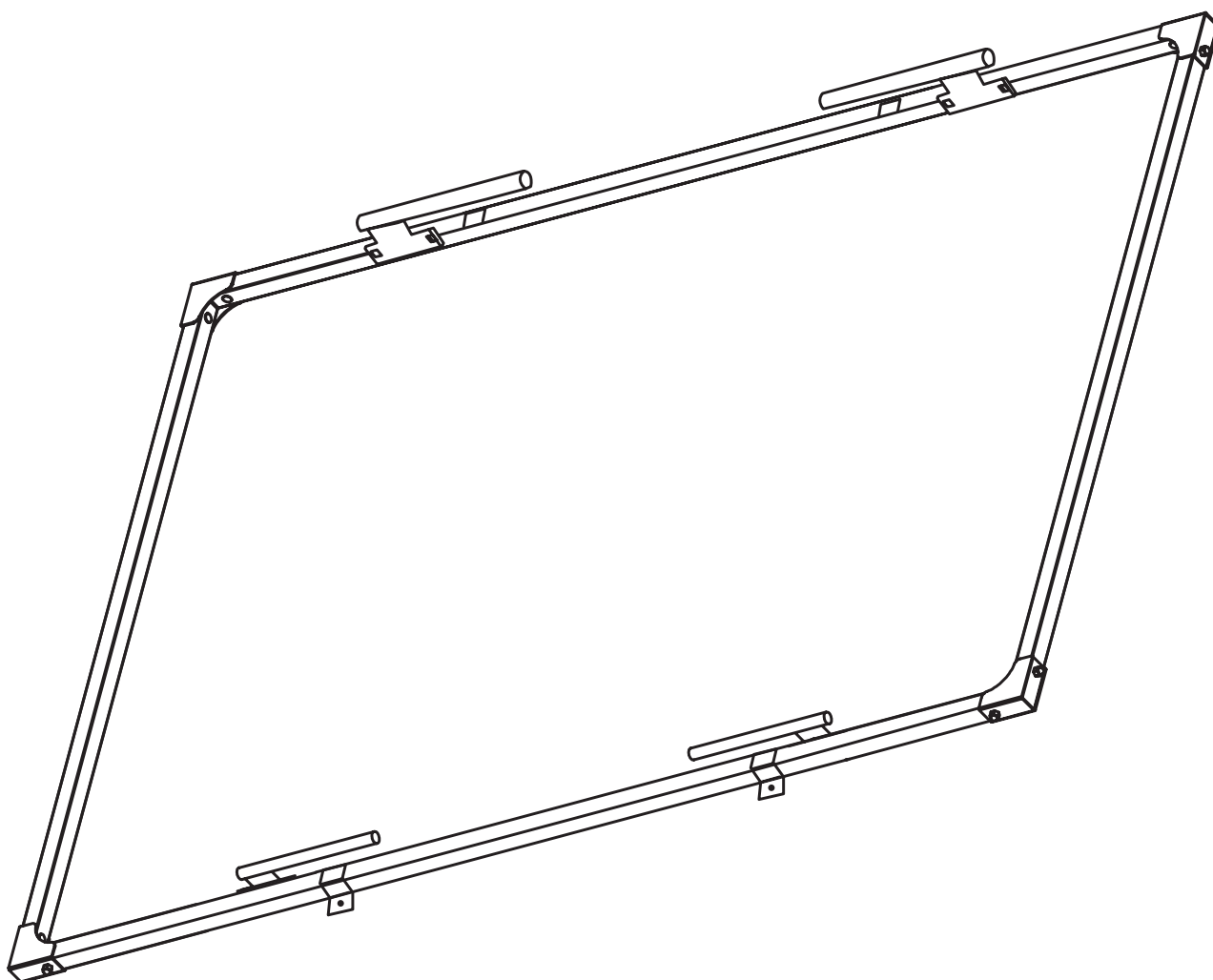

Product may vary slightly from the item pictured due to model upgrades.



**Read all instructions carefully before using this product.
Retain this owner's manual for future reference.**

NOTE:

This manual should not be used to guide your purchasing decision. Your product, and the contents inside its carton, may vary from what is listed in this manual. This manual may also be subject to updates or changes. Updated manuals are available through our website at www.lifespanfitness.com.au



TABLE OF CONTENTS

I. Important Safety Instructions	04
II. Parts List	05
III. Assembly Instructions	06
IV. Exercise Guide	07
V. Warranty	09









I. IMPORTANT SAFETY INSTRUCTIONS

 **WARNING: Read all instructions before using this machine.**

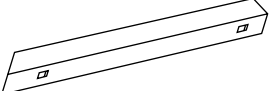
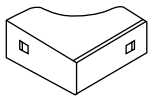
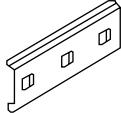
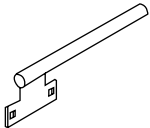
Please keep this manual with you at all times.

- It is important to read this entire manual before assembling and using the equipment. Safe and effective use can only be achieved if the equipment is assembled, maintained and used properly. **PLEASE NOTE:** It is your responsibility to ensure that all users of the equipment are informed of all warnings and precautions.
- Before starting any exercise program you should consult your doctor to determine if you have any medical or physical conditions that could put your health and safety at risk, or prevent you from using the equipment properly. Your doctor's advice is essential if you are taking medication that affects your heart rate, blood pressure or cholesterol level.
- Be aware of your body's signals. Incorrect or excessive exercise can damage your health. Stop exercising if you experience any of the following symptoms: pain, tightness in your chest, irregular heartbeat, and extreme shortness of breath, lightheadedness, dizziness or feelings of nausea. If you do experience any of these symptoms, you should consult your doctor before continuing with your exercise program.
- Keep children and pets away from the equipment. This equipment is designed for adult use only.
- Use the equipment on a solid, flat level surface with a protective cover for your floor or carpet. To ensure safety, the equipment should have at least 2 meters of free space around it.
- Before using the equipment, check that the nuts and bolts are securely tightened. If you hear any unusual noises coming from the equipment during use and assembly, stop immediately. Do not use the equipment until the problem has been rectified.
- Wear suitable clothing while using the equipment. Avoid wearing loose clothing that may get caught in the equipment or that may restrict or prevent movement.
- This equipment is designed for indoor and family use only.
- Care must be taken when lifting or moving the equipment so as not to injure your back.
- Always keep this instruction manual and assembly tools at hand for reference.
- The equipment is not suitable for therapeutic use.

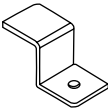
II. PARTS LIST

01	No. 1 Tube		x 2
02	No. 2 Tube		x 2
03	No. 3 Tube		x 4
04	Package Edge Box		x 4
05	Pack Edge Connection Board		x 4
06	Handle		x 4
07	Bolts		x 16
08	Nut		x 16
09	Nut Cap		x 16
10	Ground Connection Sheet		x 4
11	Self Attack Silk		x 4

III. ASSEMBLY INSTRUCTIONS

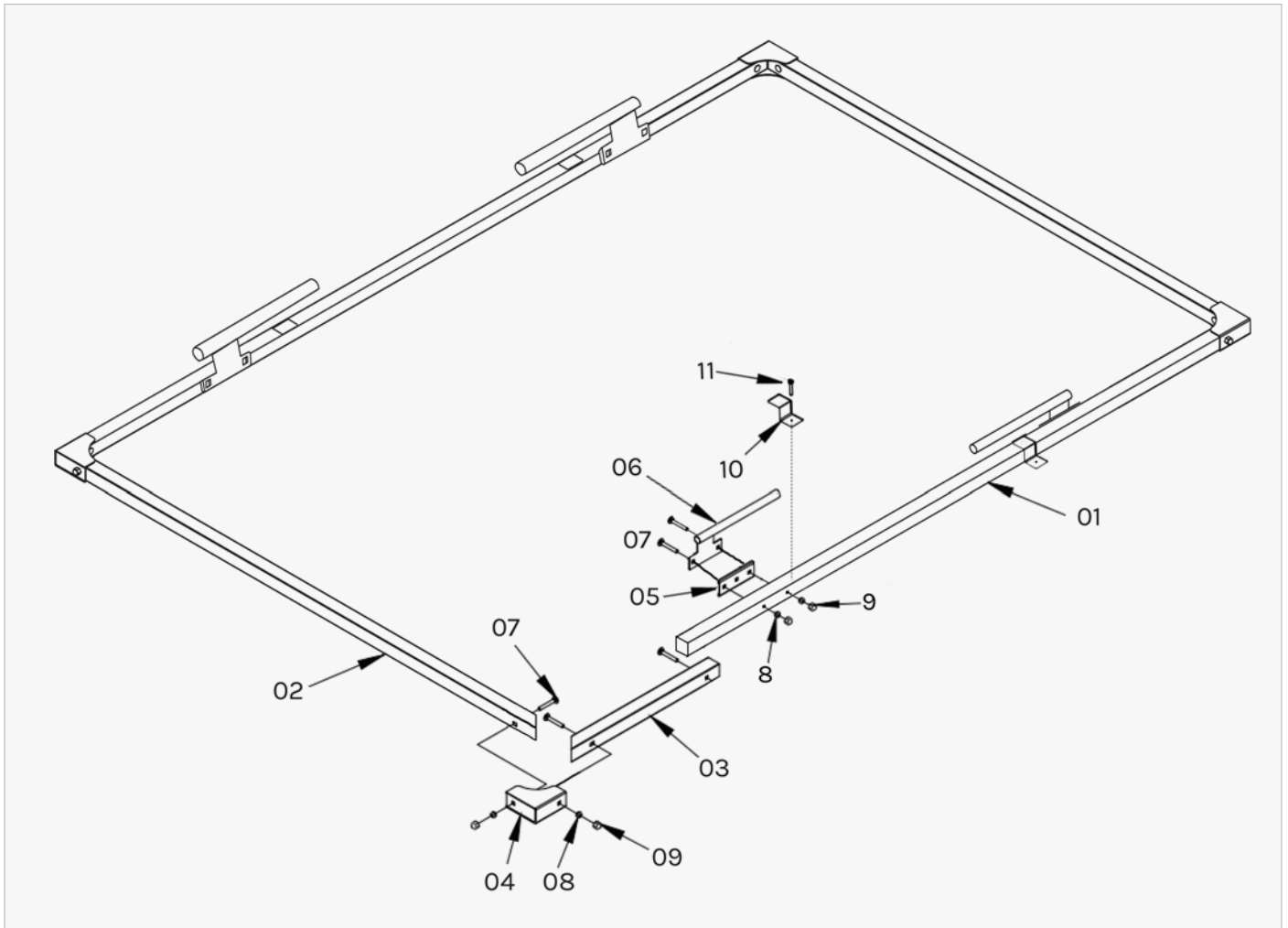

1. Join Tube Part #3 and #1 together to make the long tube, using:

- Bolts #7
- Nut #8
- Nut Cap #9
- Part #5
- Handle #6

Ensure to install Part #6 on the inside of the frame, as pictured. Tighten the nuts and bolts.

2. Once the long tubes are connected, you can join it to the corner piece #4 together with Tube #2 using:

- Bolt #7
- Nut #8
- Nut Cap #9

Do not over-tighten the bolts for the corner piece.

3. Once the frame is complete, add the lifting board and mats then secure with Part #10 and #11 as shown into the ground.

IV. EXERCISE GUIDE

ⓘ PLEASE NOTE:

Before beginning any exercise program, consult your physician. This is important especially if you are over the age of 45 or individuals with pre-existing health problems.

The pulse sensors are not medical devices. Various factors, including the user's movement, may affect the accuracy of heart rate readings. The pulse sensors are intended only as an exercise aid in determining heart rate trends in general.

Exercising is a great way to control your weight, improving your fitness and reduce the effect of aging and stress. The key to success is to make exercise a regular and enjoyable part of your everyday life.

The condition of your heart and lungs and how efficient they are in delivering oxygen via your blood to your muscles is an important factor to your fitness. Your muscles use this oxygen to provide enough energy for daily activity. This is called aerobic activity. When you are fit, your heart will not have to work so hard. It will pump a lot fewer times per minute, reducing the wear and tear of your heart.

So as you can see, the fitter you are, the healthier and greater you will feel.

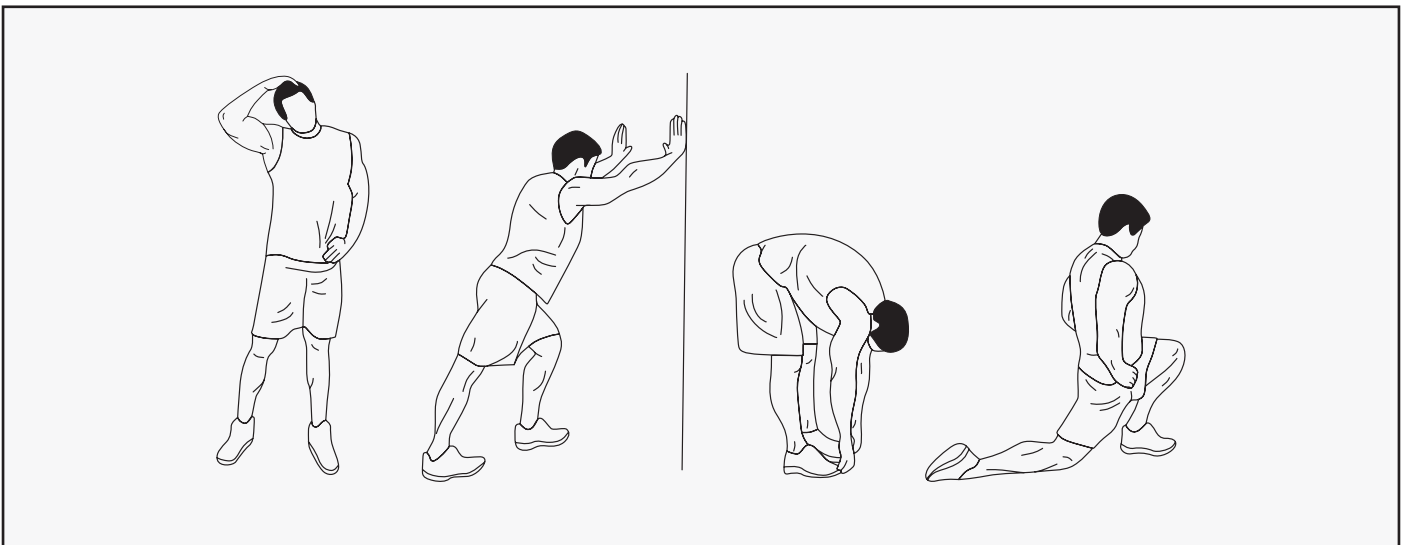

WARM UP

Start each workout with 5 to 10 minutes of stretching and some light exercises. A proper warm-up increases your body temperature, heart rate and circulation in preparation for exercise. Ease into your exercise.

After warming up, increase the intensity to your desired exercise program. Be sure to maintain your intensity for maximum performance. Breathe regularly and deeply as you exercise.

COOL DOWN

Finish each workout with a light jog or walk for at least 1 minute. Then complete 5 to 10 minutes of stretching to cool down. This will increase the flexibility of your muscles and will help prevent post-exercise problems.

WORKOUT GUIDELINES

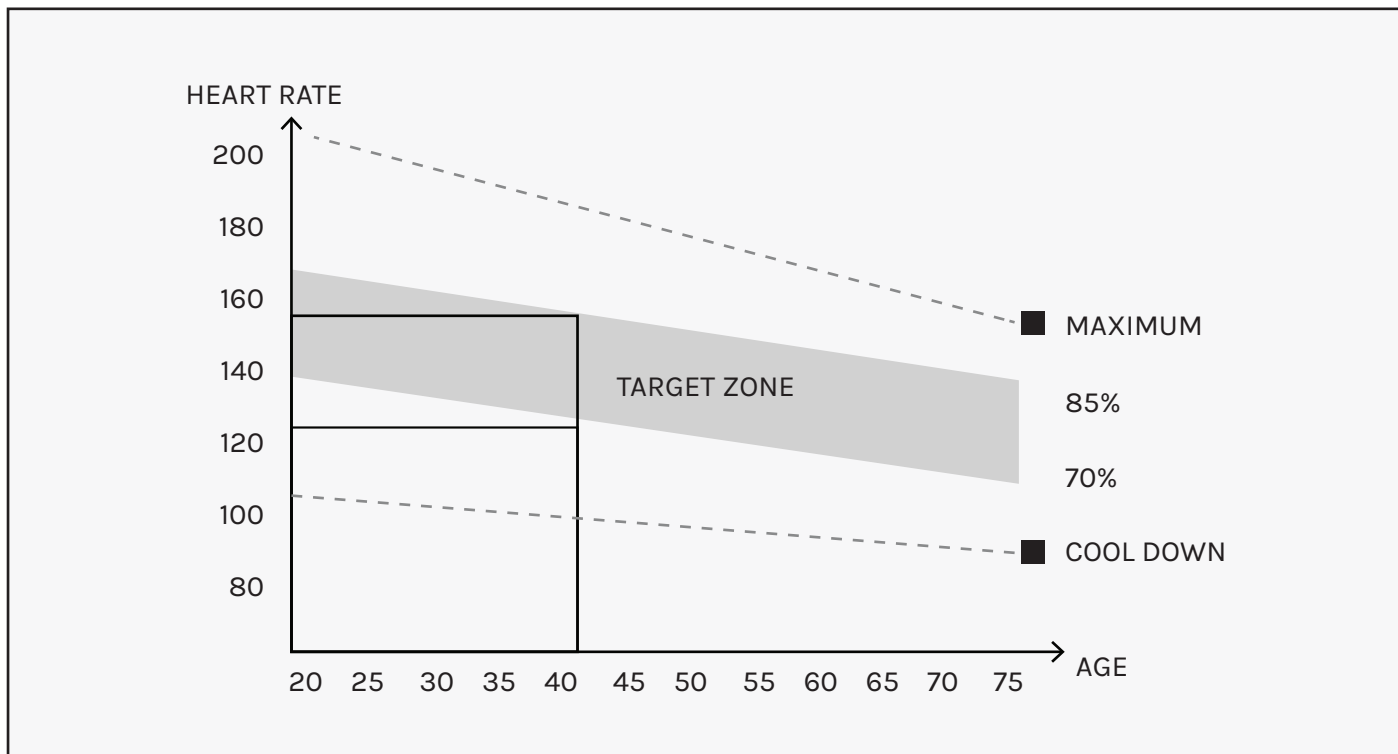

⚠ This is how your pulse should behave during general fitness exercise. Remember to warm up and cool down for a few minutes.

The most important factor here is the amount of effort you put in. The harder and longer you work, the more calories you will burn.

V. WARRANTY

AUSTRALIAN CONSUMER LAW

Many of our products come with a guarantee or warranty from the manufacturer. In addition, they come with guarantees that cannot be excluded under the Australian Consumer Law. You are entitled to a replacement or refund for a major failure and compensation for any other reasonably foreseeable loss or damage.

You are entitled to have the goods repaired or replaced if the goods fail to be of acceptable quality and the failure does not amount to a major failure. Full details of your consumer rights may be found at www.consumerlaw.gov.au.

Please visit our website to view our full warranty terms and conditions:
<http://www.lifespanfitness.com.au/warranty-repairs>

WARRANTY AND SUPPORT

Any claim against this warranty must be made through your original place of purchase. Proof of purchase is required before a warranty claim may be processed.

If you have purchased this product from the Official Lifespan Fitness website, please visit <https://lifespanfitness.com.au/warranty-form>

For support outside of warranty, if you wish to purchase replacement parts or request a repair or service, please visit <https://lifespanfitness.com.au/warranty-form> and fill in our Repair/Service Request Form or Parts Purchase Form.

Scan this QR code with your device to go to lifespanfitness.com.au/warranty-form



CORTEX[®]

WWW.LIFESPANFITNESS.COM.AU