



EXC-10H Commercial Exercise Air Bike

USER MANUAL



Read all instructions carefully before using this product. Retain this owner's manual for future reference.

IMPORTANT

All nuts and bolts are to be checked and tightened on a regular basis. This includes pedals and other moving parts. Failure to do so may cause damage to your threads and void your warranty.

NOTE:

Product may vary slightly from the item pictured due to model upgrades. This manual may be subject to updates or changes. Up to date manuals are available through our website at www.lifespanfitness.com.au



TABLE OF CONTENTS

I.	Important Safety Instructions	03
II.	Care Instructions	04
III.	Exploded Diagram	05
IV.	Parts List	06
V.	Assembly Instructions	09
VI.	Computer Operation	21
VII.	Exercise Guide	22
VIII.	Warranty	23

I. IMPORTANT SAFETY INSTRUCTIONS

WARNING: Read all instructions before using this machine.

It is important your machine receives regular maintenance to prolong its useful life. Failing to regularly maintain your machine may void your warranty.

Please keep this manual with you at all times.

- It is important to read this entire manual before assembling and using the equipment. Safe and effective use can only be achieved if the equipment is assembled, maintained and used properly. **PLEASE NOTE:** It is your responsibility to ensure that all users of the equipment are informed of all warnings and precautions
- Before starting any exercise program you should consult your doctor to determine if you have any medical or physical conditions that could put your health and safety at risk, or prevent you from using the equipment properly. Your doctor's advice is essential if you are taking medication that affects your heart rate, blood pressure or cholesterol level.
- Be aware of your body's signals. Incorrect or excessive exercise can damage your health. Stop exercising if you experience any of the following symptoms: pain, tightness in your chest, irregular heartbeat, and extreme shortness of breath, lightheadedness, dizziness or feelings of nausea. If you do experience any of these symptoms, you should consult your doctor before continuing with your exercise program.
- Keep children and pets away from the equipment. This equipment is designed for adult use only.
- Use the equipment on a solid, flat level surface with a protective cover for your floor or carpet. To ensure safety, the equipment should have at least 2 meters of free space around it.
- Before using the equipment, check that the nuts and bolts are securely tightened. If you hear any unusual noises coming from the equipment during use and assembly, stop immediately. Do not use the equipment until the problem has been rectified.
- Wear suitable clothing while using the equipment. Avoid wearing loose clothing that may get caught in the equipment or that may restrict or prevent movement.
- This equipment is designed for indoor and family use only.
- Care must be taken when lifting or moving the equipment so as not to injure your back.

- Always keep this instruction manual and assembly tools at hand for reference.
- The equipment is not suitable for therapeutic use.
- The pulse or heart rate sensors are not medical devices. Various factors, including the user's movement, may affect the accuracy of heart rate readings. The pulse sensors are intended only as exercise aids in determining heart rate trends in general.

II. CARE INSTRUCTIONS

- All nuts and bolts are to be checked and tightened on a regular basis. This includes pedals and other moving parts. **Failure to do so may cause damage to your thread and void your warranty.**
- Lubricate moving joints with grease after periods of usage.
- Be careful not to damage plastic or metal parts of the machine with heavy or sharp objects.
- The machine can be kept clean by wiping it down using dry cloth.

BATTERY USAGE

- Batteries are to be installed or replaced by adult only.
- Do not use rechargeable batteries. Do not mix different battery types. Do not mix old and new batteries. Do not mix alkaline, standard (Carbon-Zinc), or rechargeable (Nickel-Cadmium) batteries.
- Remove batteries when product is not in use.
- Remove exhausted batteries from product and dispose of in accordance with the manufacturer's recommendation.
- Do not attempt to recharge non-rechargeable batteries.
- Batteries are to be inserted with correct polarity.
- The supply terminals are not to be short-circuited.
- Do not dispose of batteries in fire, batteries may explode or leak.

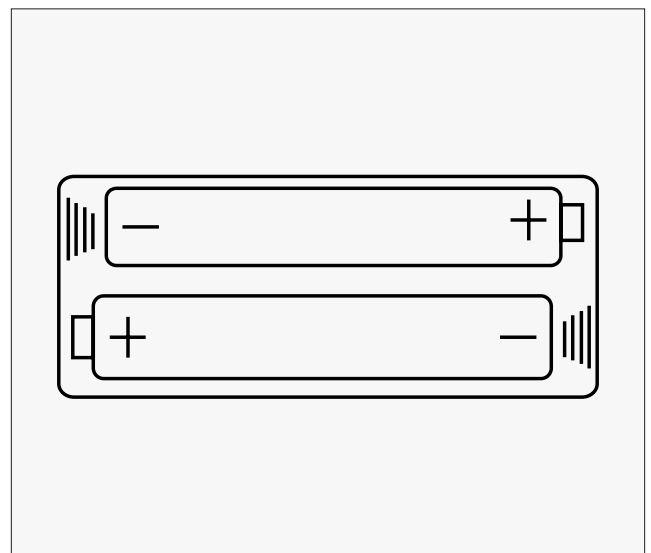

III. EXPLODED DIAGRAM

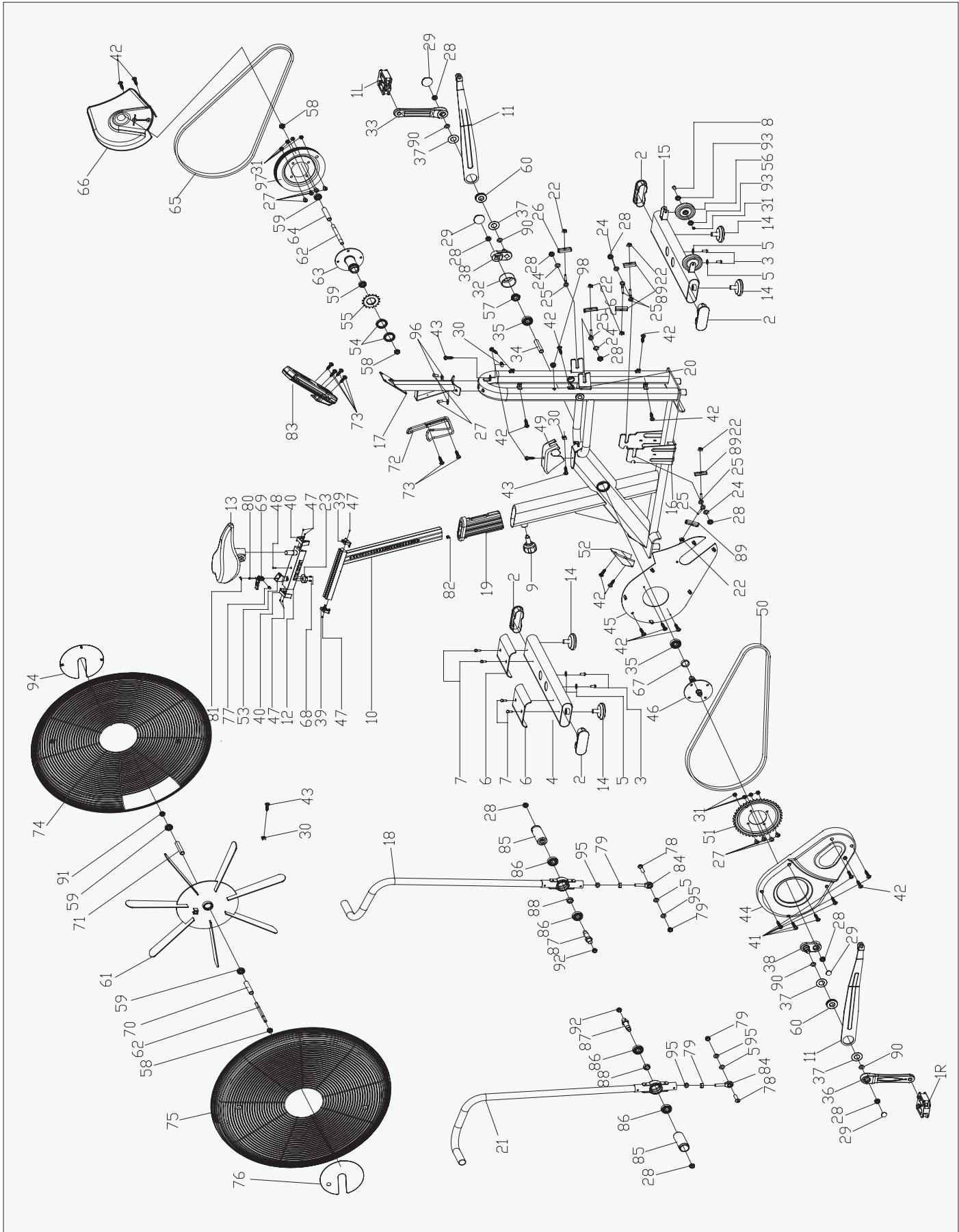

IV. PARTS LIST

! Some items on this list may come pre-installed on your equipment. If you feel like you're missing anything, please double check your equipment.

Part No.	Description	Qty	Specs
1	Pedal	1	JD-3024V (9/16")
2	End Cap 3	4	120*40*35
3	Bolt 1	4	M10*30
4	Rear Stabiliser	1	Welding
5	Flat Washer	6	10
6	Front Cover	2	160*128*3
7	Bolt 1	4	GB/845-85 ST4 8x18
8	Bolt 2	2	M8*40
9	Shape Knob	1	Φ50*91 (M16*35)
10	Vertical Seat Post	1	Welding
11	Drive Assembly	2	Welding
12	Seat Post	1	Welding
13	Seat	1	KS-9068
14	Stopper	4	Φ70*41 (M16*25)
15	Front Stabiliser	1	Welding
16	Main Frame	1	Welding
17	Electronic Watch Connecting Assembly		Welding
18	Left Handlebar Assembly	1	Welding
19	Plastic Sleeve	1	103*53.5*178
20	Sensor	1	SR-202
21	Right Handlebar Assembly	1	Welding
22	Nut	6	M6
23	Fixing Nut 2	1	Φ44.8*16.5
24	Flat Washer	4	12
25	Fixing Bolt	6	M6*85
26	Pullout Fixed Piece	2	Φ3
27	Bolt 1	10	M8*16
28	Nut	10	M12*1.25
29	Crank End Cap	4	Φ28*6.5
30	Sprocket Buckle	6	Φ1
31	Nut	10	GB/T 889.1-2000 M8
32	Plastic Ring	1	Φ56*28
33	Left Crank	1	170*15
34	Long Fixing Tube	1	Φ25* Φ20.2*41.2
35	Bearing	2	6004ZZ

Part No.	Description	Qty	Specs
36	Right Crank	1	170*15
37	Outer Spring	4	42
38	Crank Drive Assembly	2	80*65
39	Cover	2	56*23.6*24.6
40	Cover	2	58*36.3*22.7
41	Screw 1	6	GB/T 845-1985 ST4.2*19
42	Screw 2	14	GB/T 845-1985 ST4.2*19
43	Screw 3	6	GB/T 845-85 ST4.8*19
44	Chain Cover 1	1	478*270*60
45	Chain Cover 2	1	469*241*23
46	Axis	1	Φ20*162
47	Bolt 7	6	M4*12
48	Bolt 8	1	M5*18
49	Chain Cover	1	146*65*73
50	Short Chain Wheel	1	P=12.7, 66
51	Belt Wheel	1	P=12.7, Z=52T
52	Front Cover	1	122*56*45
53	Handle Base	1	41.5*30*30
54	Lock Nut	2	M33*1*4
55	Chain Wheel 1	1	A7K-161/2"*1/8" 16T (1.37")
56	Wheel	2	Φ75*24
57	Fixing Nut	1	M20*1.0
58	Fixing Nut 2	3	M12x1.25 H=6
59	Bearing	4	6001ZZ
60	Bearing	2	6004ZZ
61	Rim Assembly	1	Φ640*69
62	Flywheel Shaft	2	Φ12*160
63	Double Drive Assembly	1	Φ110*107
64	Double Drive Inner Sleeve	1	Φ116*Φ12.2*91.1
65	Belt	1	5PK1346
66	Chain Cover 3	1	248*269*80
67	Short Fixing Tube	1	Φ25*Φ20.5*9
68	Bolt 1	2	GB/845-85 M4*12
69	Handle	1	79*32*32.6
70	Flywheel Outer Tube	1	Φ16*Φ12.2*35
71	Flywheel Inner Casing	1	Φ16*Φ12.2*53.1
72	Bottle Holder	1	Φ6
73	Screw 3	2	GB/T 5780-2000 M5*10
74	Left Wheel Cover	1	Φ690*55
75	Right Wheel Cover	1	Φ690*55

Part No.	Description	Qty	Specs
76	Fan Baffle	1	Φ170*10
77	Handle Rotary Copper Sleeve	1	Φ12*20
78	Bolt 3	2	M10*45
79	Nut	4	GB/T 889.1-2000 M10
80	Bolt 16	1	M6*35
81	Handle Cover	1	Φ16.4*10.3*5.5
82	Little Rubber	1	19.6*15.6*13.7
83	Computer	1	SI-8210
84	Universal Joint	2	70*28 (M10)
85	Foot Lever	2	Φ38*110 (M16*1.5)
86	Bearing	4	6203ZZ
87	Foot lever	2	Φ22*110 (M16*1.5)
88	Foot Lever Bushing	2	Φ24* Φ17.2*11.1
89	Small Retaining Plate	4	Φ3
90	Corrugated Gasket	4	Φ20
91	Fixing Nut 1	1	M12x1.25 H-10
92	Nut	2	GB/T 889.1-2000 M16 H=12
93	Bearing	4	608ZZ
94	Fan Baffle	1	Φ17010
95	Spring Washer	4	GB/T 859-1987 10
96	Spring Wasjer 2	10	GB/T 859-1987 8
97	Belt Wheel	1	Φ200*24
98	Plastic Plug	1	Φ14*14

V. ASSEMBLY INSTRUCTIONS

PREPARATION

- A. Before assembling make sure that you will have enough space around the item.
- B. Use the present tooling for assembling.
- C. Before assembling please check whether all needed parts are available (at the above of this instruction sheet you will find an explosion drawing with all single parts (marked with numbers) which this item consists of.

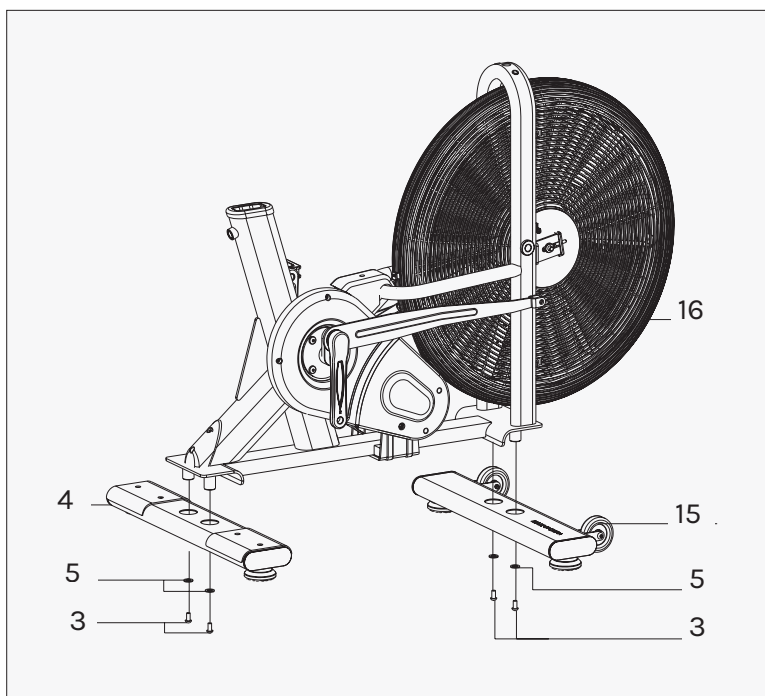

STEP 1

1. Attach the Front Stabilizer (pt.15) to the Main Frame (pt.16) using two sets of Ø10 Flat Washers (pt.5) and bolt 1 (3).
2. Attach the Rear Stabilizer (pt.4) to the Main Frame (pt.16) using two sets of Ø10 Flat Washers (pt.5) and bolt 1 (3).

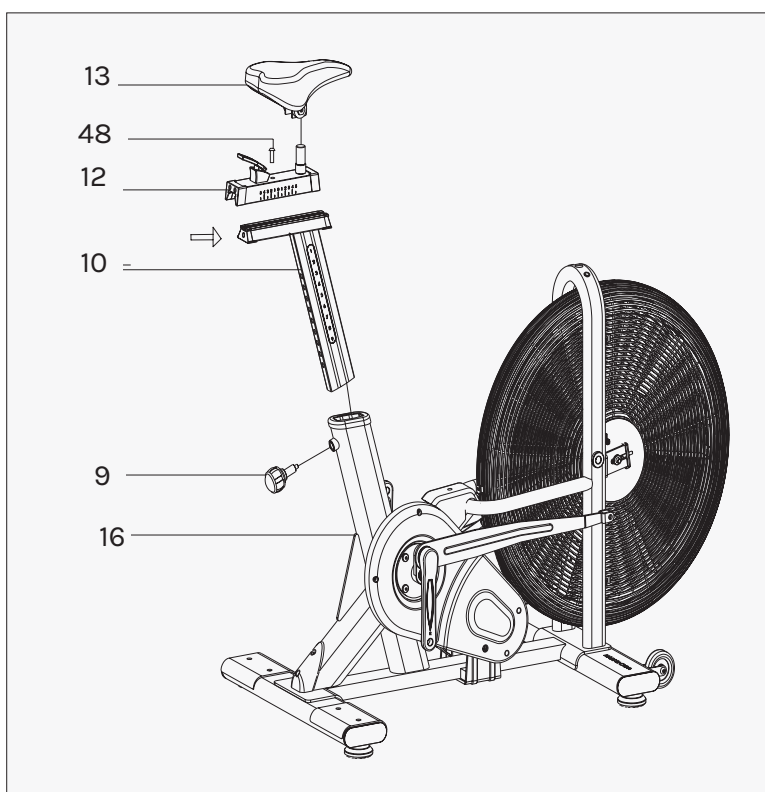

STEP 2

1. Slide the Vertical Seat Post (pt.10) into the seat post housing on the main frame (pt.16) and put the knob up then release the round nut (pt.48). Slide the Seat Post (pt.12) into the Vertical Seat Post (pt.10), then tighten the bolt 48 (pt.48). You will have to slacken the knurled section of the Adjustment Knob (pt.9) and pull the knob back and then select the desired height. Release the knob and retighten the knurled portion.
2. Now fix the Seat (pt.13) to the Seat Post (pt.12) as shown and tighten the bolts around the screws under the seat.

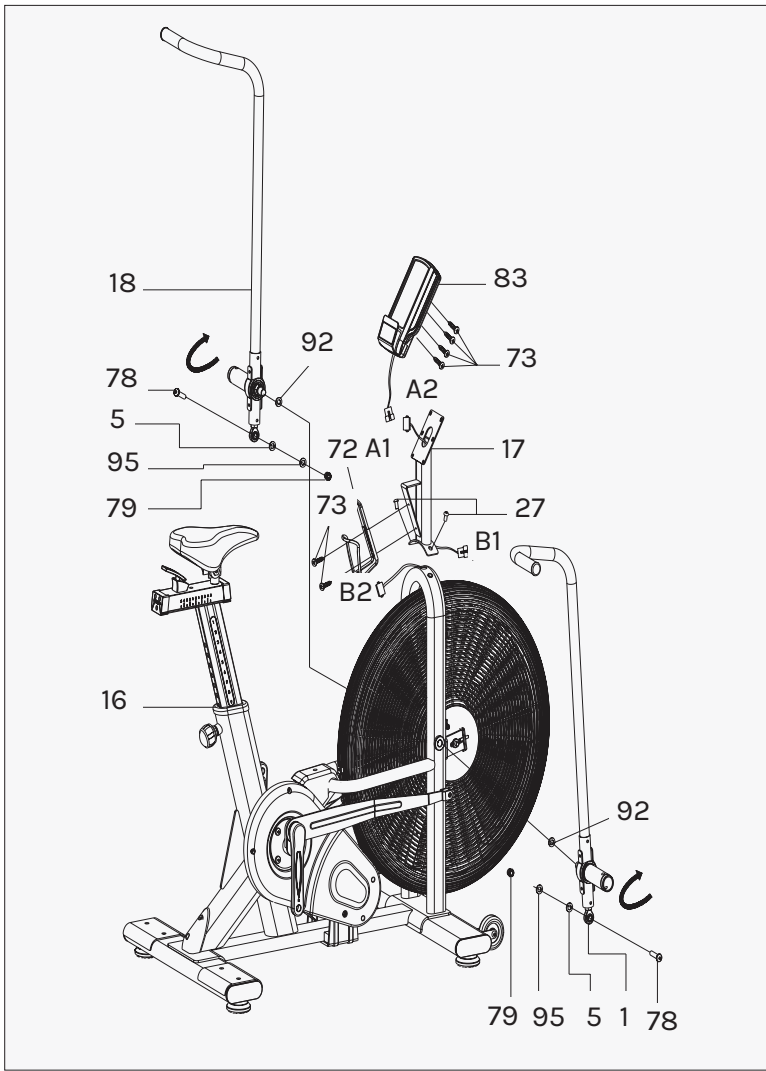

STEP 3

1. Assemble the left handlebar (18) and the right handlebar (21) with fixing nut (92) to the main frame (16), along with the inner six angle flat head screws (78), flat washer (5), spring washer (95), and the lock nut (79) in order as pictured in fig.3.
2. Connect the electronic connection (17) with six angle flat head screws (27) fixed to the main frame assembly (16). Plug cables B1 and B2 together.
3. Connect the bottle holder to the frame with screw 3 (73).
4. Plug cables A1 and A2 together and connect the computer (83) with universal joint (84) to electronic connection (17).

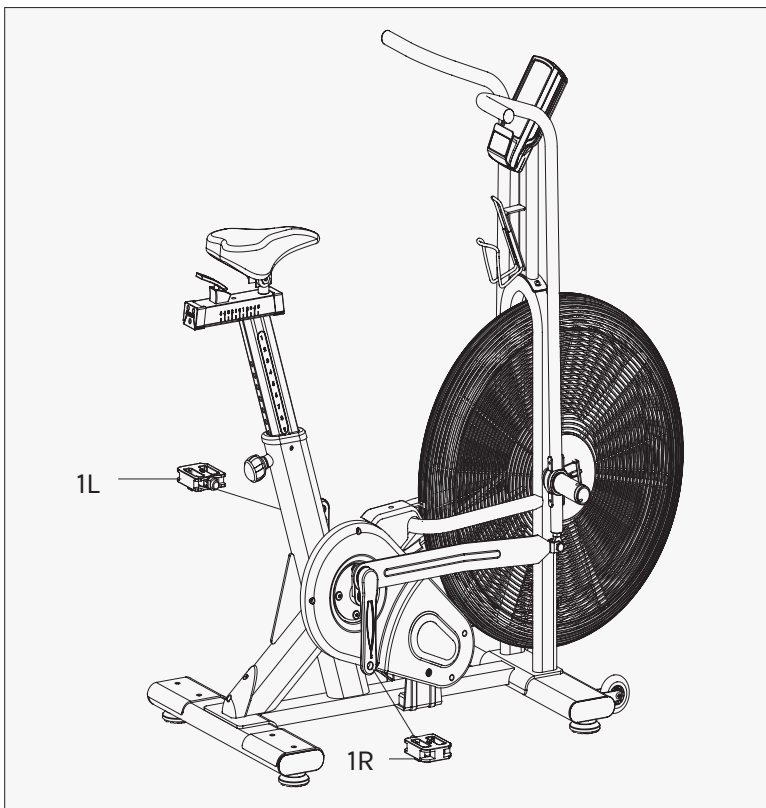

STEP 4

1. The Pedals (pt.1 L & pt.1 R) are marked "L" and "R" - Left and Right. Connect them to their appropriate crank arms. The right crank arm is on the right- hand side of the cycle as you sit on it. Note: The Right pedal should be threaded on clockwise and the Left pedal anticlockwise.

Adjusting Seat Height

For effective exercise, the seat should be at the proper height. As you pedal, there should be a slight bend in your knees when the pedals are in the lowest position.

To adjust the seat, first loosen the seat post knob a few turns (Counter-clockwise) and pull it outward. Next, slide the seat post upward or downward to the desired position, and release the seat post knob into an adjustment hole in the seat post. Then, tighten the seat post knob (Clockwise). Move the seat post upward or downward slightly to make sure that the seat post knob is engaged in one of the adjustment holes.

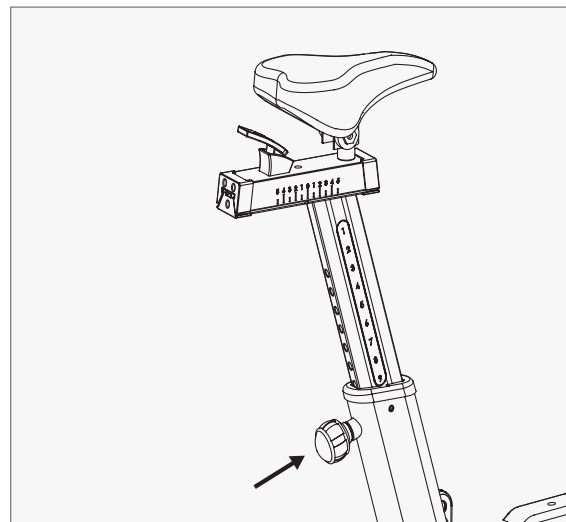

Adjusting Horizontal Position of the Seat

To adjust the horizontal position of the seat, pull up the lever under the seat to unlock. Move the position forward or backward to your liking then push the lever back down to lock it in place.

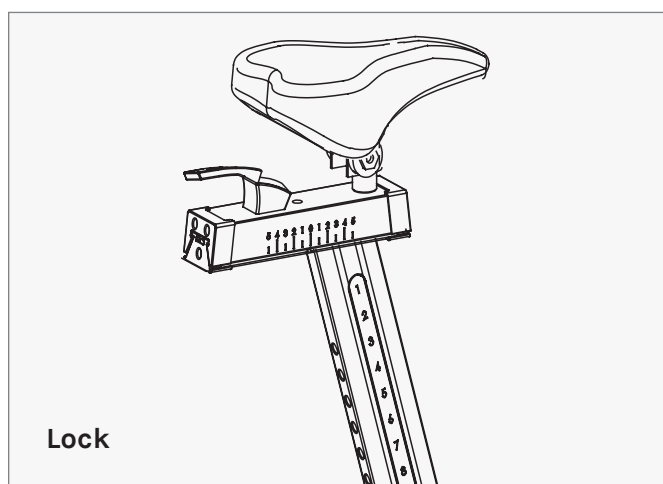
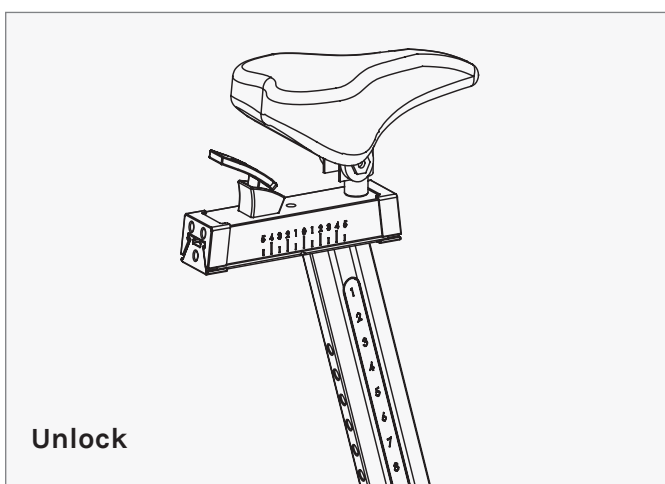

How to Level The Exercise Bike

There is two levelling feet at the front and two at the back. If the exercise bike rocks slightly on your floor during use, turn one or both leveling feet on the rear or front stabilizer clockwise (so it touches the floor) until the rocking motion is eliminated.

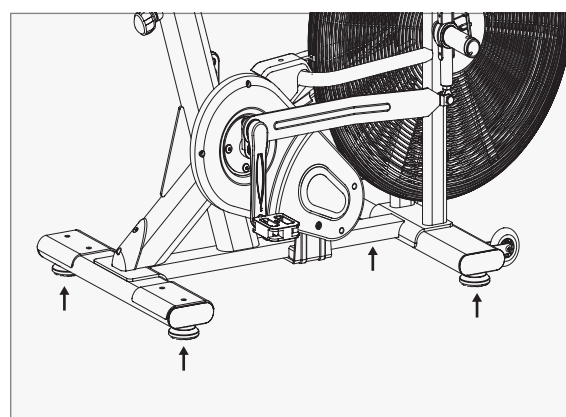

VI. COMPUTER OPERATION

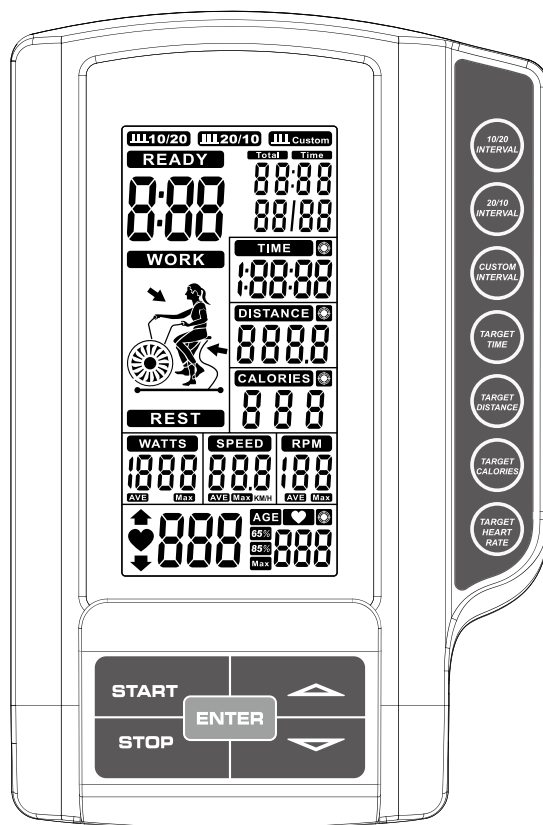

DISPLAY FUNCTION

ITEM	DESCRIPTION
RPM	Display the rotation per minute with range from 0~199.
SPEED	Display current training speed. Maximum speed is 99.9 KM/H or ML/H.
TIME	<ul style="list-style-type: none"> - Count up - No preset target, Time will count up from 00:00 to maximum 1:59:59 with each increment is 1 minute. - Count down - The console will countdown from preset time to 00:00:00 and each preset increment or decrement will be 1 minute between 00:01:00 to 1:59:00.
DISTANCE	Accumulates total distance from 0.0 up to 999.9 KM or ML or count down from preset value. User may preset target distance value with UP/DOWN key. Each increment is 1.0KM or ML.
CALORIES	Accumulates calories consumption or count down during training from 0 to maximum 999 calories. User may preset target Calories with UP/DOWN key.
WATT	<ul style="list-style-type: none"> - Display the power consumption during training. - Display Range: 0~1999.
Pulse	User may set up target pulse value from 0~30 to 230 and the console buzzer will beep when the actual heart rate is over the target value during workout.

BUTTON FUNCTIONS

ITEM	DESCRIPTION
START	To start work-out quickly or resume workout in Stop mode.
STOP	- To stop/pause workout. - To clear up all settings. - Hold on this key for 2 seconds to reboot the console.
DOWN	To adjust Distance, Calories, Heart-rate, Time, Age value down.
UP	To adjust Distance, Calories, Heart-rate, Time, Age value up.
Target Distance	Fast access to Target Distance training mode.
Target Calories	Fast access to Target Calories training mode.
Target Heart-rate	Fast access to Target Heart Rate training mode.
Target Time	Fast access to Target Time training mode.
Interval	There are 3 programs: INTERVAL 10/20, INTERVAL 20/10, Custom.
ENTER	To confirm settings or enter program.

OPERATION INSTRUCTIONS

- When POWER ON, LCD will full display 2s (Figure 1) with long beep sound, then display wheel diameter 1s in DIST area (Figure 2). Then enter into AGE setting mode, the AGE flashing to be set (Figure 3). Press the UP/DOWN to set age and press ENTER to confirm then go to Standby mode.

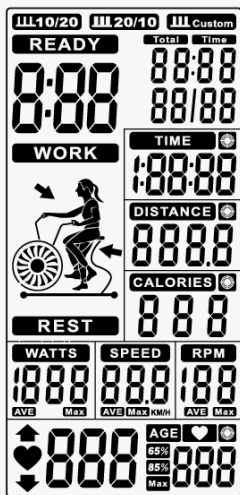

Figure 1

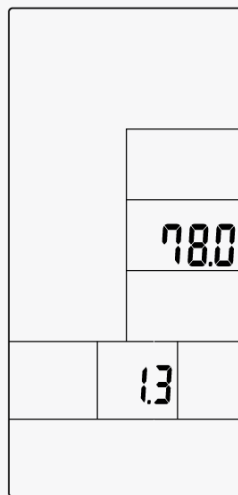

Figure 2

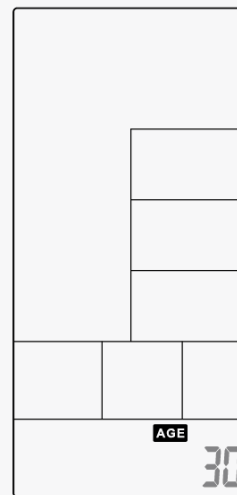

Figure 3

2. The window of INTERVAL10/20, INTERVAL10/20, INTERVAL CUSTOM, READY, WORK, REST, TIME, DISTANCE, CALORIES, WATTS, SPEED, RPM and will flash by sequence in every 1s (Figure 4~Figure 16). If no input of key operation or RPM signal or pulse input for 60s, computer will go to Sleeping mode.

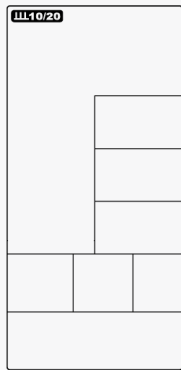

Figure 4

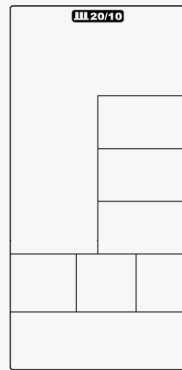

Figure 5

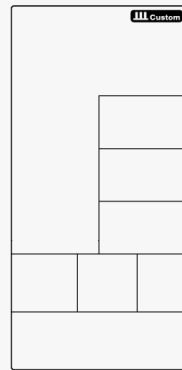

Figure 6

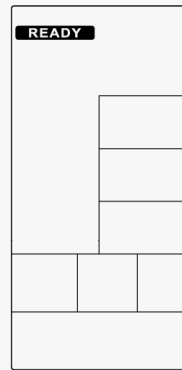

Figure 7

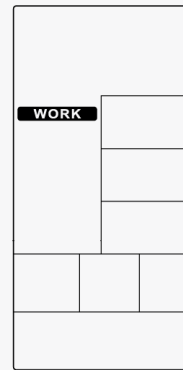

Figure 8

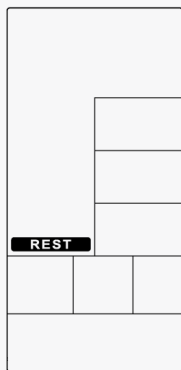

Figure 9

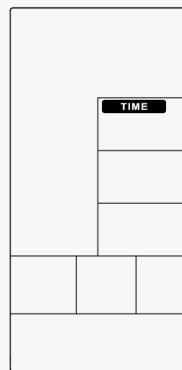

Figure 10

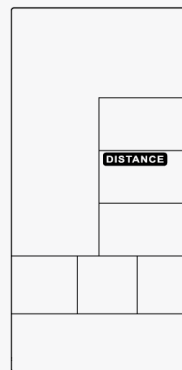

Figure 11

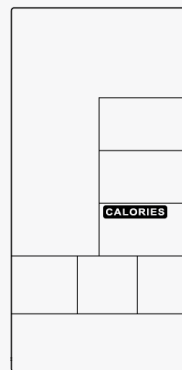

Figure 12

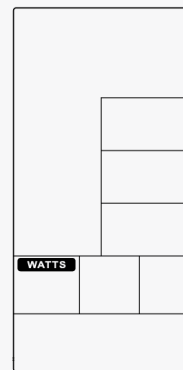

Figure 13

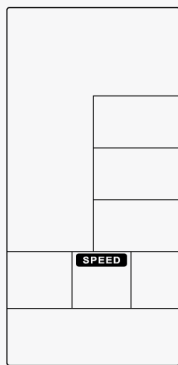

Figure 14

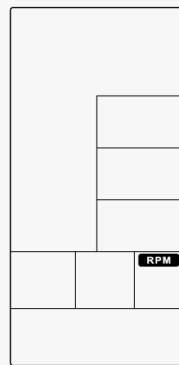

Figure 15

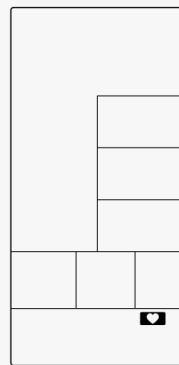

Figure 16

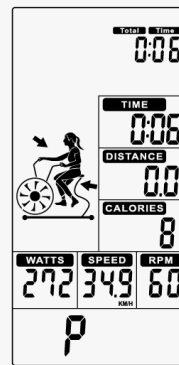

Figure 17

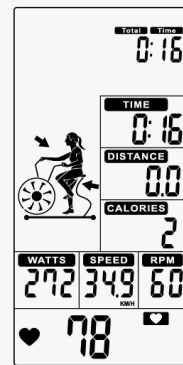

Figure 18

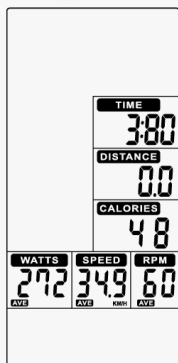

Figure 19

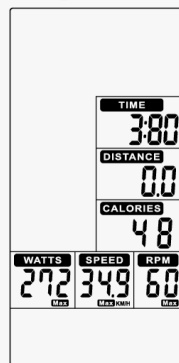

Figure 20

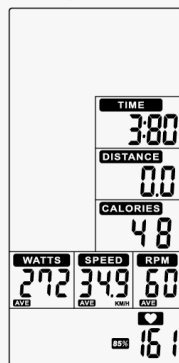

Figure 21

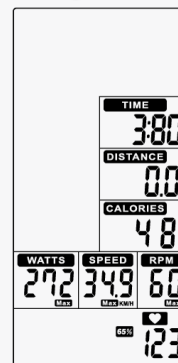

Figure 22

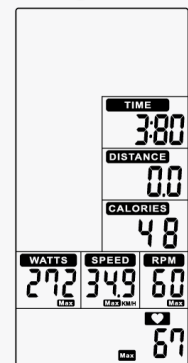



Figure 23

3. Select Manual, Interval, Target Distance, Target Calories, Target HR, Target Time program

3.1 Manual mode

1. In Standby mode, press START to start work out quickly, the buzzer sound 1 second. TOTAL TIME/ TIME DISTANCE/ CALORIES/ WATTS/ SPEED/ RPM start to count up (Figure 17).
2. Whenever there is Pulse signal input,  will light up and  symbol will flash and display pulse value (Figure 18). Without pulse input, it will display "P" (Figure 17).
3. No signal input for 30s, buzzer sounds 1 short beep and enter to Wake-up mode. Press any to wake up the console.
4. Press START key once to pause training, Buzzer will sound for 0.5s in every 30s. All values are displaying on LCD and flashing in every 4s. If continue to stop training for 5 minutes, buzzer sounds 2s and enter to Wake-up mode. Press START to resume workout.
5. Press STOP key, TIME will display total workout time; DISTANCE will display total workout distance; CALORIES will display total consumption during workout; WATT, SPEED and RPM will switch to display AVG. & MAX. in every 5s.
6. With pulse signal input, PULSE window will display user actual pulse and 65%, 85% MAX (Figure 21~23). Pulse window displays nothing if no pulse signal input (Figure 19~20).
7. Press any PROGRAM key then perform the program accordingly.

3.2 Interval 20/10 mode

1. Press INIERVAL key to select INTERVAL20/10, press ENTER then INTERVAL20/10 will light up, along with a long sound for 1s.
2. Cycle time counts down from 3 to 0 then console start, meanwhile buzzer beeps once per second and READY flashes once per second, counting displays '00/08' (Figure 24).
3. Cycle time counts down from 20 to 0 and WORK flashes once per second along with 20 beeps. Meantime windows displays rotation animation and count down from 4 minutes. Then TOTAL TIME, DISTANCE, CALORIES, WATTS, SPEED & RPM start calculating, counting displays '01/08' (Figure 25).
4. Cycle time counts down from 10 to 0 and REST flashes once per second along with 10 beeps(Figure 26), meanwhile READY will flash in last 3s (Figure 27).
5. The above 3 & 4 continue cycle counting and add 1 per each cycle, until displays 08/08WORK, then go to End page.
6. Press START button once enter into PAUSE mode, Buzzer will sound for 0.5s in every 30s. All values are displaying on LCD and flashing in every 4s. If continue to stop training for 5 minutes, buzzer sounds 2s and enter to Wake-up mode. Press START to resume workout.
7. Press STOP or end up training, buzzer beeps 1s then displays TOTAL TIME, DISTANCE,CALORIES for 30s, and WATT, SPEED & RPM will switch to display AVG. & MAX. each 5s.v
8. With pulse signal input, PULSE window will display user actual pulse and 65%, 85% MAX (Figure 21~23). Pulse window displays nothing if no pulse signal input (Figure 19~20).
9. Press any PROGRAM key then perform the program accordingly.

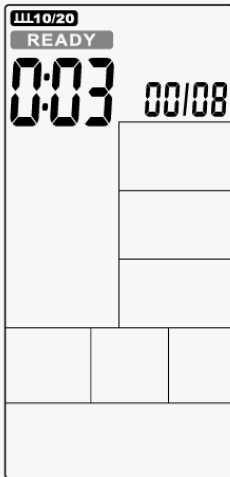

Figure 24

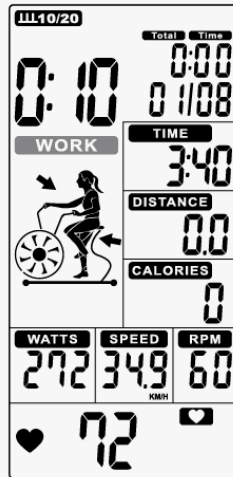

Figure 25



Figure 26



Figure 27

3.3 Interval 10-20 mode

1. Press INTERVAL to select INTERVAL10/20, press ENTER then INTERVAL10/20 will light up along with buzzer beeps 1s.
2. Cycle time counts down from 3 to 0 then console start, meanwhile buzzer beeps once per second and READY flashes once per second, counting displays '00/08'(Figure 28).
3. Cycle time counts down from 10 to 0 and WORK flashes once per second along with 20 beeps. Meantime REMAINING will light up and count down from 4 minutes. Then TOTAL TIME, DISTANCE, CALORIES, WATTS, SPEED & RPM start calculating, counting displays '01/08' (Figure 29).
4. Cycle time counts down from 20 to 0 and REST flashes once per second along with beeps (Figure 30), meanwhile READY will flash in last 3s(Figure 31).
5. The above 3 & 4 continue cycle counting and add 1 per each cycle, until displays 08/08WORK, then go to End page.
6. Press START button once enter into PAUSE mode, Buzzer will sound for 0.5s in every 30s. All values are displaying on LCD and flashing in every 4s. If continue to stop training for 5 minutes, buzzer sounds 2s and enter to Wake-up mode. Press START to resume workout.
7. Press STOP or end up training, buzzer beeps 1s then displays TOTAL TIME, DISTANCE,CALORIES for 30s, and WATT, SPEED & RPM will switch to display AVG. & MAX. each 5s.
8. With pulse signal input, PULSE window will display user actual pulse and 65%, 85% MAX (Figure 21~23). Pulse window displays nothing if no pulse signal input (Figure 19~20).
9. Press any PROGRAM key then perform the program accordingly.

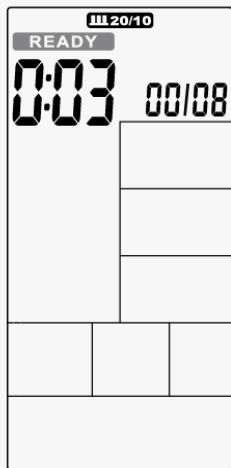

Figure 28

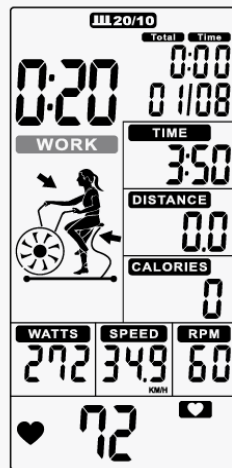

Figure 29



Figure 30

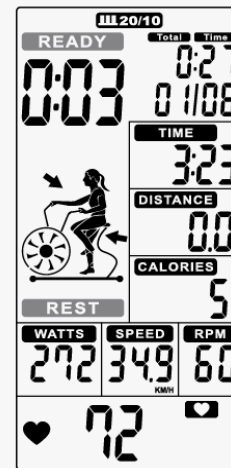

Figure 31

3.4 Interval CUSTOM

1. Press INTERVAL to select INTERVAL CUSTOM, press ENTER to enter into this mode then INTERVAL CUSTOM 00/XX flashes to be set along with buzzer beeps 1s. Press UP/DOWN to set 00/XX within 1~99 Circularly. Press ENTER to confirm along with buzzer beeps 1s then enter into next setting.(Figure 32).
2. The TIME continues lighting up, WORK and 0:01 will flash, press UP/DOWN to set training time within 0:00~9:59 circularly (Figure 34). Press ENTER to confirm along with buzzer beeps 1s and INTERVAL CUSTOM continues lighting up.
2. The TIME continues lighting up, REST will flash, press UP/DOWN to set rest time 0:01~9:59 circularly (Figure 34). Press ENTER to confirm along with buzzer beeps 1s and INTERVAL CUSTOM continues lighting up.
4. Cycle time counts down from 3 to 0 then console start, meanwhile buzzer beeps once per second and READY flashes once per second, counting displays '00/XX'(Figure 35).
5. Cycle time counts down from the preset total time and WORK flashes once per second along with buzzer beeps. Then TOTAL TIME, DISTANCE, CALORIES, WATTS, SPEED & RPM start calculating, counting displays '01/XX'(Figure 36).
6. Cycle time counts down from and REST flashes once per second along with buzzer beeps(Figure 37), meanwhile READY will flash in last 3s(Figure 38).
7. The above 3 & 4 continue cycle counting and add 1 per each cycle, until the WORK setting value finished then go to End page.
8. In WORK mode, buzzer beeps 1s then enter into wake up mode if no any signal inputs within 30s.
9. Press START button once enter into PAUSE mode, Buzzer will sound for 0.5s in every 30s. All values are displaying on LCD and flashing in every 4s. If continue to stop training for 5 minutes, buzzer sounds 2s and enter to Wake-up mode. Press START to resume workout.
10. Press STOP or end up training, buzzer beeps 1s then displays TOTAL TIME, DISTANCE,CALORIES for 30s, and WATT, SPEED & RPM will switch to display AVG. & MAX. each 5s.
11. With pulse signal input, PULSE window will display user actual pulse and 65%, 85% MAX (Figure 21~23). Pulse window displays nothing if no pulse signal input (Figure 19~20).
12. Press any PROGRAM key then perform the program accordingly.

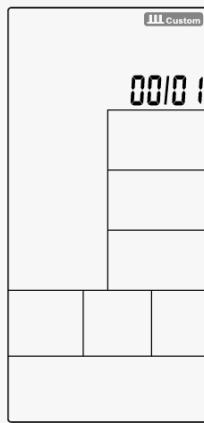

Figure 32

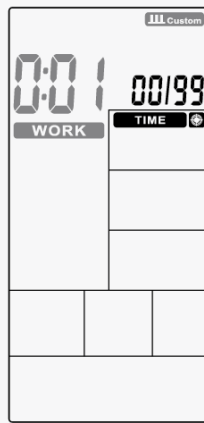

Figure 33

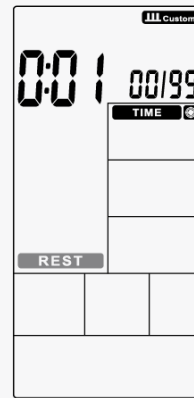

Figure 34

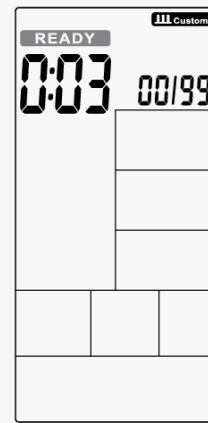

Figure 35

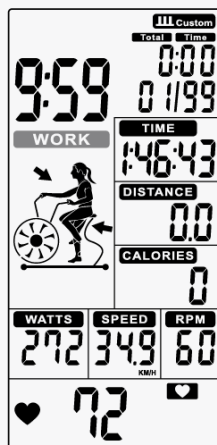

Figure 36





Figure 37



Figure 38

3.5 Target TIME mode

1. In Standby mode, press Target Time key and  will light up, along with a long sound for 1s.
2. TIME  value is flashing, press UP and DOWN to adjust value (Figure 39) and press ENTER to confirm meanwhile buzzer beeps 1s and TIME lasting lighting up.
3. Pre-set TIME value counts down, DISTANCE, CALORIES, WATTS, SPEED, RPM start to count up. (Figure 40)
4. Press START button once enter into PAUSE mode, Buzzer will sound for 0.5s per second within 30s. All values are displaying on LCD and flashing in every 2s. If continue to stop training for 5 minutes, buzzer sounds 2s and enter to Wake-up mode. Press START to resume workout.
5. No signal inputs for 30s, buzzer sounds 1 short beep and enter to Wake-up mode.
6. Press STOP or end up training, TIME will display total workout time; DISTANCE will display total workout distance; CALORIES will display total consumption during workout; WATT, SPEED and RPM will switch to display AVG. & MAX. in every 5s.
7. With pulse signal input, PULSE window will display user actual pulse and 65%, 85% MAX (Figure 21~23). Pulse window displays nothing if no pulse signal input (Figure 19~20).
8. Press any PROGRAM key then perform the program accordingly.

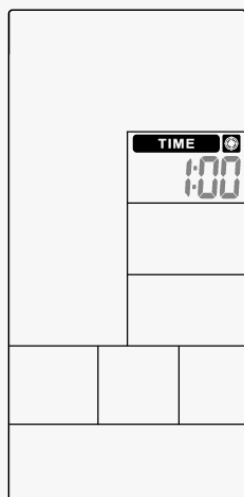

Figure 39

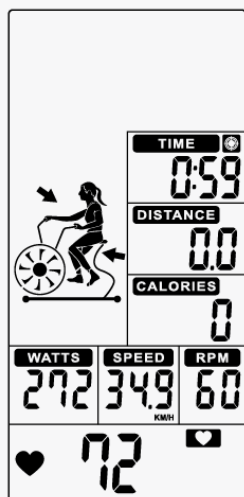

Figure 40

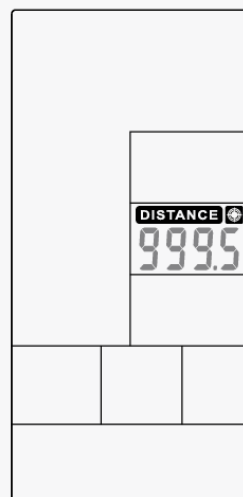

Figure 41

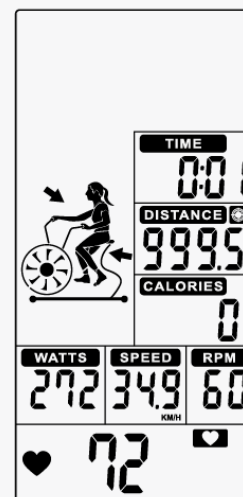



Figure 42

3.6 Target Distance mode

1. In Standby mode, press Target Distance key and TARGET DISTANCE will light up, along with a long sound for 1s.
2. DISTANCE  value is flashing, press UP and DOWN to adjust (Figure 41). Press ENTER to confirm meanwhile buzzer beeps 1s and TARGET DISTANCE lasting lighting up.
3. Pre-set DISTANCE value counts down, TIME, CALORIES, WATTS, SPEED, RPM start to count up. (Figure 42)
4. Press START button once enter into PAUSE mode, Buzzer will sound for 0.5s per second within 30s. All values are displaying on LCD and flashing in every 2s. If continue to stop training for 5 minutes, buzzer sounds 2s and enter to Wake-up mode. Press START to resume workout.
5. No signal input for 30s, buzzer sounds 1s and enter to Wake-up mode. minutes, buzzer sounds 2s and enter to Wake-up mode. Press START to resume workout.
6. Press STOP key or end up training, TIME will display total workout time; DISTANCE will display total workout distance. CALORIES will display total consumption during workout; WATT, SPEED and RPM will switch to display AVG. & MAX. PULSE window will switch to display 65%, 85% MAX (Figure 21~23) each 5s.
7. With pulse signal input, PULSE window will display user actual pulse and 65%, 85% MAX (Figure 21~23). Pulse window displays nothing if no pulse signal input (Figure 19~20).
8. Press any PROGRAM key then perform the program accordingly.

3.7 Target Calories mode

1. In Standby mode, press Target Calories key and TARGET CALORIE will light up, along with a long sound for 1s.
2. CALORIES value is flashing, press UP and DOWN to adjust (Figure 43). Press ENTER to confirm meanwhile buzzer beeps 1s and TARGET CALORIE lasting lighting up.
3. Pre-set CALORIES value counts down, TIME, DISTANCE, WATTS, SPEED & RPM start to count up. (Figure 44)

4. Press START button once enter into PAUSE mode, Buzzer will sound for 0.5s per second within 30s. All values are displaying on LCD and flashing in every 2s. If continue to stop training for 5 minutes, buzzer sounds 2s and enter to Wake-up mode. Press START to resume workout.
5. No signal input for 30s, buzzer sounds 1s and enter to Wake-up mode.
6. Press STOP key or end up training, TIME will display total workout time; DISTANCE will display total workout distance; CALORIES will display total consumption during workout; WATT, SPEED and RPM will switch to display AVG. & MAX. in every 5s.
7. With pulse signal input, PULSE window will display user actual pulse and 65%, 85% MAX (Figure 21~23). Pulse window displays nothing if no pulse signal input (Figure 19~20).
8. Press any PROGRAM key then perform the program accordingly.

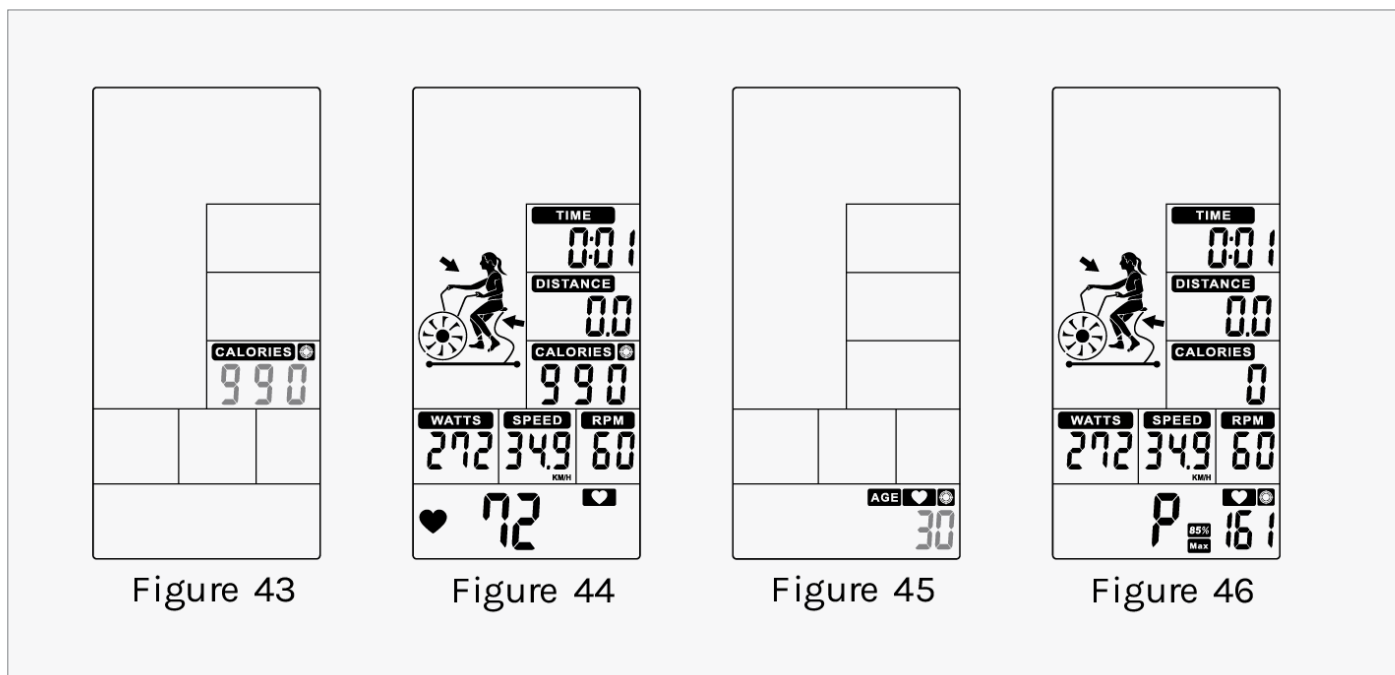

3.8 Target HR mode:

1. In Standby mode, press Target Heart-Rate key and **AGE** will light up, along with along sound for 1s.
2. AGE value is flashing, press UP and DOWN to pre-set your Age (Figure 45). Press ENTER to confirm along with buzzer beeps 1s and and HEART RATE last lighting up.
3. When start workout, MAX HR lights up, 65% & 85% Heart rate will switch to display. TIME/ DISTANCE/ CALORIES/ WATTS/ SPEED/ RPM will calculate workout value (Figure 46).
4. When Heart Rate goes below to 65%, & **65%** & value will flash. And buzzer sounds in every 10s until user HR achieve above 65% (Figure 47).
5. When Heart Rate exceeds to 85%, & **85%** & value will flash. And buzzer sounds in every 10s until user HR goes below 85% (Figure 48).
6. When Heart Rate goes between 65% ~ 85%, only will flash (Figure 49).
7. No signal input for 30s, buzzer sounds 1 short beep and enter to Wake-up mode.
8. Press START button once enter into PAUSE mode, Buzzer will sound for 0.5s per second within 30s. All values are displaying on LCD and flashing in every 2s. If continue to stop training for 5 minutes, buzzer sounds 2s and enter to Wake-up mode. Press START to resume workout.

9. Press STOP again or end up training in 15s, TIME will display total workout time; DISTANCE will display total workout distance; CALORIES will display total consumption during workout; WATT, SPEED and RPM will switch to display AVG. & MAX. in every 5s.
10. With pulse signal input, PULSE window will display user actual pulse and 65%, 85% MAX (Figure 21~23). Pulse window displays nothing if no pulse signal input (Figure 19~20).
11. Press any PROGRAM key then perform the program accordingly.

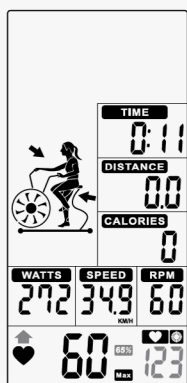

Figure 47

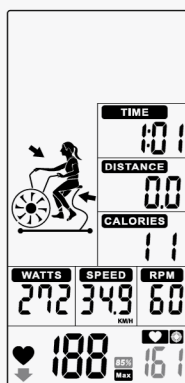

Figure 48

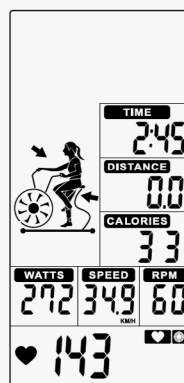

Figure 49

OPTION SETTING

SETTING mode

1. Hold on STOP & ENTER key for 2s, buzzer will sound 1 long beep. DISTANCE keep lighting up, M/KM flash once per second (Figure 50~51).
2. Press UP or DOWN to select KM or ML, press ENTER to confirm then skip to Standby mode.
3. No action to console for 30s, it will go to Standby mode.

RESET Mode

1. In any mode, press STOP for 2s, system will do TOTAL RESET.
2. LCD flash in every 2 seconds, buzzer sound for 2 seconds.
3. Reverse to Standby page, all setting resume to preset value.

SLEEPING mode

In Standby mode, if no key press/RPM/pulse input for 30s, console will go to SLEEPING mode.

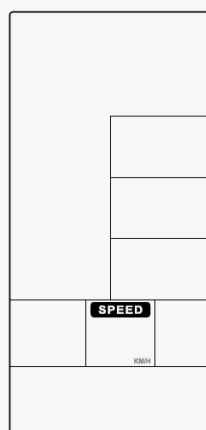

Figure 50

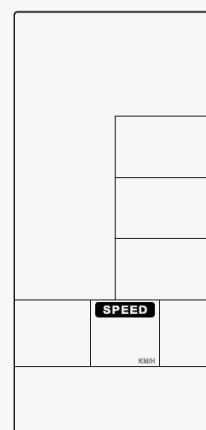

Figure 51

VII. EXERCISE GUIDE

! PLEASE NOTE:

Before beginning any exercise program, consult your physician. This is important especially if you are over the age of 45 or individuals with pre-existing health problems.

The pulse sensors are not medical devices. Various factors, including the user's movement, may affect the accuracy of heart rate readings. The pulse sensors are intended only as an exercise aid in determining heart rate trends in general.

Exercising is great way to control your weight, improving your fitness and reduce the effect of aging and stress. The key to success is to make exercise a regular and enjoyable part of your everyday life.

The condition of your heart and lungs and how efficient they are in delivering oxygen via your blood to your muscles is an important factor to your fitness. Your muscles use this oxygen to provide enough energy for daily activity. This is called aerobic activity. When you are fit, your heart will not have to work so hard. It will pump a lot fewer times per minute, reducing the wear and tear of your heart.

So as you can see, the fitter you are, the healthier and greater you will feel.

WARM UP

Start each workout with 5 to 10 minutes of stretching and some light exercises. A proper warm-up increases your body temperature, heart rate and circulation in preparation for exercise. Ease into your exercise.

After warming up, increase the intensity to your desired exercise program. Be sure to maintain your intensity for maximum performance. Breathe regularly and deeply as you exercise.

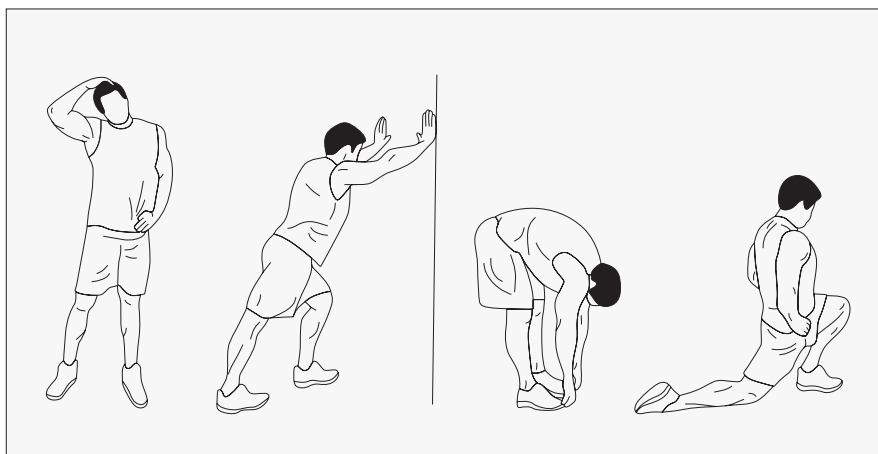

COOL DOWN

Finish each workout with a light jog or walk for at least 1 minute. Then complete 5 to 10 minutes of stretching to cool down. This will increase the flexibility of your muscles and will help prevent post-exercise problems.

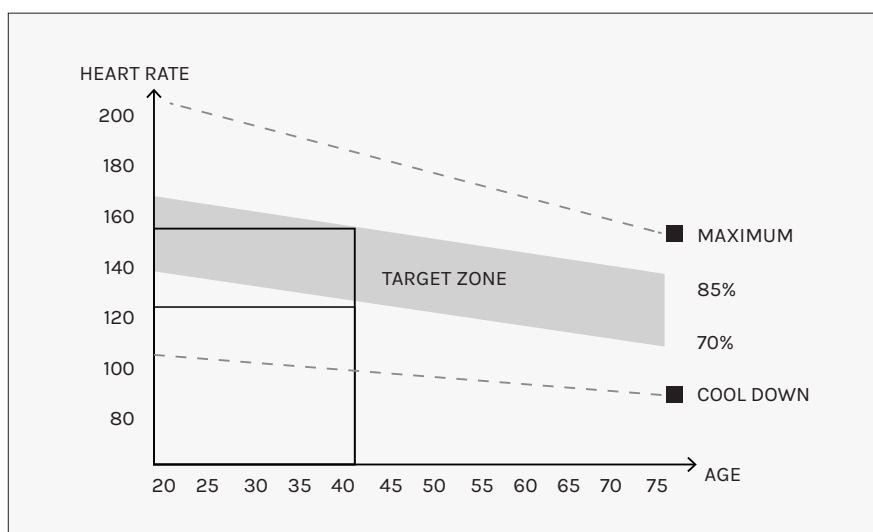

WORKOUT GUIDELINES

! This is how your pulse should behave during general fitness exercise. Remember to warm up and cool down for a few minutes.

VIII. WARRANTY

AUSTRALIAN CONSUMER LAW

Many of our products come with a guarantee or warranty from the manufacturer. In addition, they come with guarantees that cannot be excluded under the Australian Consumer Law. You are entitled to a replacement or refund for a major failure and compensation for any other reasonably foreseeable loss or damage.

You are entitled to have the goods repaired or replaced if the goods fail to be of acceptable quality and the failure does not amount to a major failure. Full details of your consumer rights may be found at www.consumerlaw.gov.au.

Please visit our website to view our full warranty terms and conditions:
<http://www.lifespanfitness.com.au/warranty-repairs>

WARRANTY AND SUPPORT

Any claim against this warranty must be made through your original place of purchase. Proof of purchase is required before a warranty claim may be processed.

If you have purchased this product from the Official Lifespan Fitness website, please visit <https://lifespanfitness.com.au/warranty-form>

For support outside of warranty, if you wish to purchase replacement parts or request a repair or service, please visit <https://lifespanfitness.com.au/warranty-form> and fill in our Repair/Service Request Form or Parts Purchase Form.

Scan this QR code with your device to go to lifespanfitness.com.au/warranty-form





WWW.LIFESPANFITNESS.COM.AU