

# owner's manual

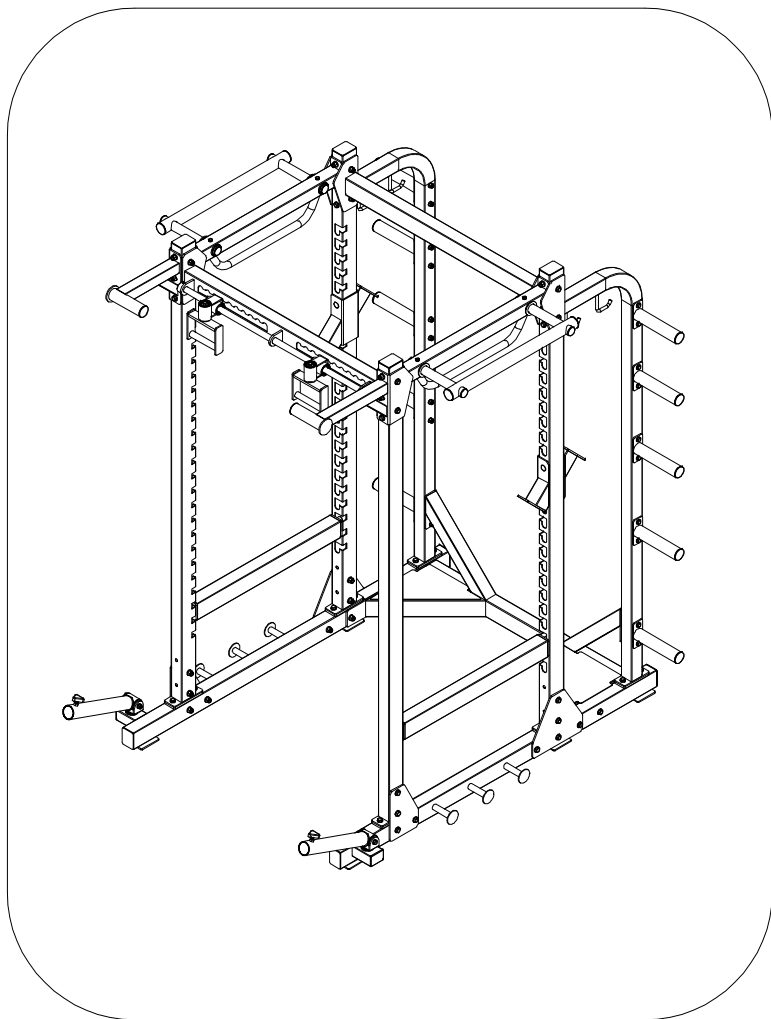

## Important Safety Information









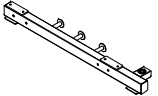
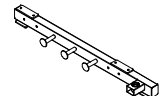
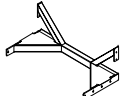
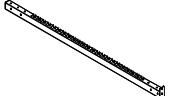
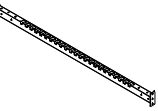

※※※Please read operation manual carefully※※※

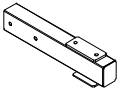
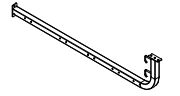
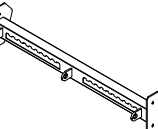
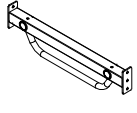
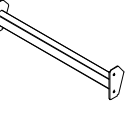
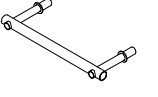
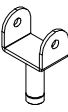
1. Please keep the box and the manual after installing the machine.
2. Check the stability of the bolts regularly.
3. Please install the machine in a commodious place.
4. Put the machine on the level ground, and use a mat to protect the floor.
5. Please consult to your doctor, physician before using any exercise equipments.
6. There are slip proof cover on the nut (little nylon circle on the nut); please tighten them with wrench.
7. The product is only for Domestic use not for Commercial purposes.
8. Please tighten the screws; otherwise it might be dangerous to use.
9. Please do not alter the machine in any way it might be dangerous to change and mend the machine.
10. Store in the place where is away from moisture, salt (near Pool) high temperature and under sun.
11. For maintenance and cleaning exercise machines Please clean the dirt with detergent scour, using dry rag and clean water (do not use gas, dilution and other chemicals).
12. Do not put your hands in the moving part of the machine when you are doing exercise.

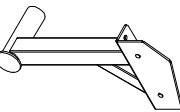
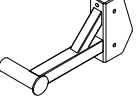

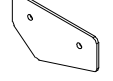

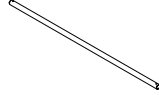

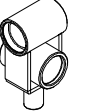
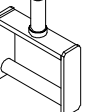
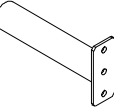

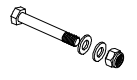
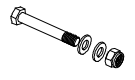
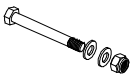
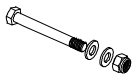

Thank you for choosing our Fitness products, We hope you enjoy using and you get maximum benefit of it.

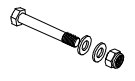
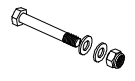

PART LIST

			
A 1 PC	B 1 PC	C 1 PC	D 2 PCS
			
E 2 PCS	F 2 PCS	G 2 PCS	H 2 PCS
			
I 1 PC	J 2 PCS	K 1 PC	L 2 PCS
			
M 2 PCS	N 2 PCS	O 2 PCS	P 1 PC
			
Q 1 PC	R 1 PC	S 1 PC	T 2 PCS
			
U 2 PCS	V 1 PC	W 2 PCS	X 2 PCS
			
Y 2 PCS	Z 10 PCS		

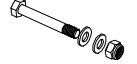
PART LIST

M12*80 bolt, nut, washer	M12*85 bolt, nut, washer	M12*105 bolt, nut, washer	M12*100 bolt, nut, washer
			
1 16 PCS	2 10 PCS	3 6 PCS	4 6 PCS
M12*85 bolt, washer	M12*20 bolt, washer	M10*20 bolt, washer	M6*20 bolt
			
5 2 PCS	6 12 PCS	7 2 PCS	8 2 PCS
M10*20 bolt, washer	M10*90 bolt, nut, washer	M10*80 bolt, nut, washer	M10*85 bolt, washer
			
9 4 PCS	10 2 PCS	11 16 PCS	12 2 PCS
M10*85 bolt, nut, washer			
			
13 2 PCS	14 2 PCS		

# The composing of accessories

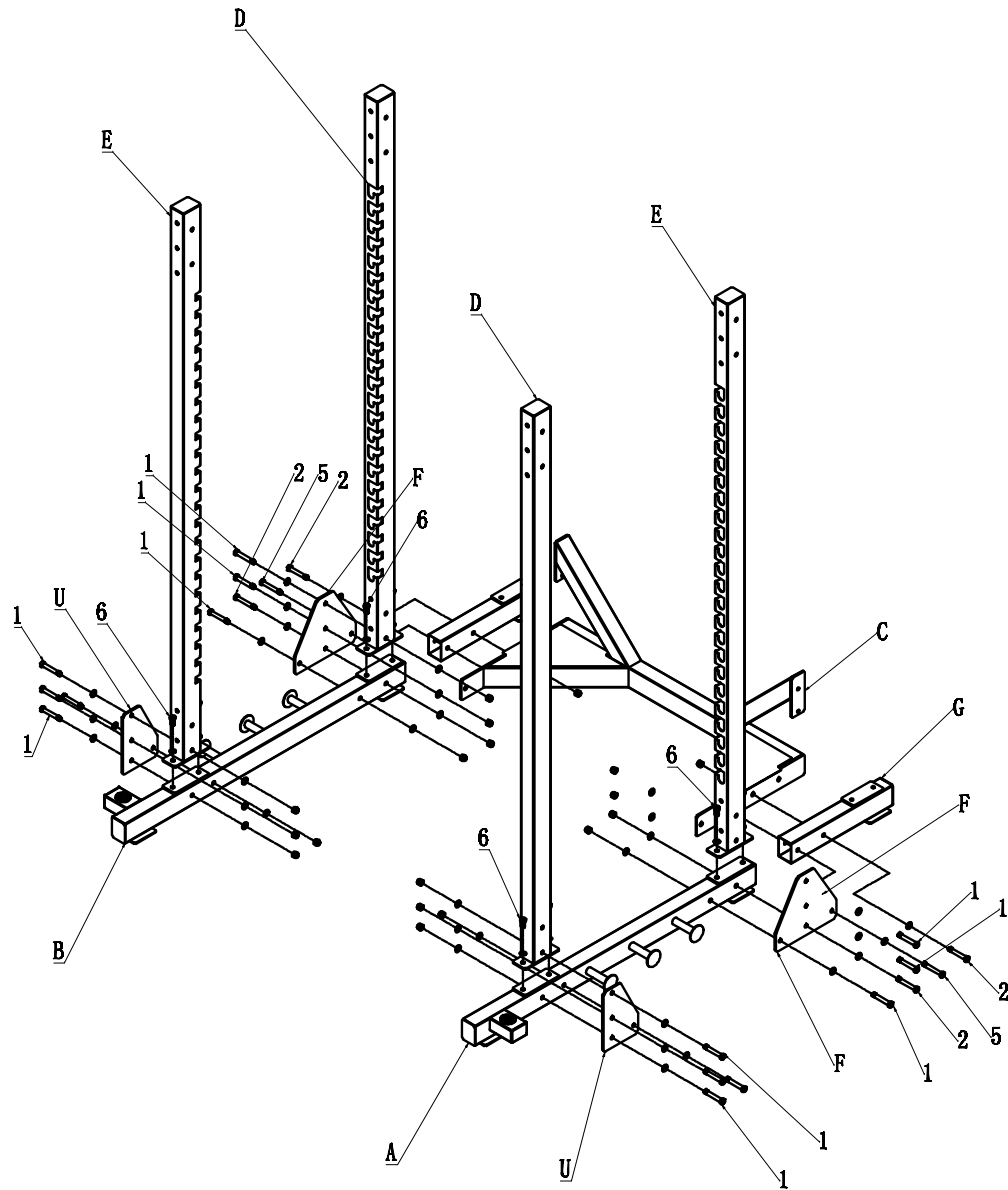

※ there is anti-slip nylon damp please strenthen it in tool.

1

# The composing of accessories

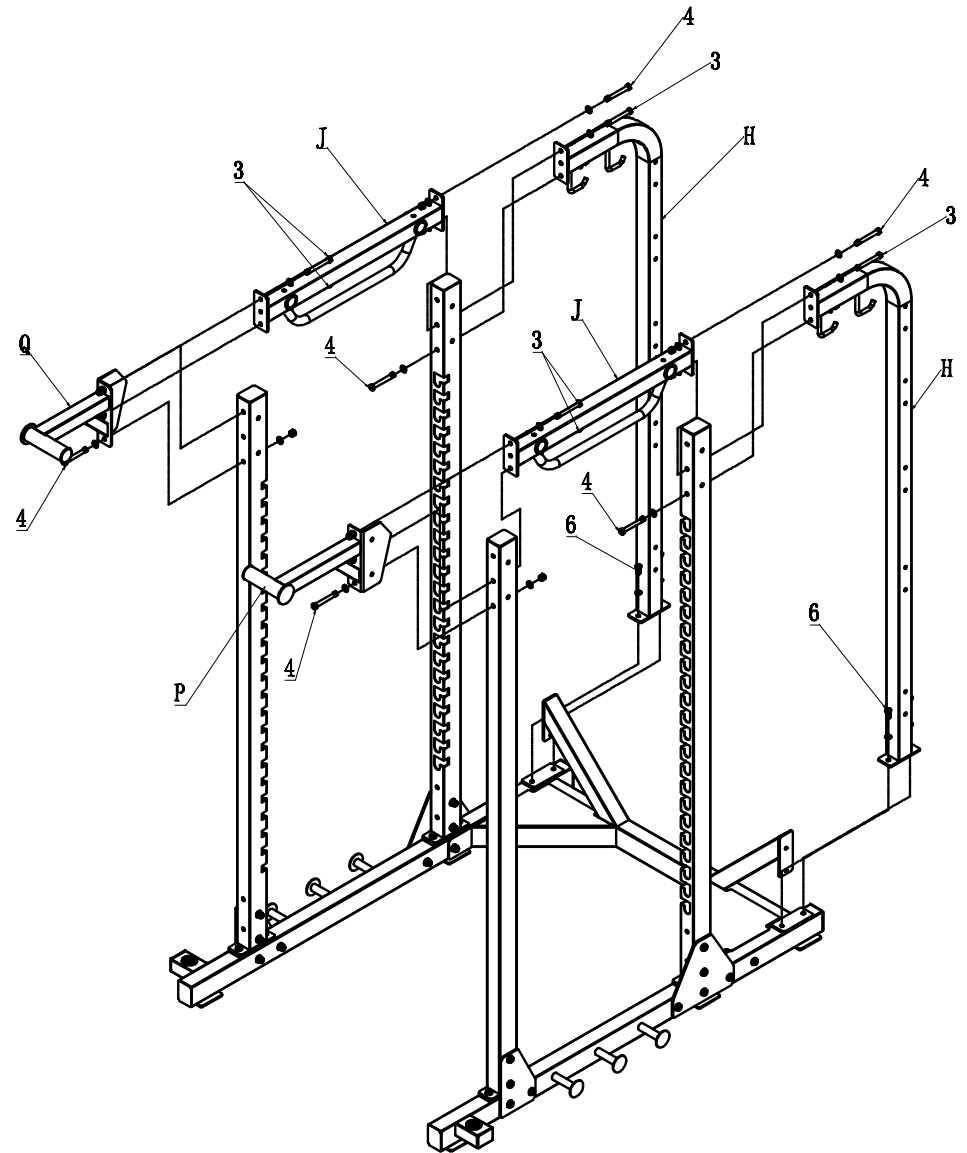

※ there is anti-slip nylon damp please strenthen it in tool.

2

### The composing of accessories

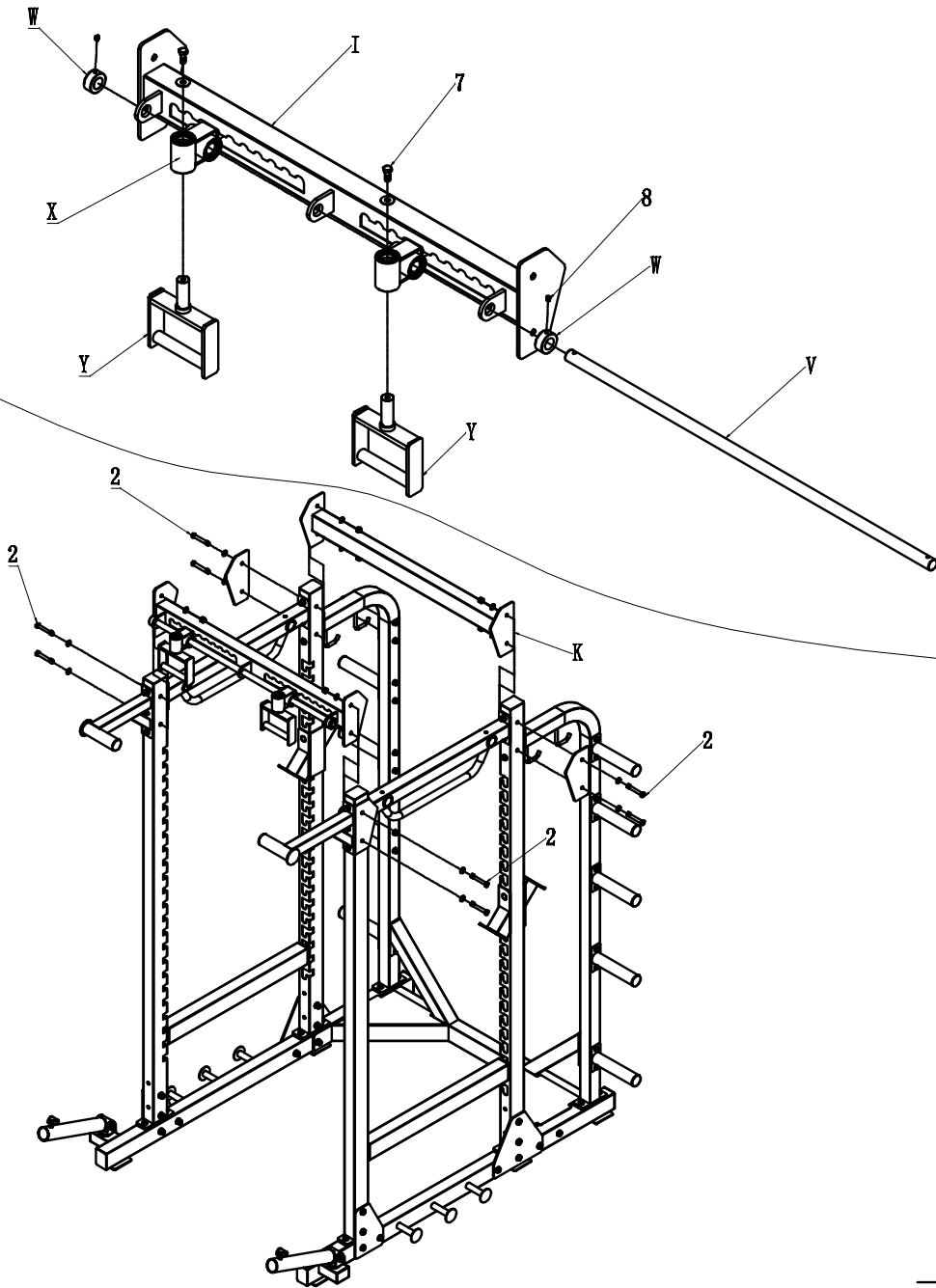

※ there is anti-slip nylon damp please strenthen it in tool.

3

### The composing of accessories

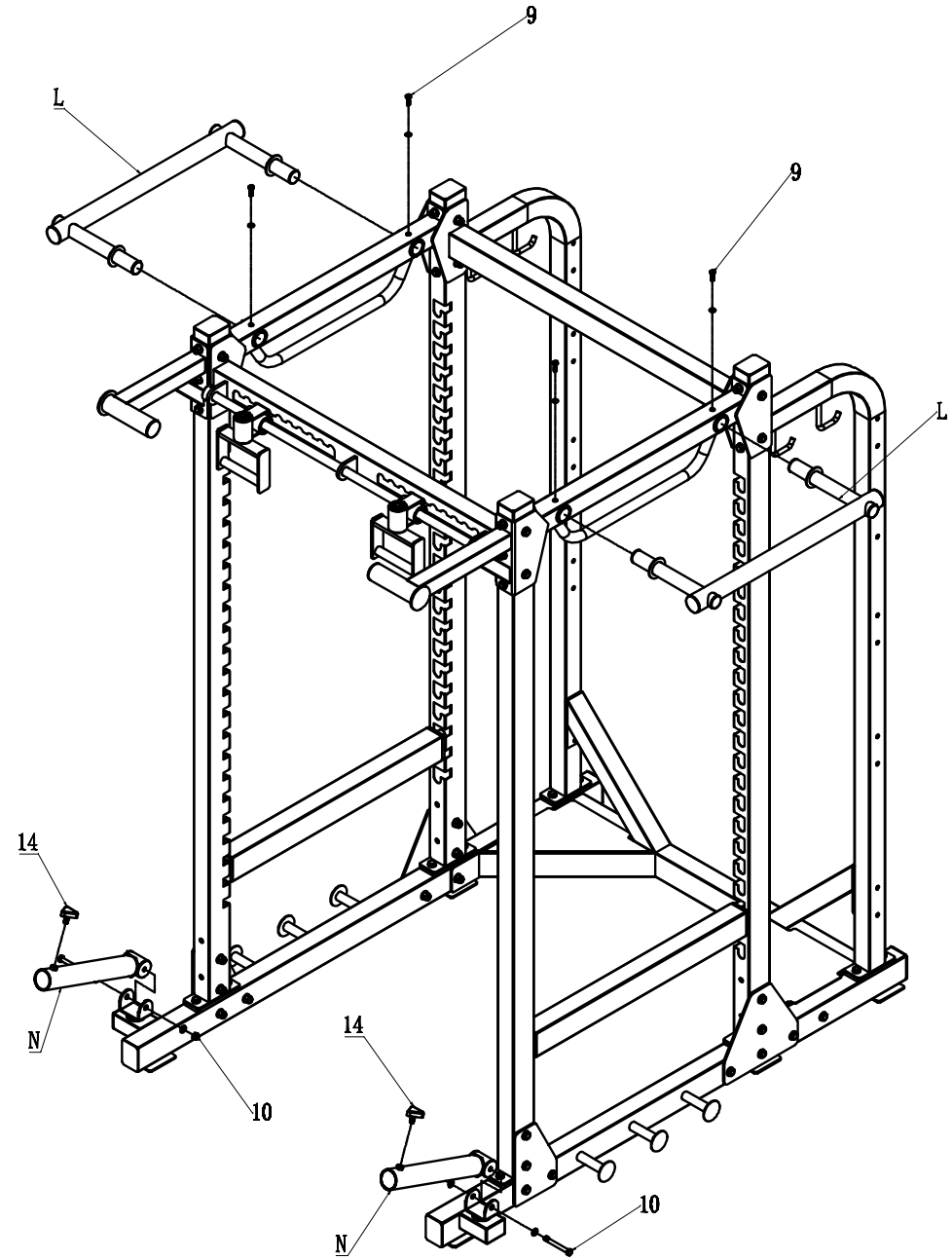

※ there is anti-slip nylon damp please strenthen it in tool.

4

# The composing of accessories

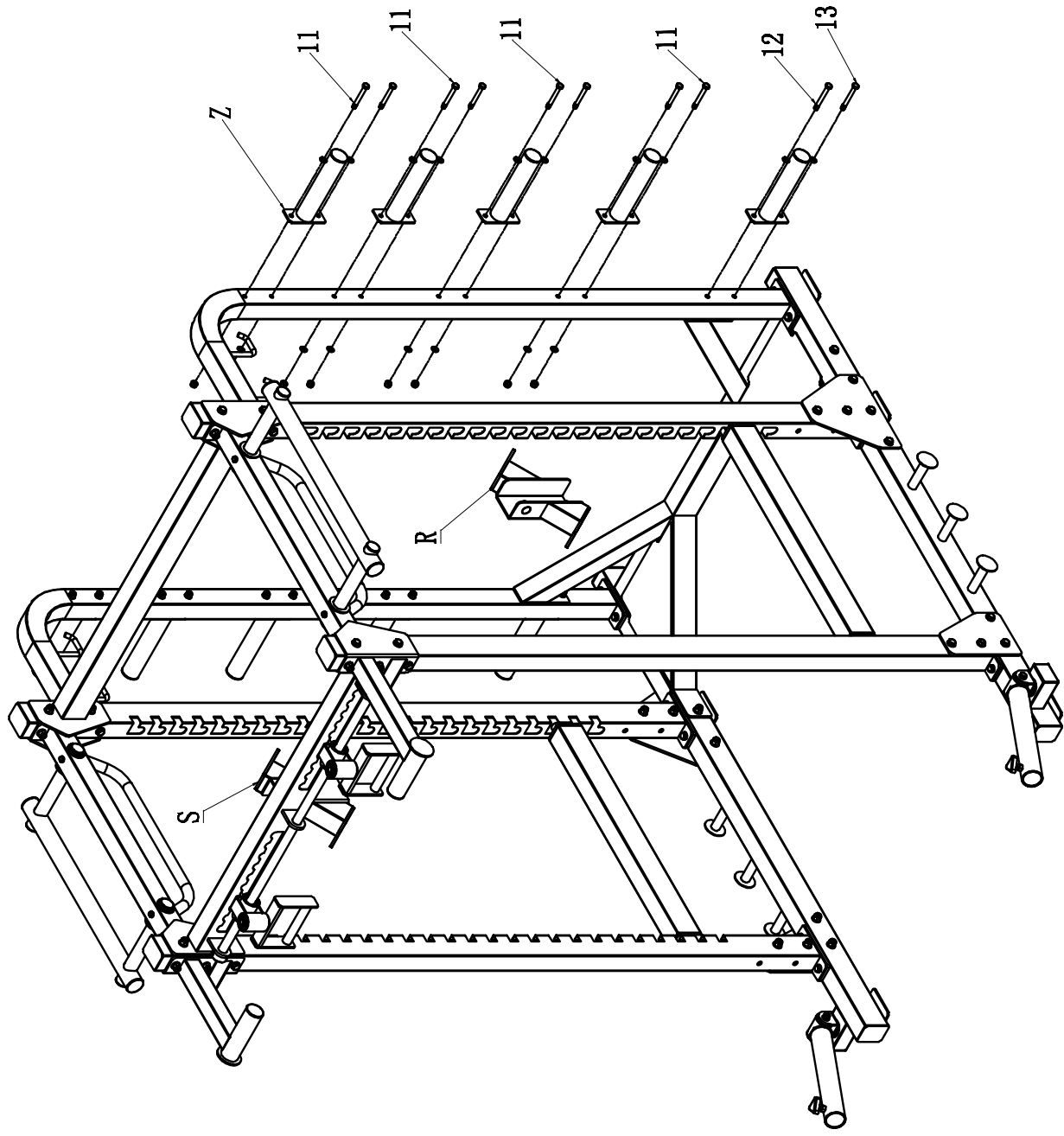

※ there is anti-slip nylon damp please strenthen it in tool.