



another kind of playground

- ⓁⓋ Montāžas instrukcija
- ⓔⓃ Installation manual
- ⓓⓔ Montageanleitung
- ⓔⓐ Manuale di installazione

Cienijamais pircēj! Paldies, ka iegādājāties mūsu produktu! Mēs ceram, ka tas radīs daudz prieka Jūsu bērniem un atpūtas brīžus Jums.

Uzmanību! Šis produkts ir paredzēts lietošanai tikai mājas vajadzībām āra apstākļos. Produkts paredzēts lietošanai bērniem vecumā no 5 līdz 12 gadiem.

Pirms produkta lietošanas lūdzam rūpīgi izlasīt šo lietošanas instrukciju. Lūdzu saglabāties šo instrukciju visu produkta lietošanas laiku. Ievērojiet visus instrukcijā minētos produkta montāžas un lietošanas norādījumus. Produkta montāža ir samērā vienkārša un neprasa kādas īpašas iemaņas, tāpēc domājam, ka to Jūs varat paveikt pats saviem spēkiem. Sekojiet produkta montāžas soliem un produkta montāžu veiciet tikai tādā secībā, kāda ir norādīta ilustrācijās. Pareiza produkta montāža ir ļoti svarīga produkta ilgai kalpošanai, kā arī Jūsu bērnu drošībai.

Pirms sāciet montāžu, vispirms izvēlaties vietu Jūsu pagalmā produkta montāžai. Vietai, kur plānojat novietot produktu jābūt līdzenai (*skatīt 1. zīmējumu*). Produkts Jūsu pagalmā aizņems aptuveni 4x4 metru lielu laukumu. Taču laukumam, kur novietosiet šo produktu būs nepieciešams apmēram 8x8 metru brīvs laukums. Produktu jānovieto vismaz 2 metru attālumā no citiem Jūsu pagalma objektiem, kā piemēram, mājas, garāžas, sētas, kokiem un to nokarenajiem zariem, veļas žāvēšanas auklām, piebraucamā ceļa vai elektroinijām (*skatīt 2. zīmējumu*). Lai novērstu slidkalniņa virsmas uzkaršanu, produktu novietojiet, lai slidkalniņa virsma nebūtu vērsta uz dienvidiem. Produkts ir paredzēts novietošanai uz miksta zemes seguma – piemējas zāliena. Produktu nedrīkst novietot uz cieta zemes seguma, kā piemēram, uz asfalta, betona, bruģa.

Produktu montāžai izmantojiet tikai komplektācijā ietilpstošo instrumentu. Papildus Jums būs nepieciešams tikai āmurs skrūvju dekoratīvo uzliku un enkuru montāžai, lāpsta un līmeņrādis produkta līmeņošanai. Skrūvju montāžai var izmantot elektrisko skrūvjgriezni, taču lai izvairītos no skrūvju pārvilkšanas un skrūvju dekoratīvo uzliku bojājumiem, elektriskajam skrūvjgrieznim noregulējiet minimālo pievilkšanas spēku. Pēc tam katru skrūvi pārveiciet, izmantojot komplektācijā ietilpstošo T-veida atslēgu.

Kad produkts ir samontēts un novietots tam paredzētajā vietā, pārbaudiet, vai stāv taisni. Pārbaudei variet izmantot līmeņrādi, novietojot to uz platformas dažādos virzienos. Ja produkts nav taisns, lietojiet lāpstu un izņemiet zemi zem produkta kājas, kas atrodas visaugstāk. Ja nepieciešams, atkārtojiet darbību, līdz produkts stāv taisni (*skatīt 3. zīmējumu*) un 8. soli.

Ja vēlaties produktu papildināt ar aksesuāriem, tad izmantojiet tikai oriģinālos ražotāja aksesuārus. Aksesuāru montāžu pie produkta veiciet, vadoties pēc tiem pievienotās montāžas instrukcijas.

Reizi trīs mēnešos apsekojiet produktu, vai tam nav radušies kādi bojājumi. Īpašu vērību pievēršiet plastmasas detaļām, slidkalniņa virsmai un šūpoļu stiprinājumiem, vai tiem nav radušies tādi bojājumi, kā plaisas, nelīdzenumi, asumi, kā arī, vai to stiprinājumi ir kārtīgi nostiprināti.

Reizi gadā, uzsākot sezonu, veiciet rūpīgu produkta apsekošanu, pārbaudot, vai visas detaļas ir kārtīgi nostiprinātas, stiprinājumu skrūves pievilktas un skrūvju dekoratīvās uzlikas ir veselas. Skrūves, kas apslēptas zem dekoratīvajām uzlikām varat pārbaudīt tās ar roku pakustinot. Ja uzlika kustās, pasūtiet pie mums jaunu uzliku, izskrūvējiet skrūvi, apmainiet veco uzliku pret jauno un pievelciet skrūvi. Veiciet rūpīgu karkasa detaļu pārbaudi, vai plastmasas savienojumos un koka brusās nav parādījušās plaisas, kas varētu ietekmēt konstrukcijas stiprību. Ja nepieciešams, atjaunojiet koka detaļu krāsojumu, krāsas vai krāsas toņus variet iegūt, sazinoties ar mums. Veiciet šūpoļu krēsla augstuma pārbaudi, nepieciešamības gadījumā to noregulējiet, vadoties pēc montāžas instrukcijas.

Ja ir kādas neskaidrības vai jautājumi, sazinieties ar produkta izplatītāju vai ražotāju.

Pieļaujami sveķu notecējumi no koka brusām, kurus lūdzam notīrīt ar atbilstošu tīrīšanas līdzekli.

Jūsu iegādātā modeļa krāsas var atšķirties no ilustrācijās attēlotajām.

Dear buyers! Thank you for purchasing our products! We hope that this will cause a lot of fun for your children and the rest of you.

Attention! This product is intended for family domestic use only on the needs of outdoor conditions. The product is intended for children aged from 5 to 12 years.

Before the use of the product, please carefully read these instructions for use. Please save these instructions for use of the product all the time. Obey all instructions of the products referred to in the storyboard and use instructions. Product Assembly is relatively simple and does not require any special skills, so you think you can do the same. Follow the steps in the Assembly of the product and product Assembly is carried out only in the order that is specified in the figures. Correct Assembly of the product is very important to the long lifetime of the product, as well as your children's safety.

Before you start editing, you must first choose the location of your yard for the Assembly of the product. The location where you plan to place the product must be level (*see 1 Drawing*). Product your yard will take approximately 4 meters high. However, you will use this product you will need approximately 8 x 8 metre area. The product must be placed at least 2 metres from other your yard objects, such as home, garage, fences, trees and the overhanging branches, laundry lines, driveway or lines (*see 2 Drawing*). To prevent the heating of the surface of the slide, position the product to the surface of the slide should not be directed to the South. The product is intended for placement on the soft ground coverage – backyard lawn. Products may not be placed on the hard ground cover, such as on the asphalt, concrete, pavement.

The Assembly of the product, use only the supplied tools. In addition, you will only need a hammer screw ornamental lining and anchor Assembly, shovels and levelling of the product level. Bolt Assembly can use electrical screwdriver, but in order to avoid sliding bolt and bolt ornamental lining damage, electric screwdriver to adjust the minimum force of gravity. After each bolt drag using the supplied T-shaped key.

Once the product is assembled and placed it in the space provided, check, or stand straight (*see 3 Drawing*). Verifying can use provided by placing it on a platform in different directions. If the product is not straight, use a shovel and remove the ground beneath the feet of the product, which is highest. If necessary, repeat until the product is standing straight (see 8th step).

If you want to be added to the product with accessories, and then use only the original manufacturer's accessories. Accessories for the Assembly to make the product, according to the attached mounting instructions.

Every three months, inspect the product or not there are any defects. Special attention should be paid to the plastic parts, the surface of the slide and swings fastenings, or have not incurred such as cracks, uneven, sharpness, as well as, or their anchorages are secure.

Once a year, at the start of the season, make a thorough survey of the product, making sure all parts are securely fastened, fastening screws and bolts tightened ornamental linings are intact. Screws that hidden below the ornamental faces you can check it with the hand moving. If you put in order the moving to a new place, remove screws, replace the old with the new lining and tighten the screw. Do a thorough examination of the parts of the body, or plastic compounds and wooden beams are not shown in the cracks, which could affect the design strength. If necessary, restore the wooden parts painted, color, or color shades you can obtain by contacting us. Do the swing chair height check, if necessary, adjust it according to the Assembly instructions.

If there is any confusion or question, contact your dealer or manufacturer.

The resin may occur on the wooden beams and should be cleaned with a suitable cleaning agent.

Colours of Your model may differ from the illustrations.

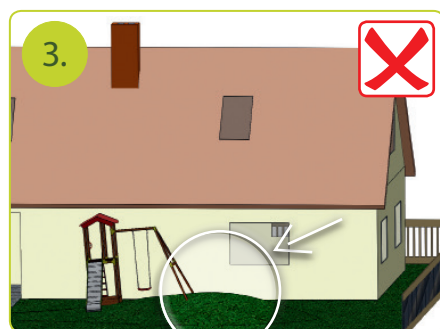
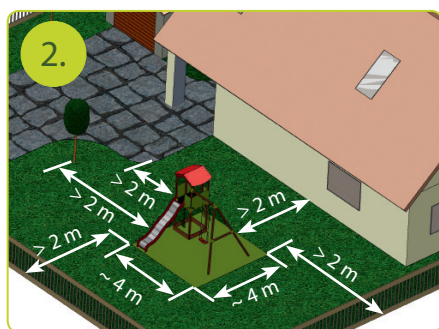
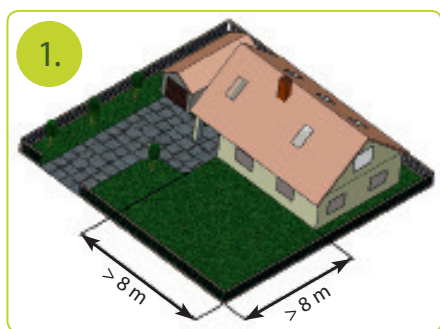

Gentile cliente! Grazie per aver scelto il nostro prodotto! Speriamo di dare molto divertimento ai vostri bambini e uno svago per voi.

Attenzione! Questo prodotto è destinato esclusivamente a un uso domestico all'aperto. Il prodotto è destinato ai bambini da 5 a 12 anni.

Si prega di leggere attentamente queste istruzioni per familiarizzarsi con il prodotto prima di utilizzarlo. Conservare questa documentazione a portata di mano in modo da poterla consultare quando necessario. Seguire tutte le istruzioni per l'assemblaggio del prodotto e le istruzioni per l'uso. L'assemblaggio del prodotto è relativamente semplice e non richiede particolari abilità, per questo pensiamo che sia possibile realizzarlo da soli. Eseguite solo gli interventi di manutenzione e riparazione descritti nella documentazione. Seguite esattamente i passaggi previsti. L'installazione corretta del prodotto è molto importante per una lunga durata e per la sicurezza del vostro bambino. Prima di iniziare l'installazione, è necessario innanzitutto scegliere una posizione nel vostro giardino per l'installazione del prodotto. Il posto dove si prevede di collocarlo deve essere pianeggiante (vedi l'immagine no.1). Il prodotto nel vostro giardino coprirà un'area di circa 4x4 metri. Mentre lo spazio totale necessario e disponibile per questo prodotto sarà di circa 8x8 metri. Il prodotto deve essere posizionato ad almeno 2 metri di distanza dagli altri oggetti nel vostro giardino, per esempio case, garage, recinti, alberi e rami pendenti, linee di lavanderia, strada di accesso o linee elettriche (vedi l'immagine no.2). Per evitare il riscaldamento della superficie dello scivolo, posizionate il prodotto in modo che la superficie dello scivolo non sia rivolta a sud. Il prodotto è progettato per essere posizionato su un terreno morbido sul prato vicino a casa.

Il prodotto non deve essere posizionato su terreno duro, per esempio asfalto, cemento o pavimentazione. Per l'assemblaggio del prodotto dovete utilizzare solo gli strumenti inclusi. Inoltre avrete solo bisogno di un martello per assemblare le coperture decorative delle viti e gli ancoraggi, di una vanga e di una livella per il livellamento del prodotto. Si può utilizzare un avvitatore elettrico per l'assemblaggio delle viti, ma per evitare di danneggiare le coperture decorative delle viti, regolate al minimo l'avvitatore elettrico. Poi avvitate ciascuna vite, utilizzando la chiave in dotazione a forma di T.

Una volta che il prodotto è stato assemblato e posizionato controllate se è dritto. Per il controllo potete utilizzare una livella, posizionandola sulla piattaforma in diverse direzioni. Se il prodotto non è dritto, utilizzate una vanga per togliere la terra sotto la colonna del prodotto che resta più alta. Se necessario ripetete questa operazione, fino a quando il prodotto è in posizione perfettamente verticale (vedi l'immagine no.3), vedi il poco 8.

Se desiderate aggiungere degli accessori al prodotto, utilizzate solo gli accessori originali del produttore.

L'assemblaggio degli accessori si deve fare seguendo le istruzioni allegate.

Ogni tre mesi controllate se il prodotto presenta dei danni. Prestate particolare attenzione alle parti plastiche, alla superficie dello scivolo e ai fissaggi della dondola. Controllate se non presentano danni, come crepe od ondulazioni e se gli elementi di fissaggio siano ben fissati.

Una volta all'anno, all'inizio della stagione, fate un controllo completo del prodotto. Dovete verificare che tutte le parti siano ben fissate, le viti di fissaggio strette e le coperture decorative delle viti integre. Potete controllare le viti nascoste sotto le coperture decorative muovendole con la mano. Se la copertura si muove, allora ordinate una copertura nuova da noi produttori, svitatela, sostituite la copertura vecchia con la nuova e stringete la vite. Fate un controllo attento delle parti della struttura, se nelle giunture plastiche e nelle travi in legno non ci sono crepe che potrebbero influenzare la resistenza strutturale. Se necessario, restaurate la pittura delle parti in legno; contattateci per ottenere il colore o la tonalità giusta. Verificate l'altezza della sedia di dondola. Se necessario, potete regolarla seguendo le istruzioni allegate.

Se avete richieste o domande, contattate il distributore dei prodotti o il produttore.

La resina può verificarsi su travi in legno e deve essere pulita con un detergente adatto. I colori del vostro modello possono differire dalle illustrazioni.

Sehr geehrter Kunde! Vielen Dank, dass Sie sich für unser Produkt entschieden haben. Wir sind uns sicher, dass Ihre Kinder, Enkel oder deren Freunde viel Spaß damit haben werden.

Achtung! Das Produkt ist nur für den Außenbereich verwendbar und für Kinder im Alter von 5 bis 12 Jahre geeignet.

Vor der Benutzung lesen Sie bitte sorgfältig die Aufbauanleitung. Verwahren Sie die Aufbauanleitung an einem sicheren Ort. Folgen Sie beim Aufbau nur der Anleitung, denn nur der richtige Aufbau garantiert Ihnen und Ihrem Kind Sicherheit und lange Freude an unserem Produkt! Der Produktaufbau ist relativ einfach und erfordert ein geringes handwerkliches Geschick.

Bevor Sie nun mit dem Aufbau beginnen, sollten Sie den richtigen Standort für das Produkt wählen. Der Standort muss eben sein (siehe Bild 1), eine Verwendung am Hang ist nicht erlaubt. Die Fläche, die das Produkt beansprucht, entnehmen Sie bitte der Verpackung. Für den Aufbau benötigen Sie eine Fläche von ca. 8x8 Meter. Das Produkt muss mindestens 2 Meter Abstand zu anderen Objekten, wie z.B. dem Haus, Garage, Zaun, Bäumen, Wäscheleinen, Wegen oder anderen störenden Gegenständen, haben (siehe Bild 2). Um die Oberfläche der Rutsche gegen Überhitzung zu schützen, empfehlen wir diese nicht in Südrichtung aufzubauen. Für einen sicheren Stand benötigt das Produkt einen weichen Untergrund (Sand oder Gras). Das Produkt darf nicht auf hartem Untergrund wie z.B. Asphalt, Beton, Pflaster etc. aufgestellt werden.

Für den Aufbau verwenden Sie bitte nur die mitgelieferten Werkzeuge. Zusätzlich benötigen Sie einen Hammer, Schaufel und Wasserwaage. Für die Bolzen können Sie unter Umständen zusätzlich einen Akkuschrauber verwenden, beachten Sie hierbei die Einstellung der Geschwindigkeit am Gerät und lesen Sie hierzu die Hinweise des Herstellers. Für die Schrauben verwenden Sie bitte nur den mitgelieferten Torx-Schlüssel.

Ist das Produkt gemäß Aufbauanleitung montiert und am richtigen Standort, überprüfen Sie bitte alle Teile auf festen Sitz und den korrekten Stand mit Hilfe der Wasserwaage. Sollte das Produkt nicht perfekt ausgerichtet sein, überprüfen Sie bitte den Boden auf Unebenheiten und entfernen ggf. mit der Schaufel diese (siehe Schritt 8).

Eine Erweiterung des Produkt ist ausschließlich mit Wendi Toys Zubehör möglich. Diese Garantiert eine korrekte Befestigung mit dem von Ihnen erworbenen Produkt.

Bitte überprüfen Sie das Produkt **alle 3 Monate auf festem Stand**. Beschädigungen und festen Sitz aller Schrauben. Besonderes Augenmerk gilt den Plastikverbindungen, der Oberfläche der Rutsche und den Schaukelhalterungen. Bei der Überprüfung sollten keine scharfen Kanten, Risse, und Unebenheiten vorhanden sein. Überprüfen Sie bitte auch die Bodenverankerung auf festen Sitz.

Einmal im Jahr muss das Produkt komplett überprüft werden. Das können Sie selber machen, in dem Sie mit Hilfe dieser Aufbauanleitung jeden Montageschritt visuell einmal wiederholen. Beachten Sie dabei besonders den Sitz der Schrauben! Holz- und Plastikteile sollten keine Risse aufweisen.

Streichen Sie falls notwendig alle Holzteile. Schaukel und Rutsche überprüfen Sie wie bereits im Punkt zuvor benannt. Durch rütteln des Produkt mit der Hand können Sie den Stand kontrollieren und müssen diesen ggf. wie zuvor beschrieben verbessern.

Um das Produkt abbauen zu können, verwenden Sie diese Aufbauanleitung in umgekehrter Reihenfolge.

Für Fragen wenden Sie sich bitte an Ihren Händler oder an den Hersteller.

Harzrückstände am Holz bitte nur mit entsprechenden Reinigungsmitteln entfernen.

Farbabweichungen zwischen Bild und Original können vorkommen.

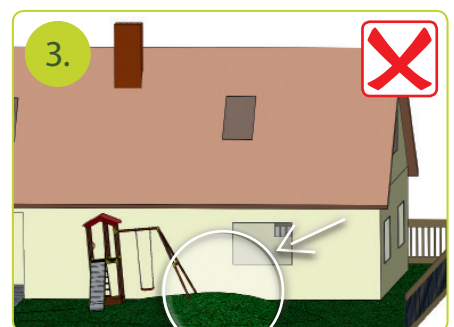
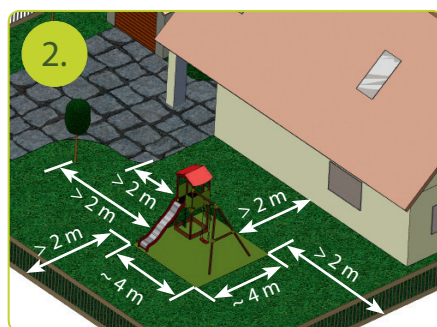
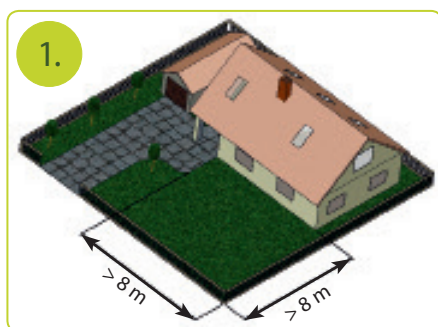

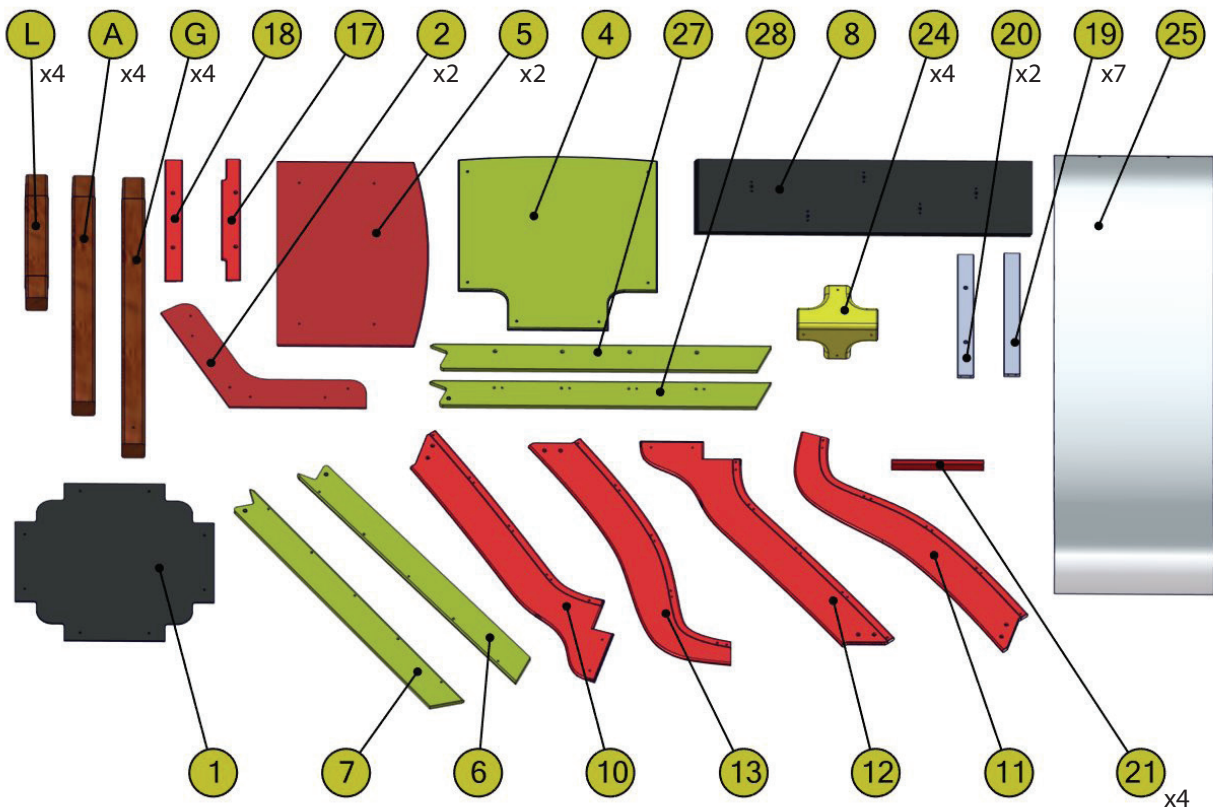
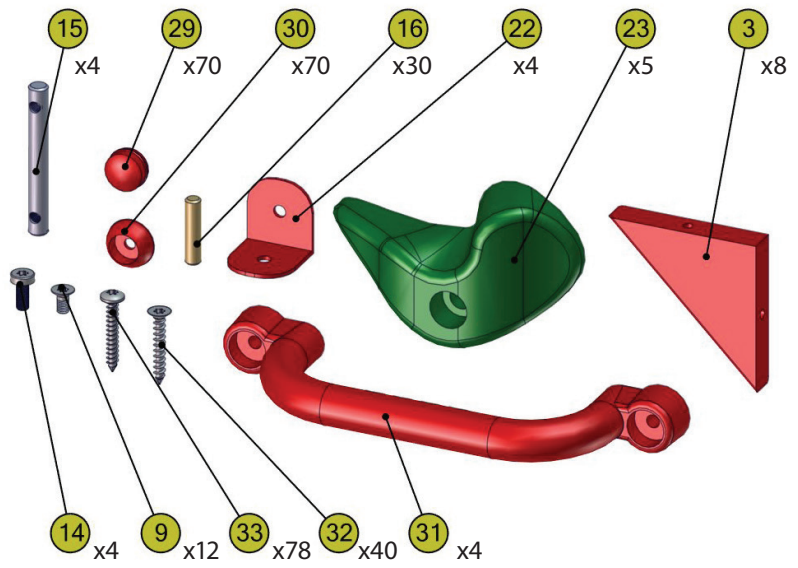
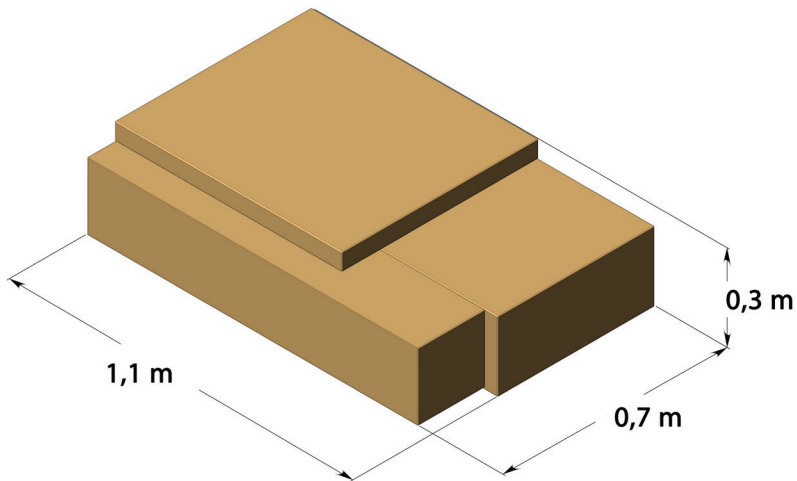



+

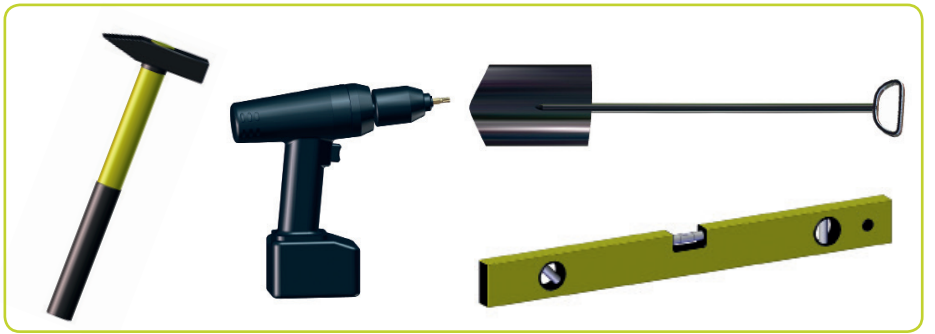

1.

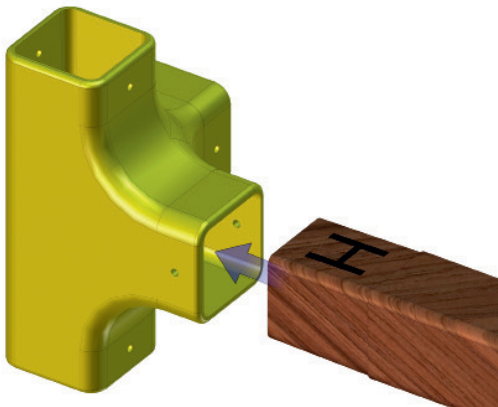

2.

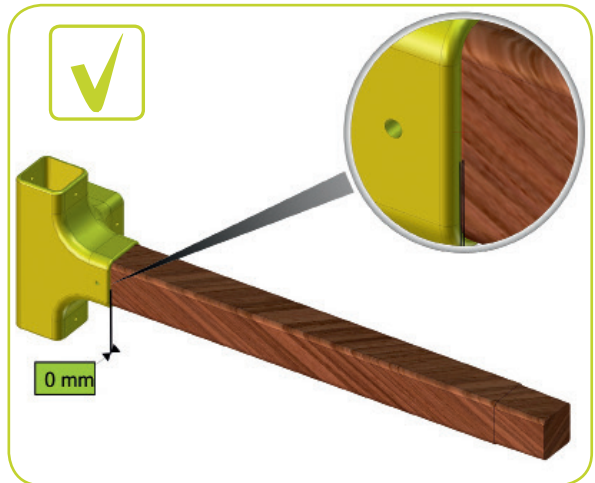
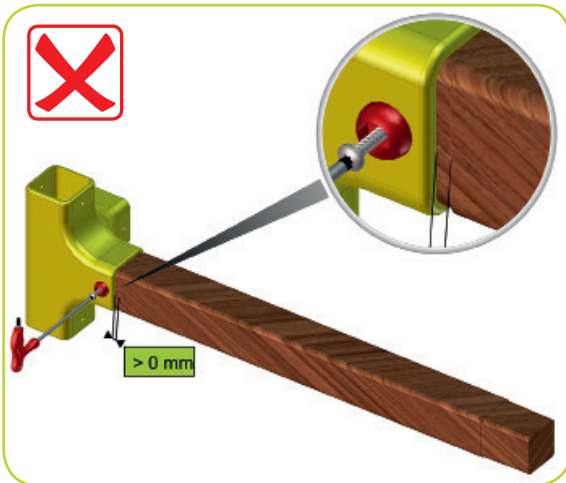
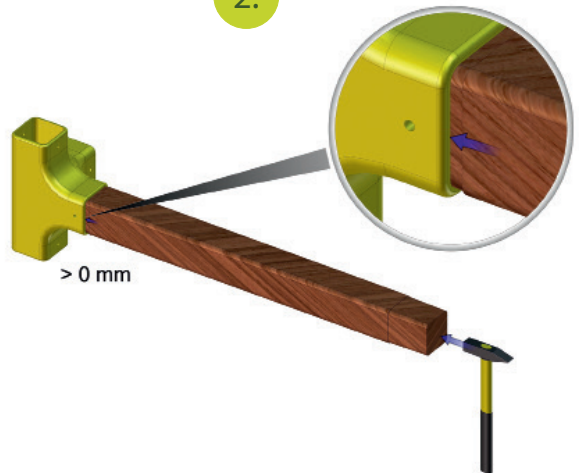

3.

a

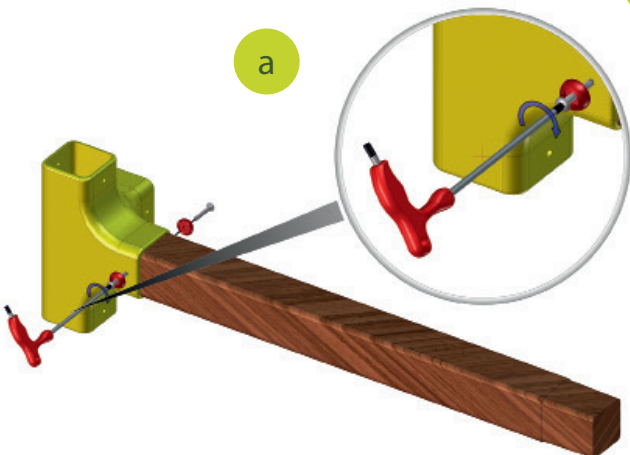

b

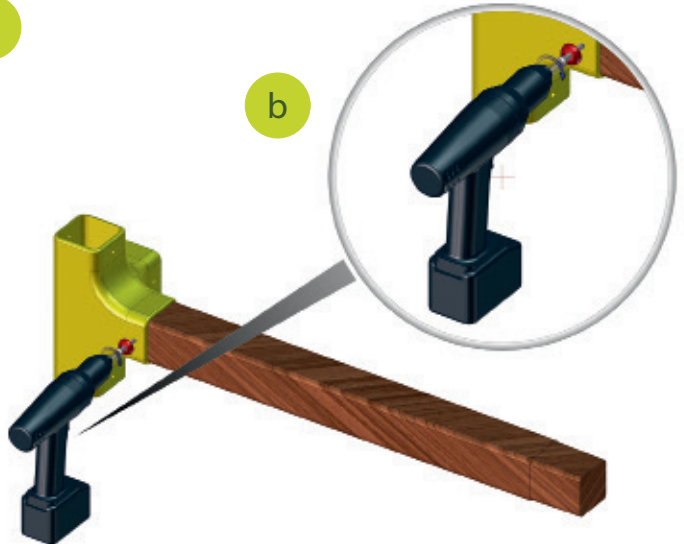

1.

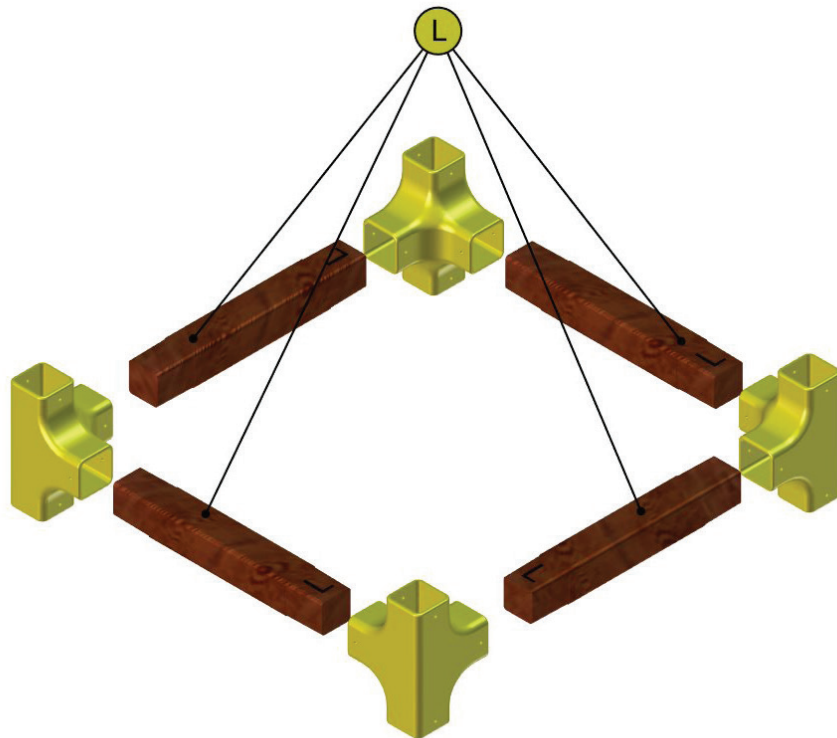
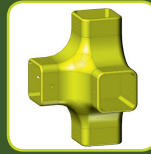

2.

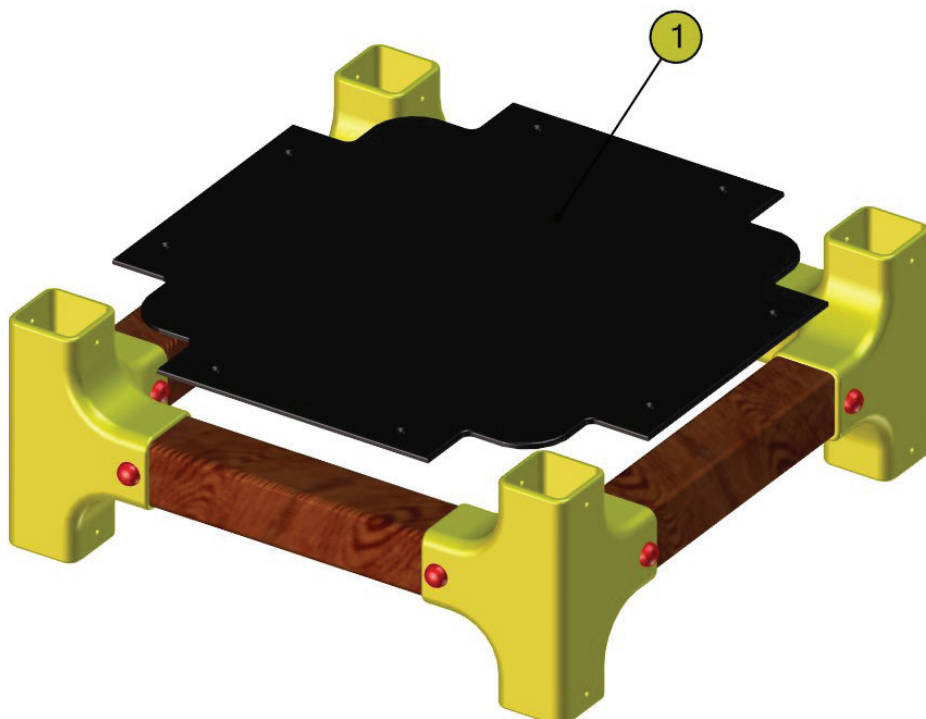

3.

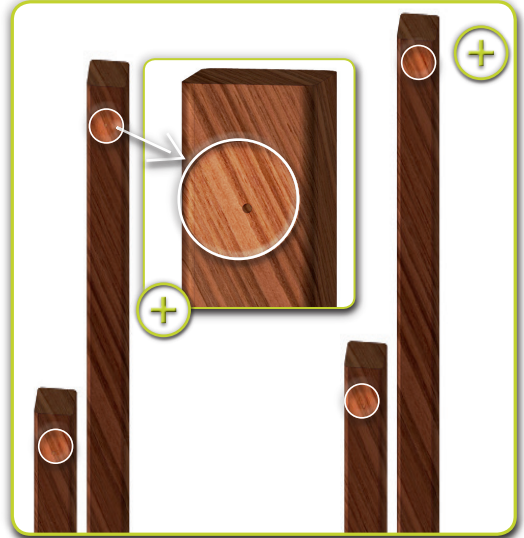
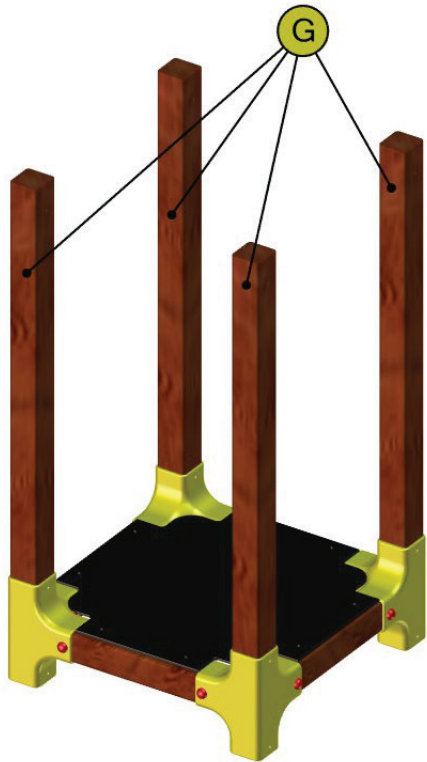

4.

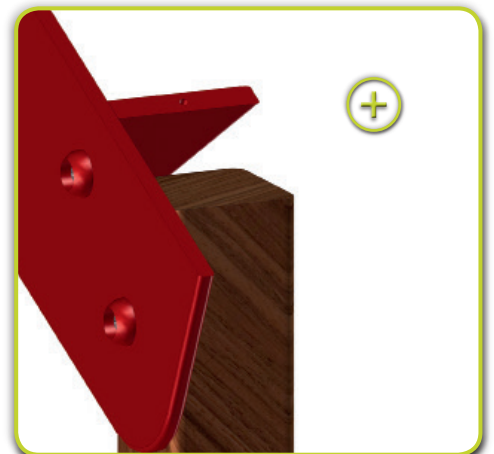
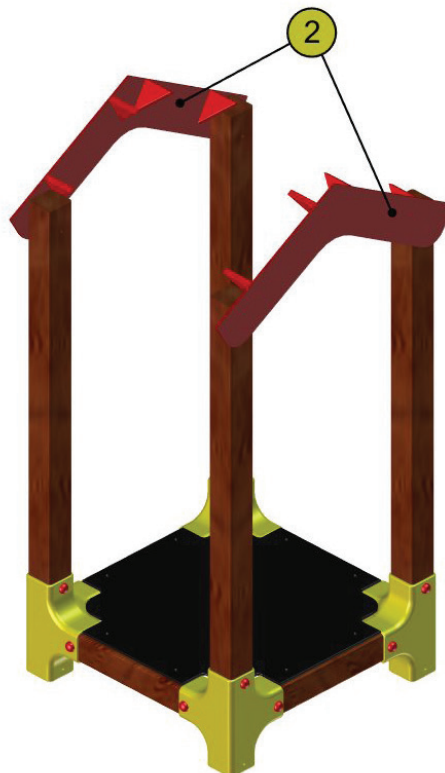
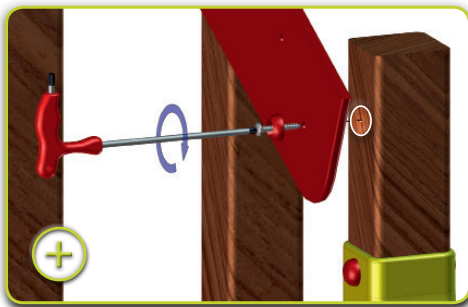

5.

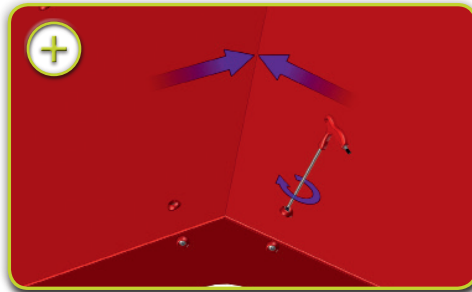

6.

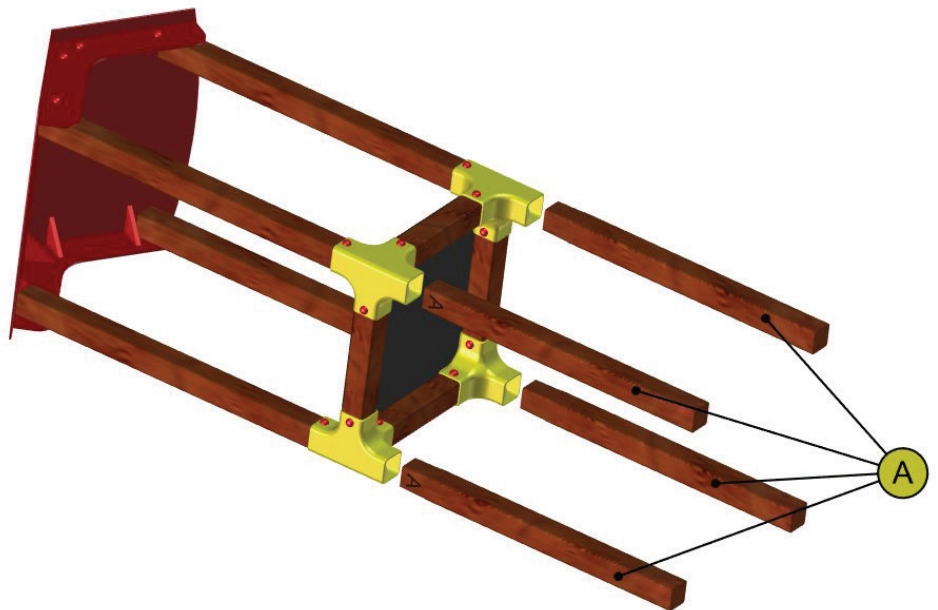
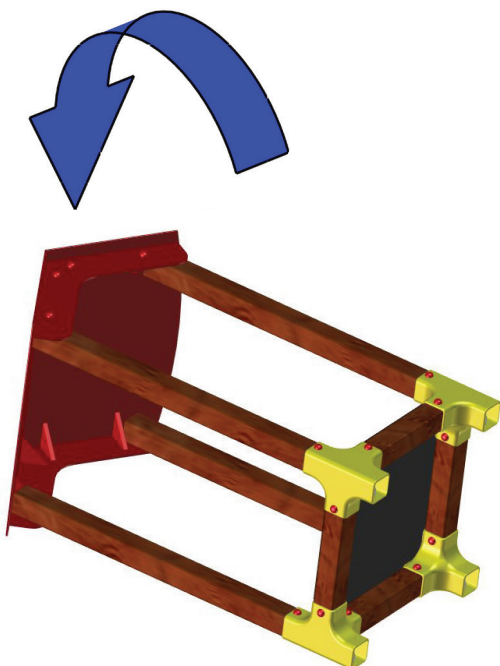

7.

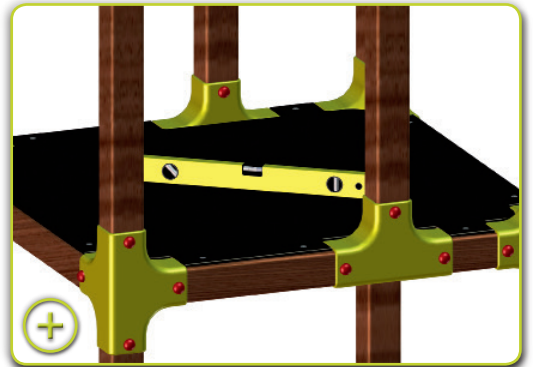
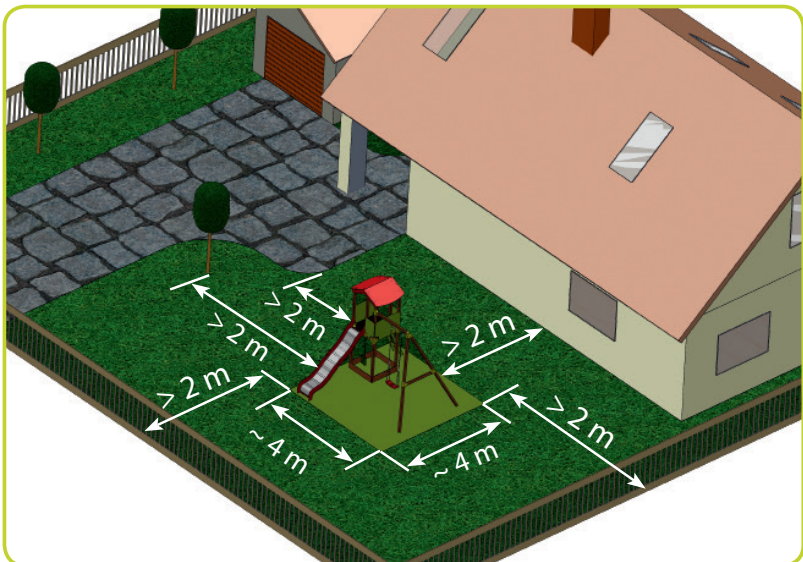
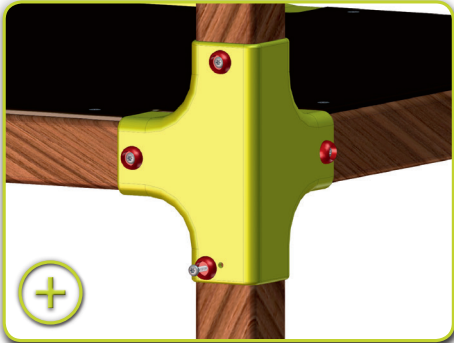
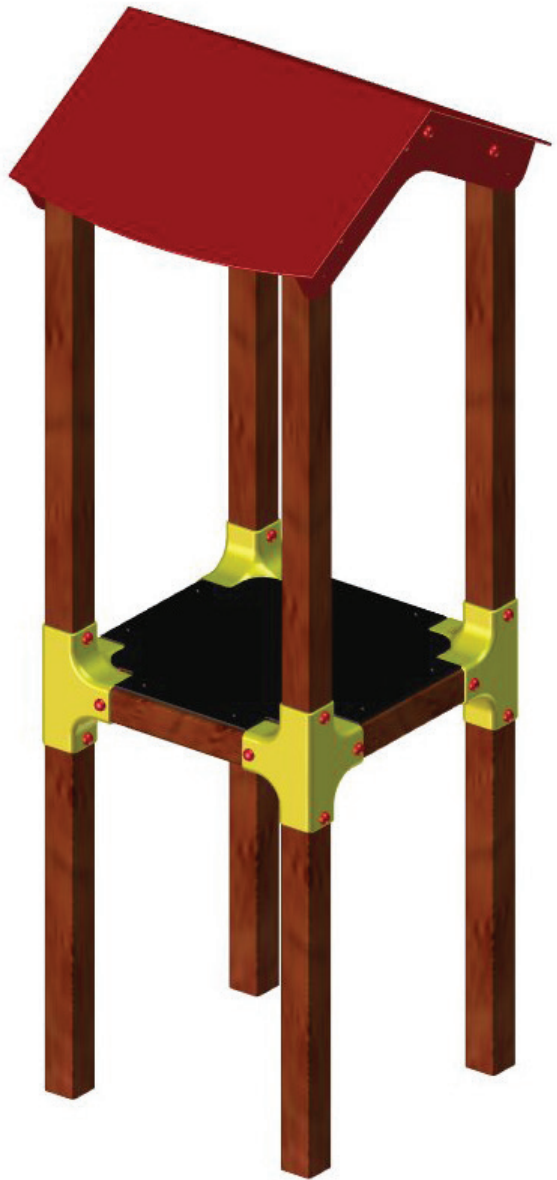
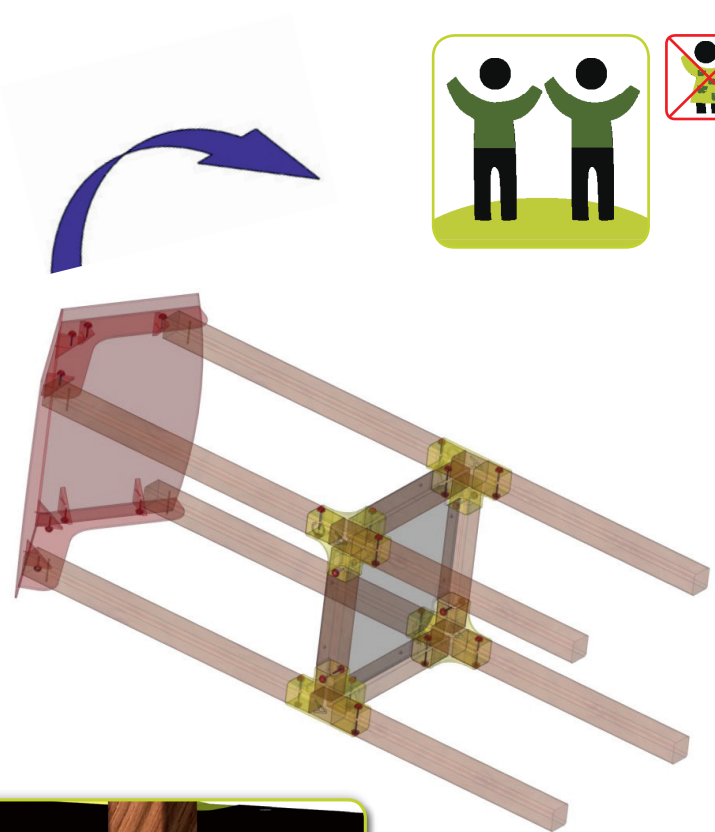
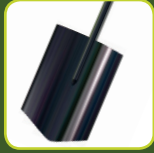

8.

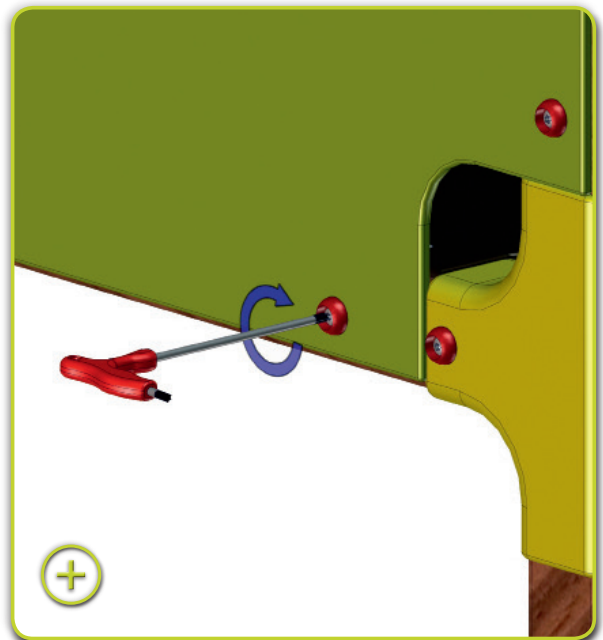
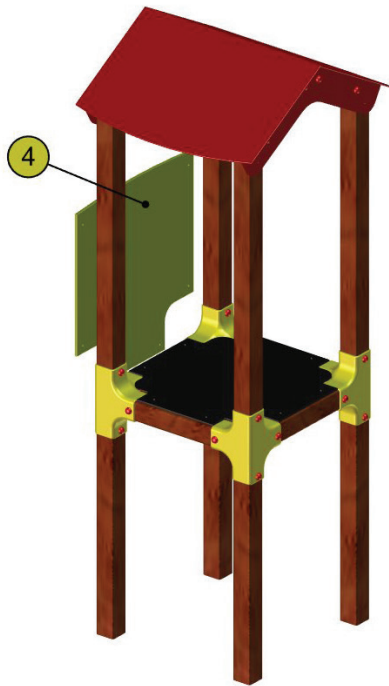

9.

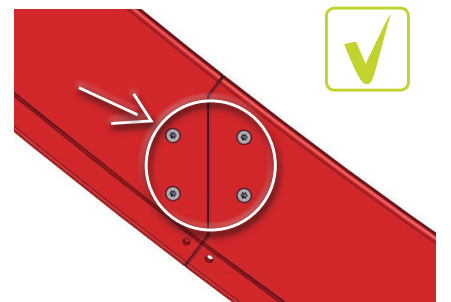
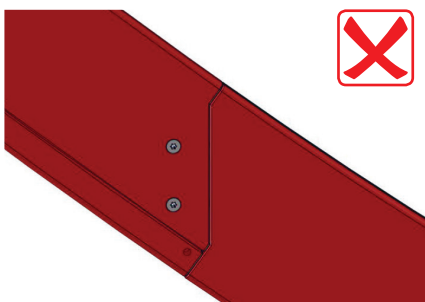
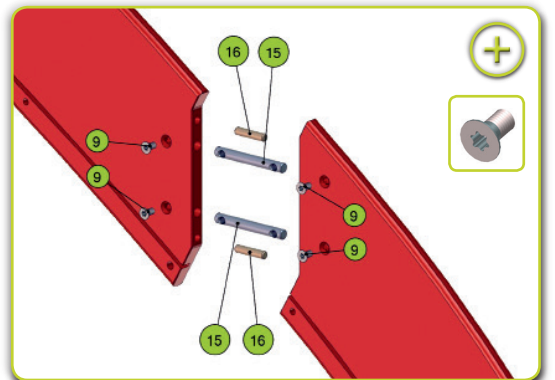
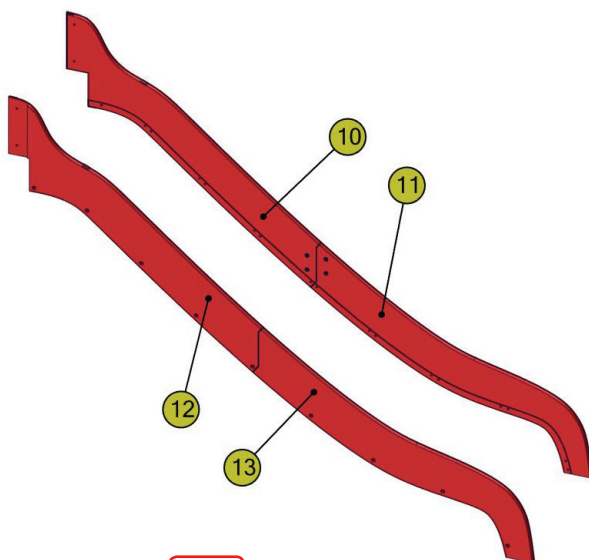

10.

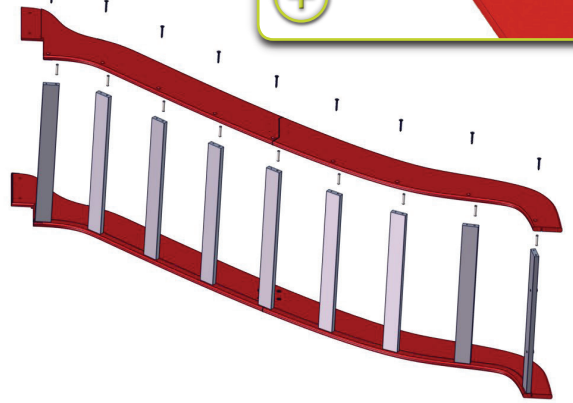
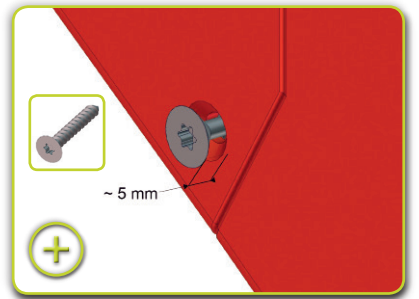
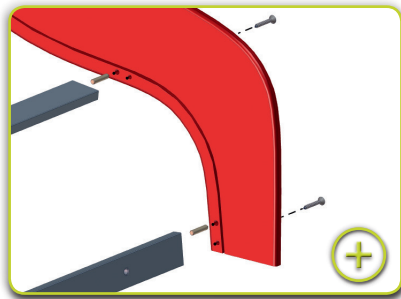
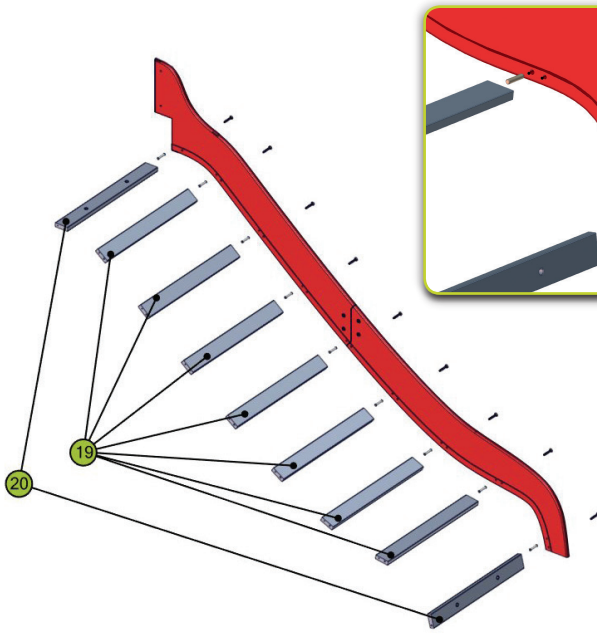

11.

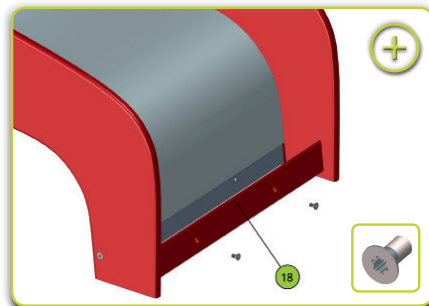
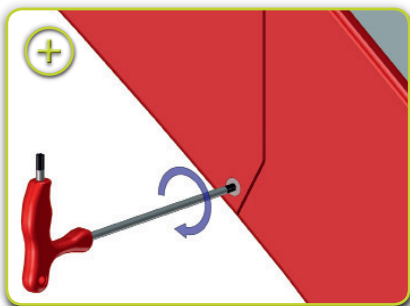
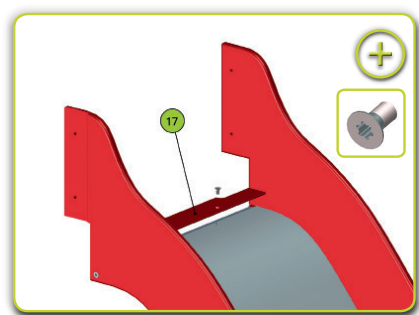
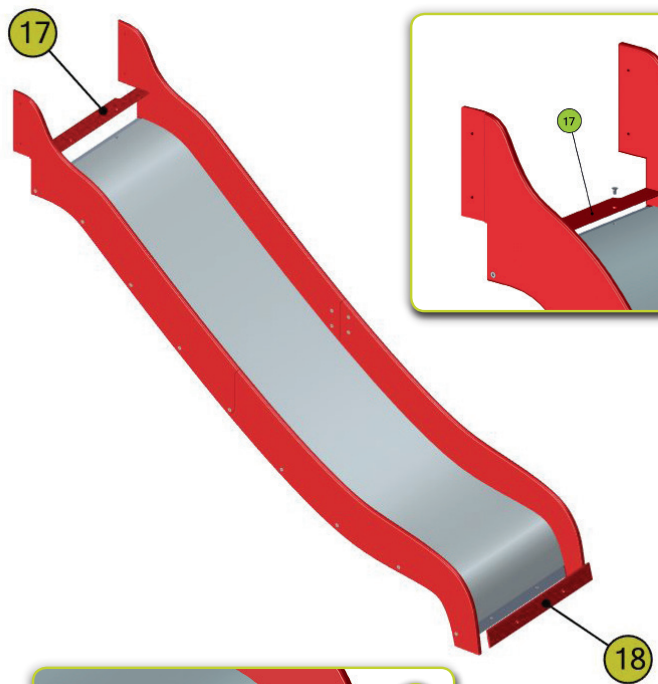
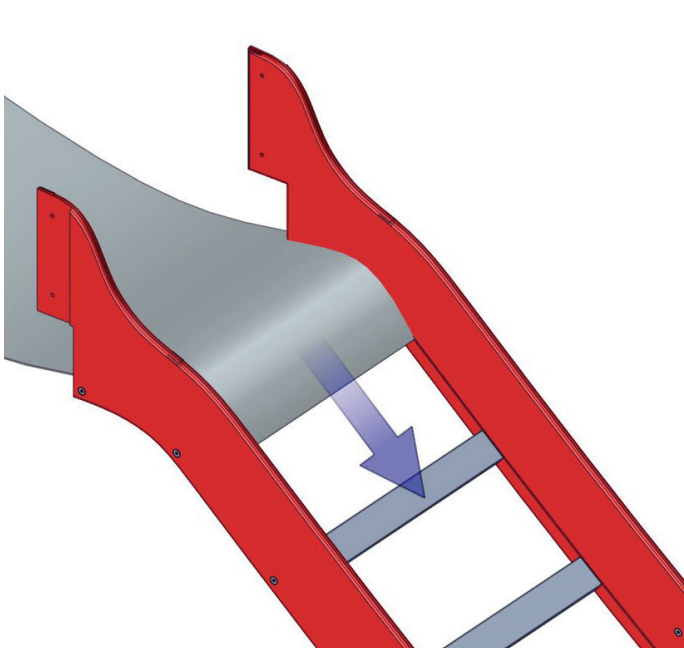

12.

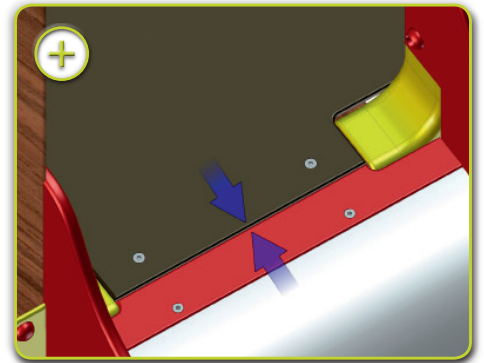
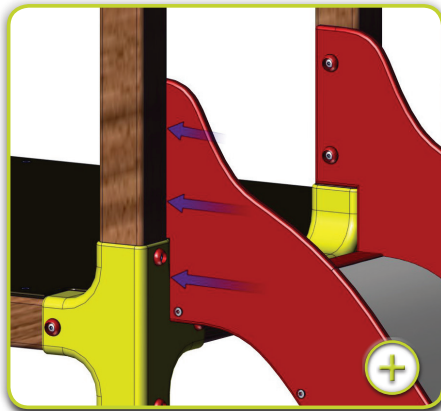

13.

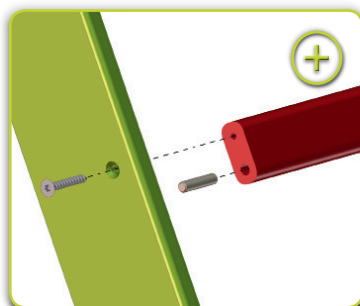
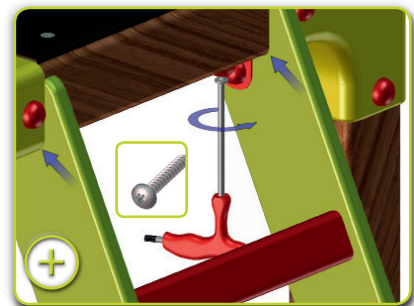
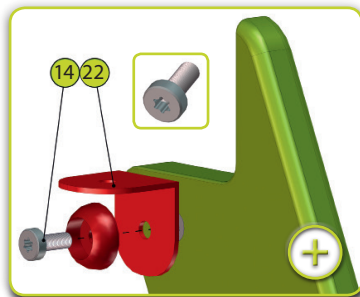
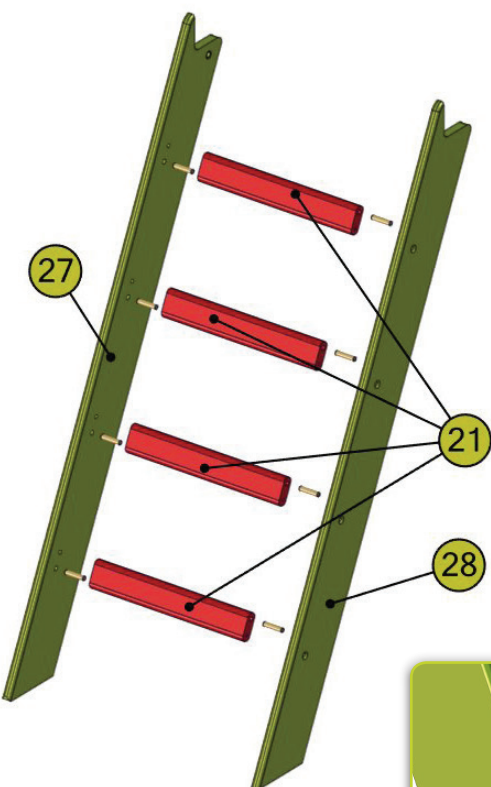
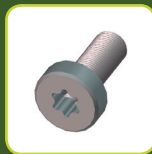

14.

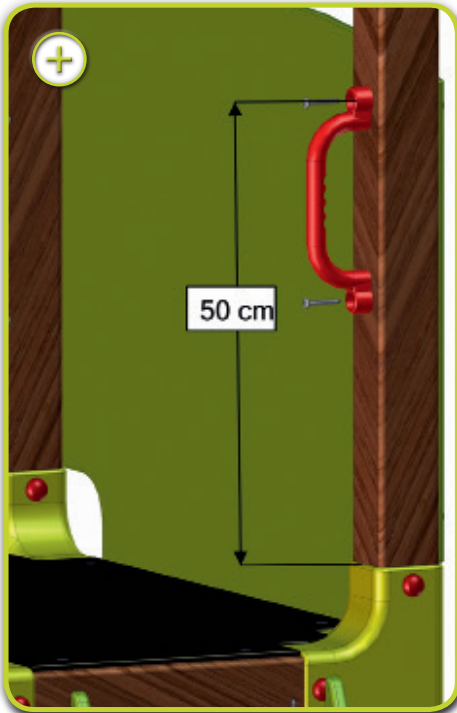

15.

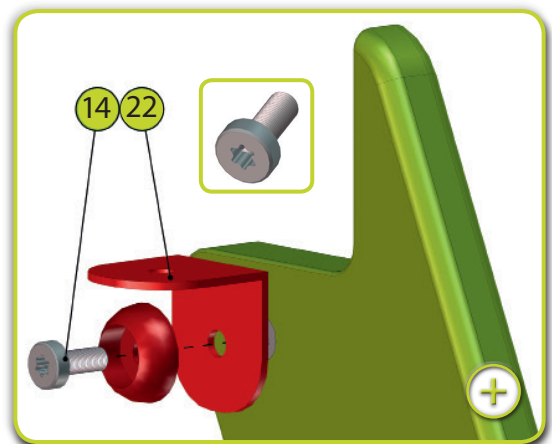
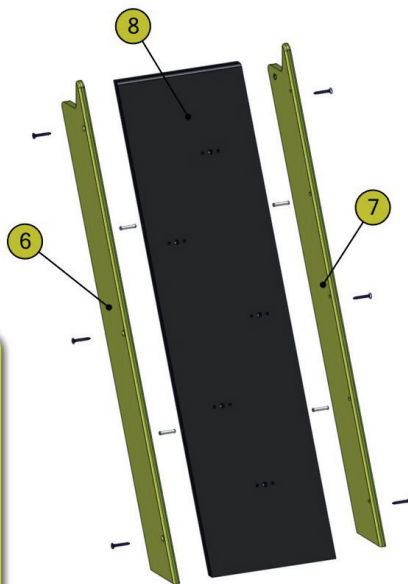
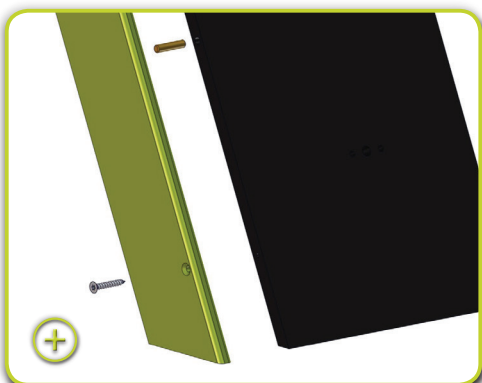
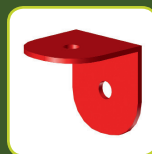

16.

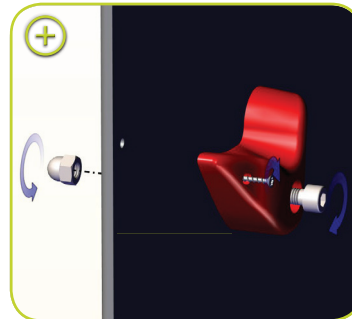
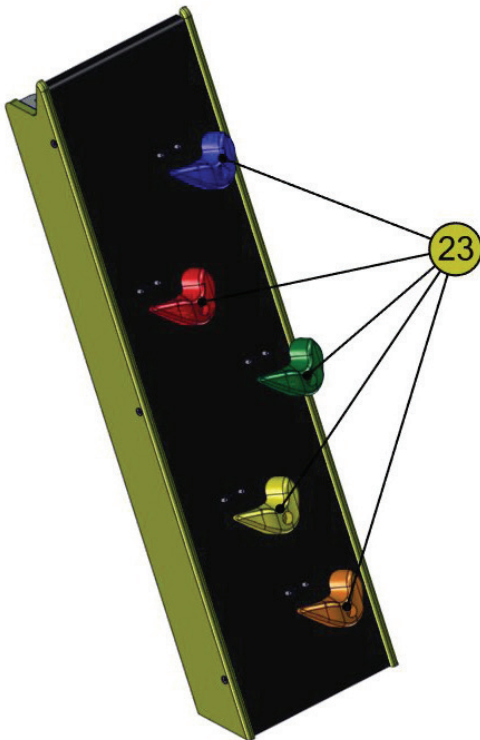

17.

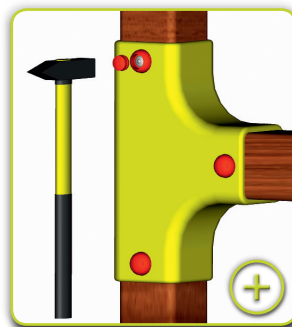

Wendi Toys Ltd

Gaujas 16/18, Cesis, LV-4101, Latvia
 +371 26 679 679
 info@wendi-toys.com
 www.wendi-toys.com

Produced under License.

Progear China Co Ltd

Suite I, 7th Floor, Chamber of Commerce Building, 13
 Bieye Road, Gongming Town, Shenzhen 518106, China
 +86 755 2742 4110



(LV)

Uzmanību! Satur mazas detaļas, nav piemērots bērniem līdz 3 gadiem! Garš striķis, Nožņaugšanās risks.

(EN)

Attention! Contains small parts. Not suitable for children under 3 years. Long cord. Strangulation hazard.

(DE)

Achtung! Nur für den Hausgebrauch. Speziell für den Außenbereich gedacht. Nicht für Kinder unter 36 Monaten geeignet. Kann kleine Teile enthalten. Lange Schnur. Strangulationsgefahr.

(IT)

Внимание! Не подходит для детей в возрасте до 36 месяцев! Содержит мелкие детали, длинные шнуры.

Attenzione! Non è adatto per un bambino di età inferiore ai 36 mesi. Può contenere piccole parti.

