



HYPERJUMP PLUS SPRING TRAMPOLINE OWNER'S MANUAL



WARNING!

The disassembled trampoline contains small parts which pose a choking hazard to children under 3.

IMPORTANT:

The owner's manual contains safety, assembly, use and maintenance instructions. The product must be assembled by an adult who has read and understood these instructions. Keep the packaging away from children and dispose of all packaging before use.

For the installer and your children's safety, it is important to fully read and understand the instructions and safety hazards before commencing the assembly of the product.



TABLE OF CONTENTS

1.	GENERAL SAFETY INSTRUCTIONS	4
1.1.	PURPOSE	4
1.2.	DANGER FOR CHILDREN	4
1.3.	RISK OF INJURIES	4
1.4.	PRODUCT DAMAGE	5
1.5.	ASSEMBLY ADVICE	5
2.	SAFETY INSTRUCTIONS	7
2.1.	ACCIDENT CATEGORIES	9
3.	ASSEMBLY INSTRUCTIONS	11
3.1.	PARTS	12
3.2.	FRAME ASSEMBLY	13
3.3.	MAT ASSEMBLY	15
3.4.	FRAME PADDING ASSEMBLY	16
3.5.	UPRIGHT POLE ASSEMBLY	17
3.6.	SAFETY NET ASSEMBLY	17
3.7.	NET ATTACHMENT	18
3.8.	LADDER ASSEMBLY	19

4.	SAFETY NET PRECAUTIONS	<u>20</u>
5.	MAINTENANCE	<u>21</u>
6.	CLEANING	<u>22</u>
7.	EXERCISE DIAGRAMS	<u>23</u>
8.	WARRANTY	<u>25</u>

1 GENERAL SAFETY INSTRUCTIONS

1.1 PURPOSE

This product is intended for indoor and outdoor, home, domestic use only. It is not suitable for commercial or medical use.

Do not exceed the weight limit of the trampoline

Size	8ft	10ft	16ft
Weight Limit	100kg	110kg	140kg

1.2 DANGER FOR CHILDREN

- **WARNING! Trampolines over 51cm (20 inches) in height are not recommended for children under six years of age.**
- **WARNING! No eating while jumping**
- Children do not recognize potential dangers from this product. The product must be stored out of reach of children and pets.
- This product may only be used with adult supervision at all times.
- The packaging material is not suitable for children due to choking and suffocation hazards.

1.3 RISK OF INJURIES

- Do not use the product if it is damaged or defective. If it is damaged or defective, please contact a qualified technician.
- Check the product before each use. Defective parts must be changed immediately as they can impair the function and the safety of the product.
- No more than one person to use the product at the same time.
- Use the product only on even and non-slip surfaces. Never use it near water and keep sufficient space around for safety.

- Beware of moving parts such as the springs or elastics, which could catch arms and legs. Do not place any objects or body parts in the product's openings.

1.4 PRODUCT DAMAGE



- Do not make alterations to the product. Only use original spare parts. Only qualified technicians should carry out repairs – improper repairs can lead to danger for the user. Use this product only as described in this manual.
- Protect the product against splashes, humidity, high temperature and direct sunlight.

1.5 ASSEMBLY ADVICE

- The assembly of the product must be done carefully and by two able-bodied adults. If in any doubt, ask a technically qualified person.
- Before you start with the assembly, read the instructions carefully.
- Remove all packaging materials and lay down all parts on an open space. This gives you an overview and simplifies the assembly procedure.
- Check with the parts list that all parts are available. Dispose of the packaging material when the assembly is completed.
- Beware that when using tools or doing technical work, there is always a risk of injuries. Assemble the product with care.
- Create a danger free environment; for example, do not let tools lay around the workspace. Store the packaging material in a way that cannot cause any danger.
- After installing the product according to the instruction manual, ensure all screws, bolts and nuts are correctly installed and tightened and that all joints are secure.
- A free space of at least 9.5 m is necessary above the trampoline. Reasonable space must be kept between the trampoline and possible sources of danger, such as power lines, tree branches, Playing devices, Swimming pools and fences,
- The trampoline must be assembled correctly before use.

- Never set up the trampoline in heavy rain, wind or storm conditions, especially lightning conditions. It is recommended that the trampoline be taken apart and stored in bad weather.
- Place the trampoline on a level surface at least 2 m from any structure or obstruction such as a fence, garage, house, overhanging branches, laundry lines or electrical wires.
- Trampolines shall neither be installed over concrete, asphalt or any other hard surface nor at proximity of other conflicting installations (e.g. paddling pools, swings, slides, climbing frames).
- Modifications made to the original trampoline (e.g. the adding of an accessory) shall be carried out according to the instructions of the manufacturer.
- The metal frame of the trampoline will conduct electricity. Lightning, extension cords and all electrical equipment must never be allowed to come in contact with the trampoline.
- The trampoline must always be used in a well-lit area.
- Do not place anything under the trampoline.
- Use gloves during assembly and disassembly
- Outdoor trampolines should be equipped with a device that in strong wind conditions avoid displacement due to wind (e.g. steel bars in the ground or loads like sand bag or water bags) and/or items catching wind like net and mat should be removed.
- In certain areas during winter, snow buildup and the low temperatures can damage the trampoline. It is recommended to remove snow buildup and to store the mat and the enclosure indoor.
- Replace the enclosure after 2 years of usage. This time indication is highly effected by weather conditions and the amount of UV exposure the trampoline is subject to. We strongly recommend visual inspections every 3 months to insure the integrity of the entire trampoline. Replace any parts as necessary.

2 SAFETY INSTRUCTIONS

WARNING			
 <p>Do not land on the head or neck. There is the danger of paralysis or death, even if landing in the center of the trampoline.</p> <p>No somersaults should be attempted, in order to avoid danger of a head or neck landing.</p>			<p>One person only at a time may use the trampoline. All children must be supervised while using the trampoline.</p> <p>Several persons jumping at the same time on the trampoline will increase the danger of control loss, collision or falls. This can lead to serious injury.</p>

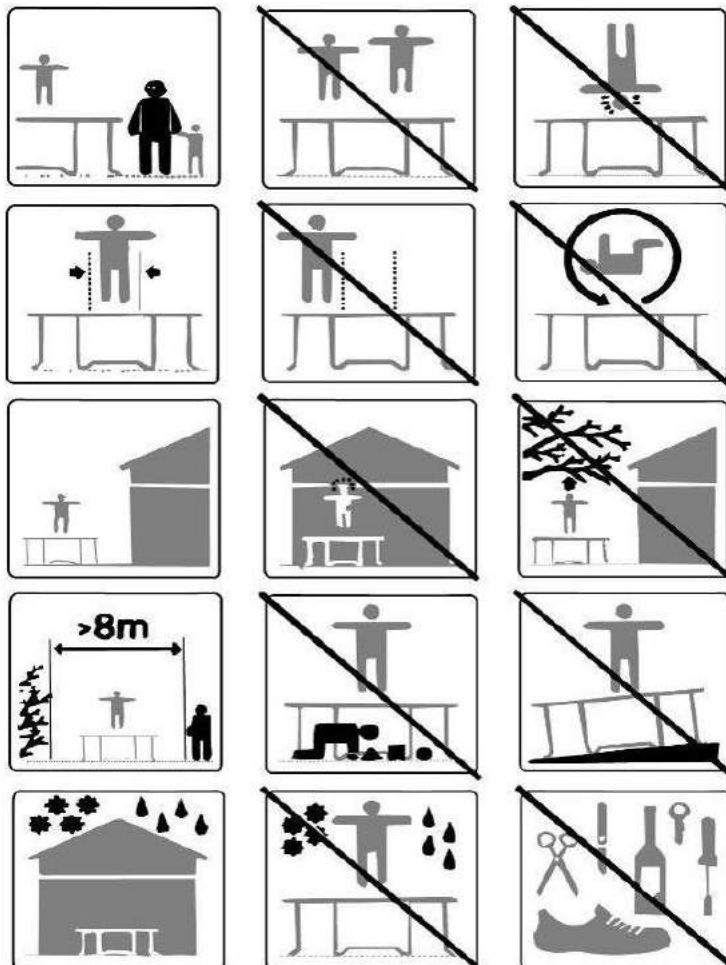

- The safety instructions of the trampoline should always be considered and obeyed.
- Using the trampoline may result in permanent injury such as paralysis, or even death. Even landings on the trampoline may lead to injuries, particularly to the back, neck or head.
- Trampolines are jumping devices, enabling the user to jump into unusual heights as well as into a multiplicity of body movements. Jumping in the Trampoline, hitting the frame, cushioning or incorrect landing on the Trampoline can lead to injuries.
- No clothes with hooks or loose parts should be worn when carried during trampoline usage in order to avoid hooks getting caught and causing injury.
- Strong winds can result in the trampoline being blown away or damaged. If strong winds are predicted the trampoline must be disassembled and moved to a sheltered area or sufficiently anchored down.
- Moving the trampoline whilst assembled may affect the integrity of the frame. Should it be necessary to move the trampoline, please consider the following:
 - 1.) At least four people must be evenly spaced around the frame to lift the trampoline off the ground
 - 2.) The trampoline must be carried horizontally
 - 3.) Use caution whilst moving as it could bend the trampoline frame. If this occurs, use four people to draw the trampoline in shape.
- Users should be familiar with the assembly manual. This manual contains assembly guidance; selected precautionary measures as well as recommendations for servicing and maintenance of the trampoline, in order to ensure a secured and fun use of the Trampoline.
- It is the responsibility of the owner or the supervisor to guarantee that all users of the trampoline are informed sufficiently of all warning references and safety instructions.

For the supervisor:

The supervisor's role is to make sure users are aware of all safety precautions and that these precautions are enforced. When a supervisor is not available, the trampoline may be disassembled or covered to limit access.

- Do not recommend this trampoline for children under 3 years of age.
- The trampoline can be only used, if the jumping mat is clean and dry. Worn or damaged jumping mats should immediately be replaced.
- Objects, which could be dangerous to the user, should be away from the trampoline
- Avoid unauthorized and unsupervised use of the trampoline.
- Do not use the trampoline under influence of alcohol or drugs (incl. medicines).
- Learn the fundamental jump and body positions carefully, before trying difficult jumps.
- Stop jumping by bending your knees when your feet come to contact with the trampoline. The skill of braking should be used whenever you lose balance or control from a previous manoeuvre. Loss of balance or control will increase the risk of injury from landing on the frame, springs or completely off the trampoline. A controlled jump is considered landing on the same spot that you took off from .If you do lose control when you are jumping on the trampoline, bend your knees sharply when you land and this will allow you to regain control and stop your jump.
- Climb onto the trampoline. Do not jump on it directly. Do not use the trampoline as jumping board for other articles.

2.1 Accident Categories

Somersaults: A landing on the head or neck increases the risk of neck and back injuries, which can lead to paralysis and sometimes death. This can occur if the user makes an error and falls forward or backward. No somersaults should be attempted on the trampoline.

Climbing on or off the trampoline: The trampoline's jumping mat is approximately one meter above the ground. Jumping off the trampoline onto the ground or another surface can lead to an injury. Jumping onto the trampoline from a building roof, a terrace or other objects can lead to injury. Small children need assistance when climbing on or off the trampoline. Be careful when climbing on and off the trampoline. Do not step on the padding or the framework. Do not use the framework for climbing on or off the trampoline.

Hitting the framework or the springs: Stay in the centre of the mat when playing jumping on the trampoline. This will reduce the risk of injury from landing on the frame or springs. Always keep the padding covering the frame of the trampoline. DO NOT jump or step onto the frame pad directly since it is not intended to support the weight of a person.

Loss of control: when users lose control of their jump, they can land incorrectly, on the framework, on the padding or fall off the trampoline. A controlled jump is one where the jumper lands and jumps from the same spot. If a manoeuvre is attempted, which exceeds the abilities of the jumper; there is a danger of losing control and increased chance of injury. In order to regain control of the jump and land correctly, knees should be completely bent upon landing.

Under influence of drugs or alcohol: The probability of an injury rises if the user is under the influence of alcohol or drugs. These substances weaken the response, the faculty of judgment, the space awareness, the co-ordination and the motor functions of the user.

Collision with objects: while using the trampoline, persons, animals or articles under it will increase the probability of an injury. Jumping on the trampoline whilst carrying an article, increases the probability of an injury. Placing the trampoline too close to electric wires, tree branches or other obstacles will also increase the probability of an injury.

Bad maintenance of the trampoline: Users can hurt themselves if the trampoline is in bad condition. A torn jumping mat, bent framework, missing cushioning or missing framework

must be replaced before using the trampoline again. The trampoline should be examined before each use.

Weather conditions: A wet jumping mat is too slippery for safe jumping. Gusty or strong winds can lead to a loss of jump control when jumping. In order to lower the probability of an injury, the trampoline should be used under suitable weather conditions only.

3 ASSEMBLY INSTRUCTIONS

MODEL	8'	10'	16'
Size	244cm	304cm	487cm
Total Height	246cm	270cm	270cm
Jumping mat	76cm	90cm	90cm

Frame Specifications

MODEL	8'	10'	16'
Frame cover	1	1	1
Jumping mat	1	1	1
Top rail	6	6	8
Metal Clips	42	60	112
Leg	6	6	8
Tools	1	1	1
Ladder	1	1	1

3.1. PARTS

- 8FT MF083801 6pcs
- 10FT MF103801 6pcs
- 12FT MF124201 8pcs
- 14FT MF144201 8pcs
- 16FT MF164201 8pcs

FRAME RAIL, TOP



- 8FT JP0842 1pcs
- 10FT JP1060 1pcs
- 12FT JP1272 1pcs
- 14FT JP1480 1pcs
- 16FT JP16112 1pcs

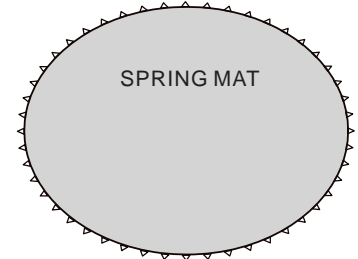

SPRING MAT

- 8FT ML3801 6pcs
- 10FT ML3802 6pcs
- 12FT ML3802 8pcs
- 14FT ML3802 8pcs
- 16FT ML3802 8pcs

LEG



- 8FT P0801 1pcs
- 10FT P1001 1pcs
- 12FT P1201 1pcs
- 14FT P1401 1pcs
- 16FT P1601 1pcs



PAD

- 8FT MF082501 6pcs
- 10FT MF102501 6pcs
- 12FT MF122501 8pcs
- 14FT MF142501 8pcs
- 16FT MF162501 8pcs

LEG BASE

TOP

BOTTOM



- 8FT S1401 42pcs
- 10FT S1401 60pcs
- 12FT S1781 72pcs
- 14FT S1781 80pcs
- 16FT S2141 112pcs

SPRINGS

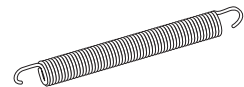

- 8FT MF082501 6pcs
- 10FT MF102501 6pcs
- 12FT MF122501 8pcs
- 14FT MF142501 8pcs
- 16FT MF162501 8pcs

FRAME RAIL, BOTTOM A



- 8FT B8638 12pcs
- 10FT B8638 18pcs
- 12FT B8642 16pcs
- 14FT B8642 24pcs
- 16FT B8642 24pcs

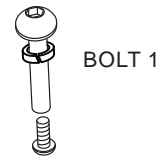

BOLT 1

- 10FT MF102502 6pcs
- 14FT MF142502 8pcs
- 16FT MF162502 8pcs

FRAME RAIL, BOTTOM B

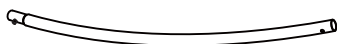

- 8FT / 10FT B6070 6pcs
- 12FT / 14FT / 16FT B6070 8pcs



BOLT 2

- 10FT B6032 6pcs
- 14FT / 16FT B6032 8pcs

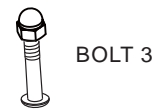

BOLT 3

Tools



SPRING TOOL



ALLEN KEY

- 8FT / 10FT MP2501 6pcs
- 12FT / 14FT / 16FT MP2501 8pcs

NET POLE, BOTTOM



- 8FT / 10FT MP2501 6pcs
- 12FT / 14FT / 16FT MP2502 8pcs

NET POLE, TOP



- 8FT / 10FT Sleeve 6pcs
- 12FT / 14FT / 16FT Sleeve 8pcs

SLEEVE



- 8FT / 10FT / 12FT / 14FT / 16FT N5110 1pcs

METAL SURROUND CIRCLE A

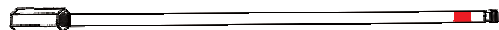

- 8FT N5111 6pcs
- 10FT N5111 8pcs
- 12FT N5111 10pcs
- 14FT N5111 12pcs
- 16FT N5111 14pcs

METAL SURROUND CIRCLE B

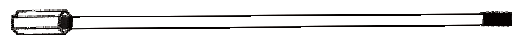

- 8FT / 10FT / 12FT / 14FT / 16FT N5112 1pcs

METAL SURROUND CIRCLE C

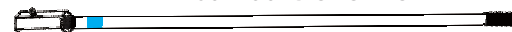

- 8FT S0801 1pcs
- 10FT S1001 1pcs
- 12FT S1201 1pcs
- 14FT S1301 1pcs
- 16FT S1401 1pcs

SAFETY NET

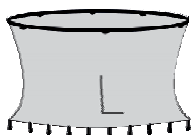

- 8FT PT252 6pcs
- 10FT PT252 6pcs
- 12FT PT252 8pcs
- 14FT PT252 8pcs
- 16FT PT252 8pcs

PLASTIC CONNECTOR A



- 8FT PT251 6pcs
- 10FT PT251 6pcs
- 12FT PT251 8pcs
- 14FT PT251 8pcs
- 16FT PT251 8pcs

PLASTIC CONNECTOR B



3.2. FRAME ASSEMBLY

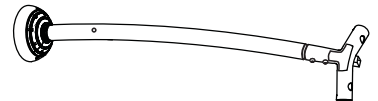
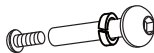
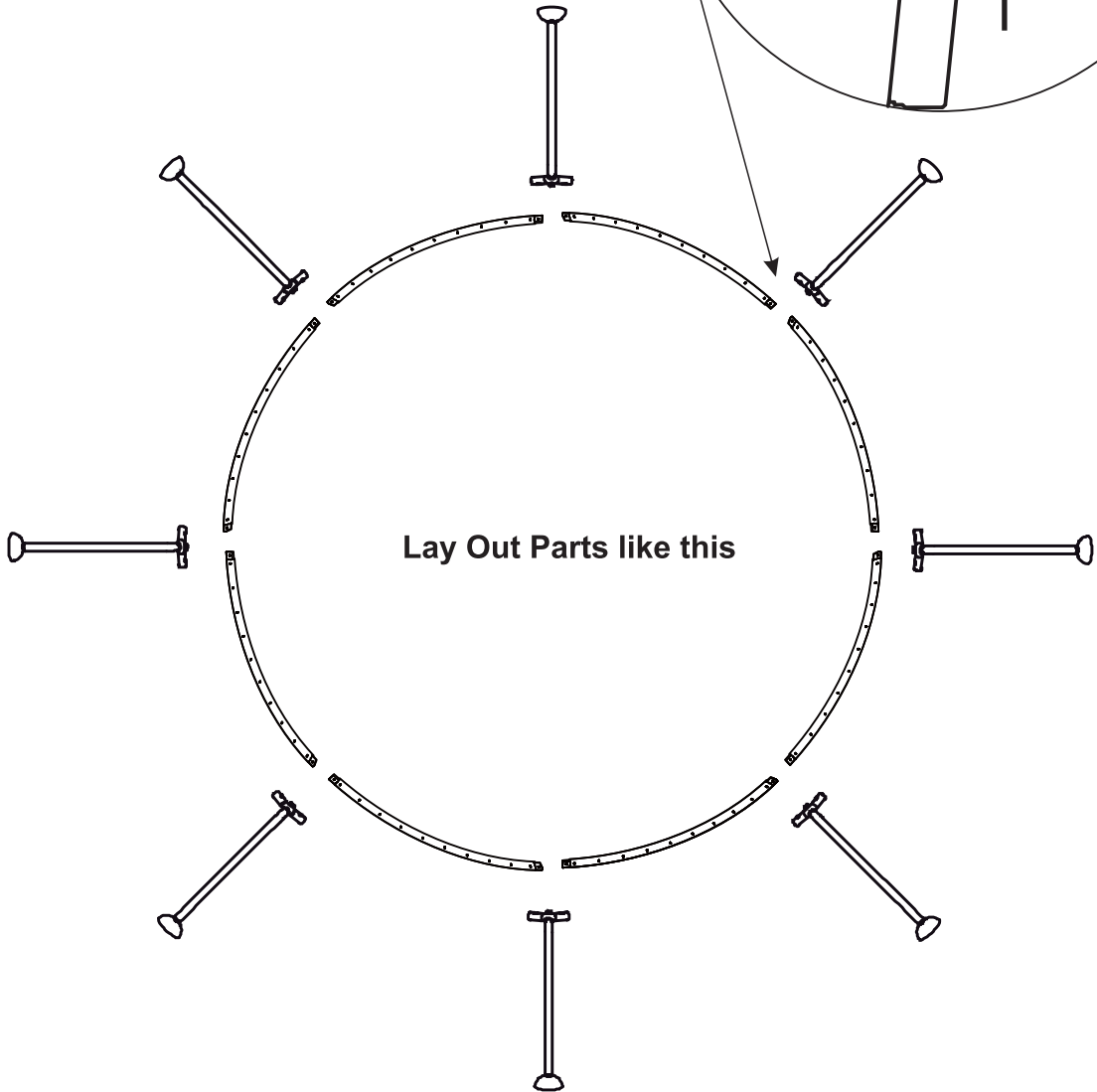
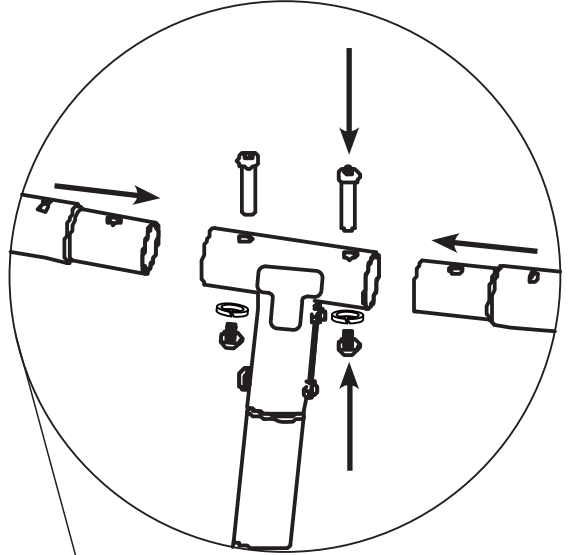
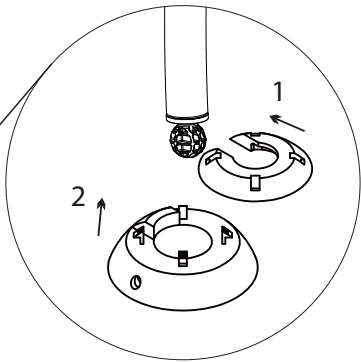
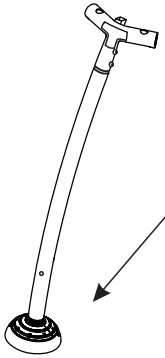
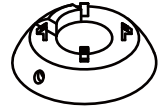

3.2. (A) 10FT, 14FT FRAME ASSEMBLY

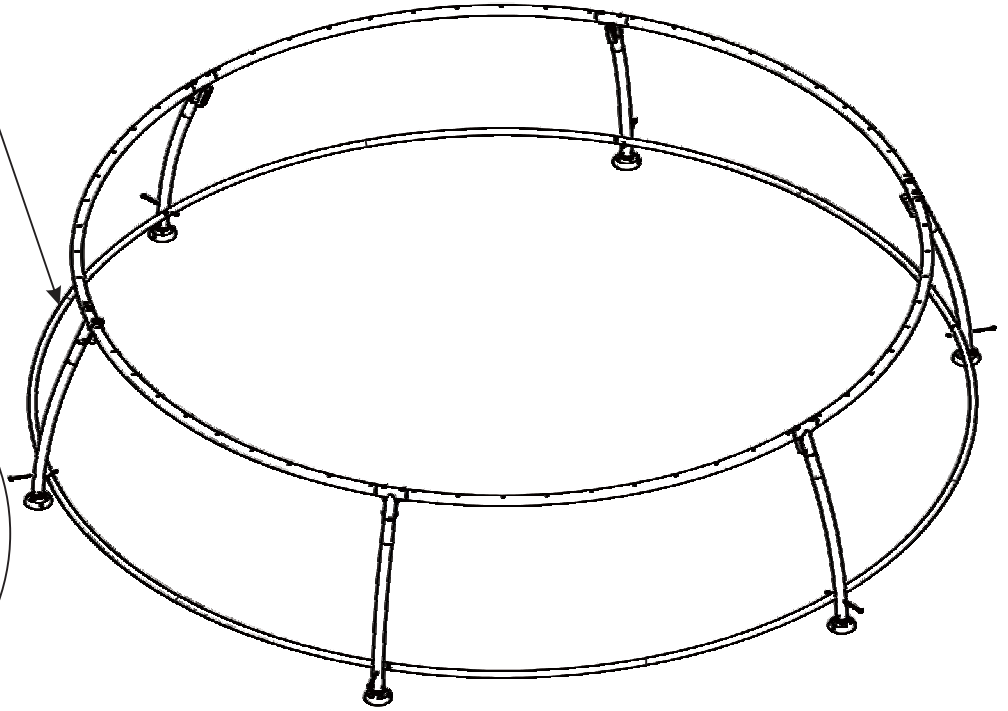
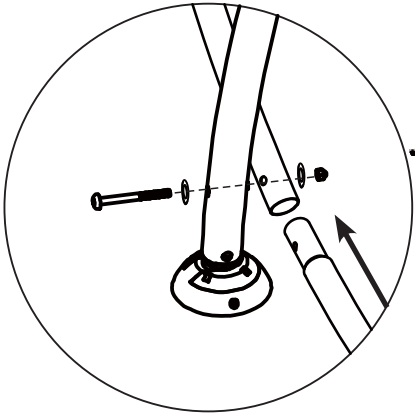
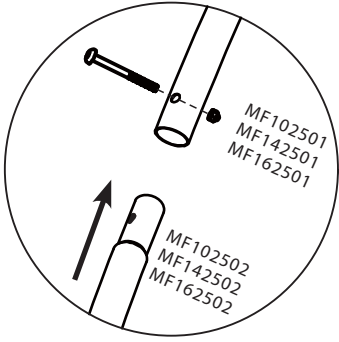
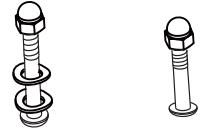

3.2. (B) 8FT, 12FT FRAME ASSEMBLY

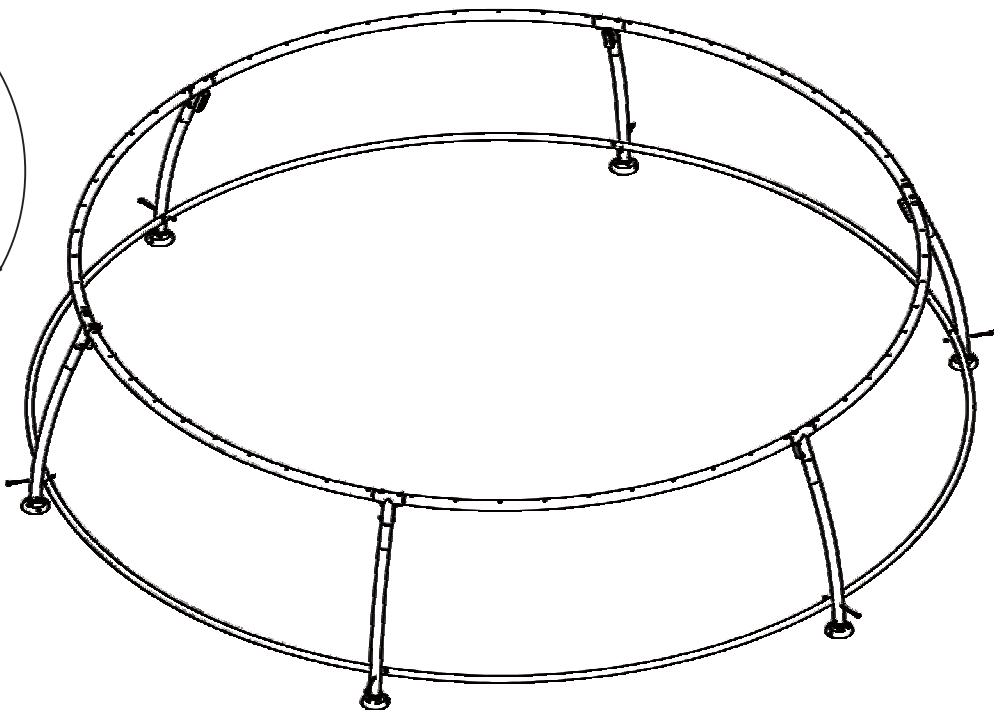
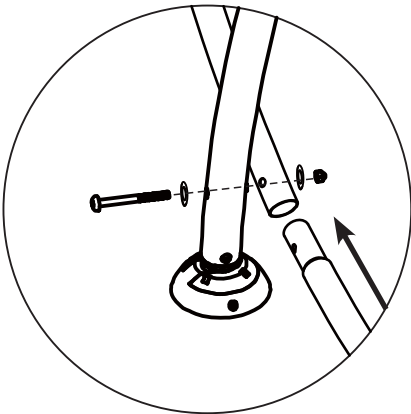

3.3. MAT ASSEMBLY

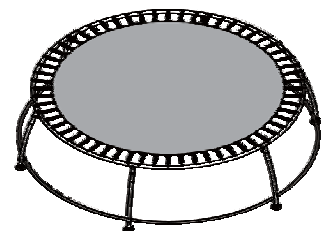
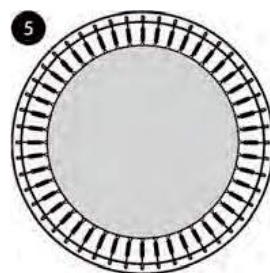
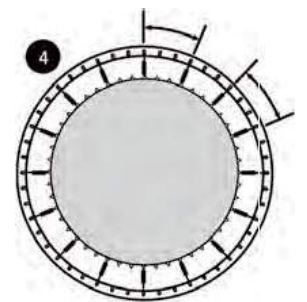
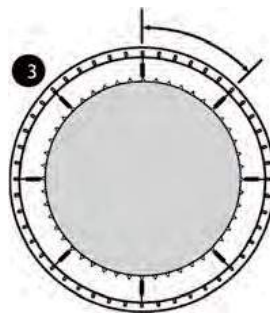
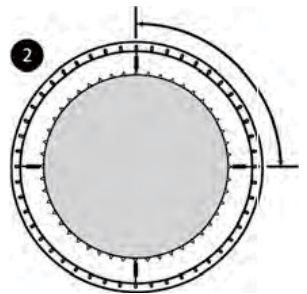
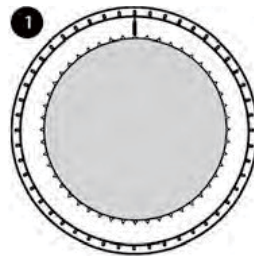
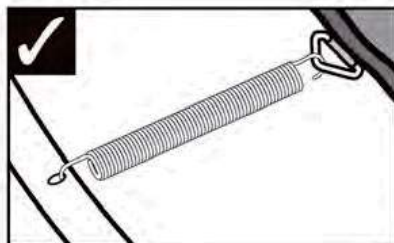
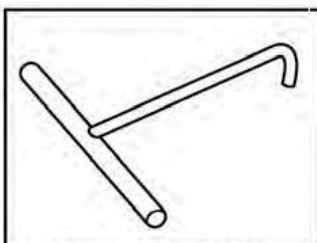
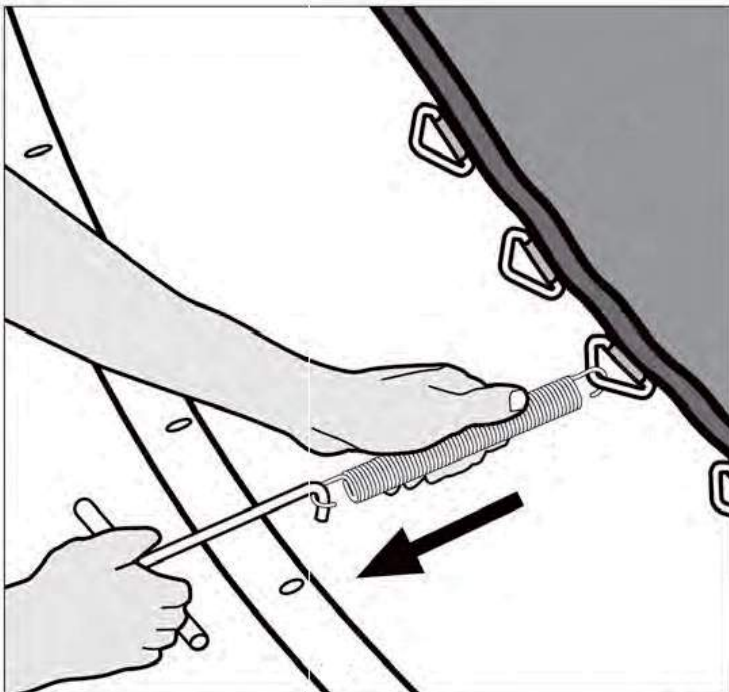
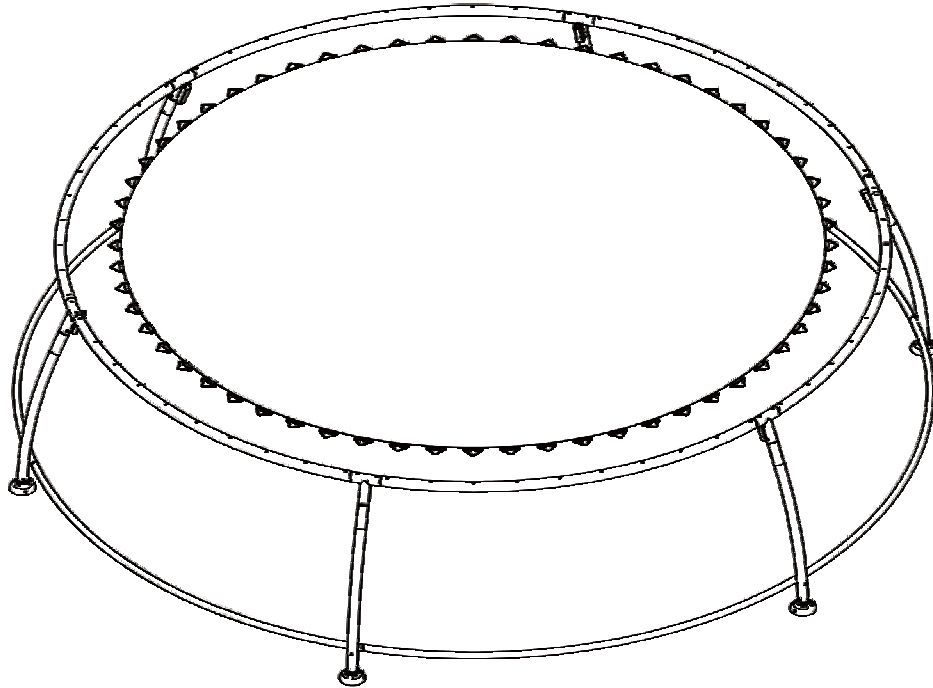
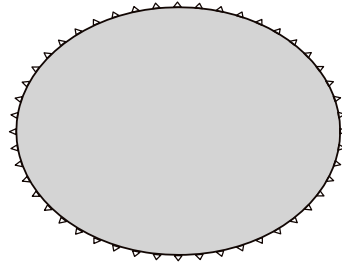
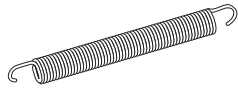

3.4. FRAME PADDING ASSEMBLY

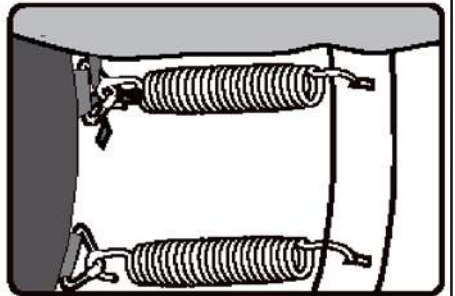
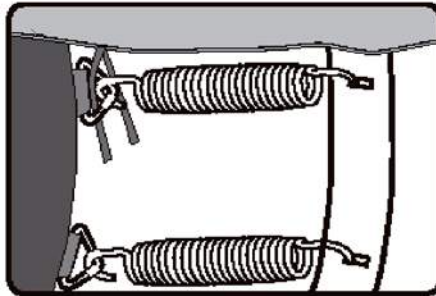
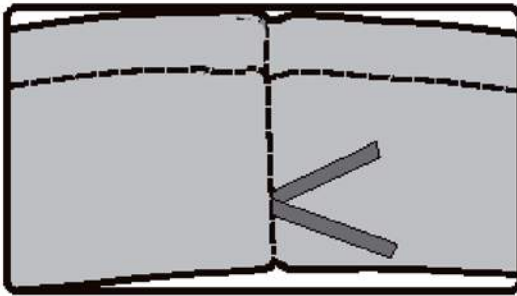
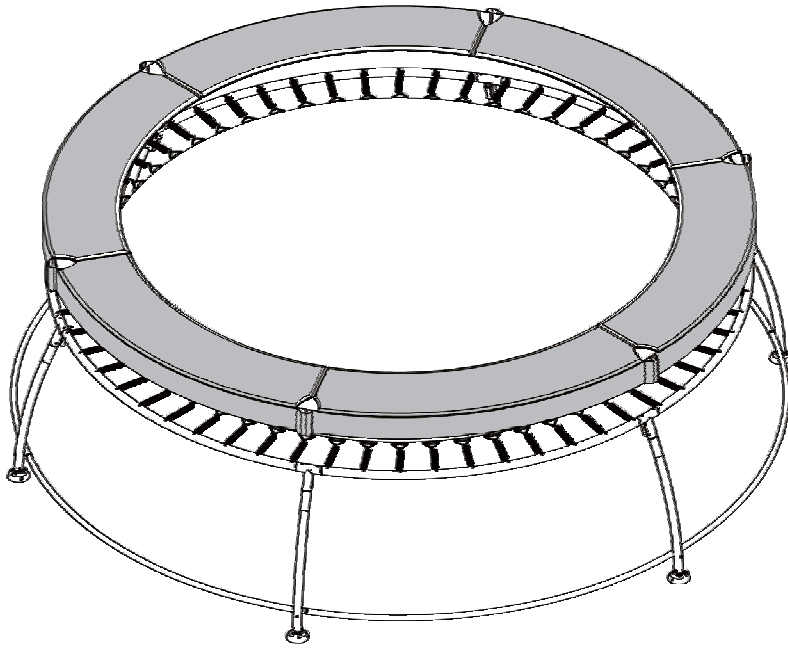

3.5. UPRIGHT POLE ASSEMBLY

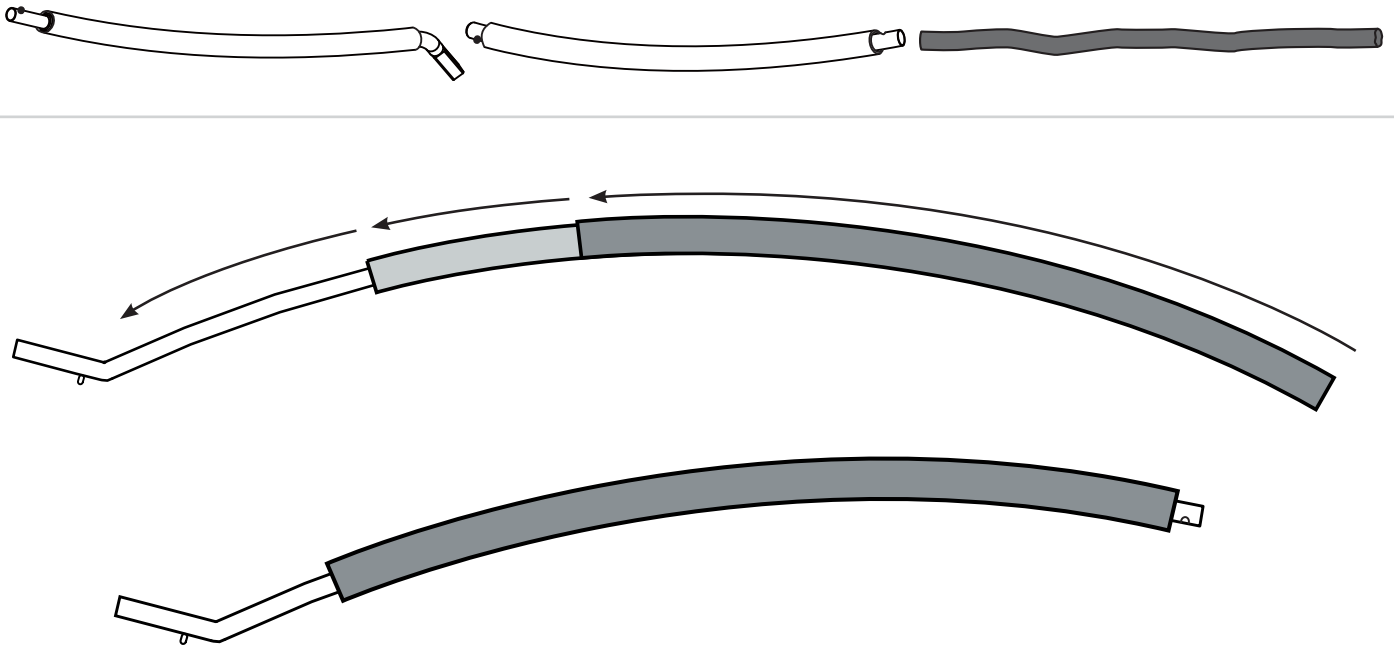

3.6. SAFETY KEY ASSEMBLY

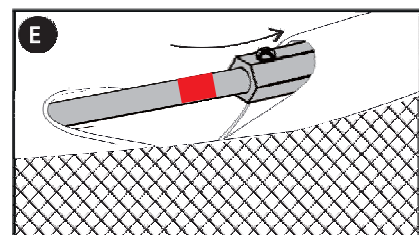
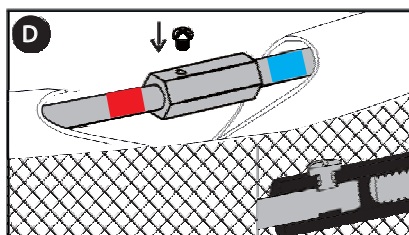
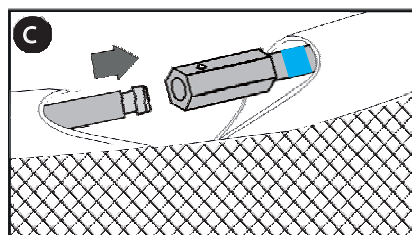
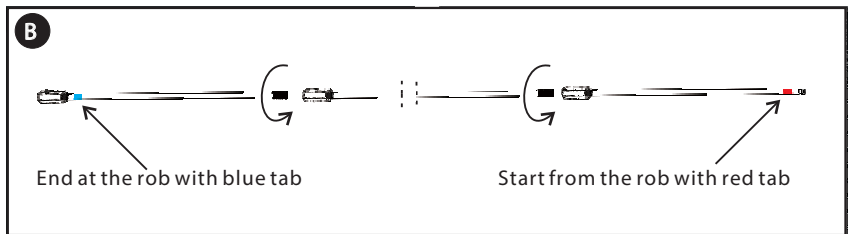
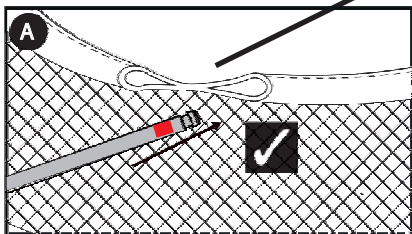
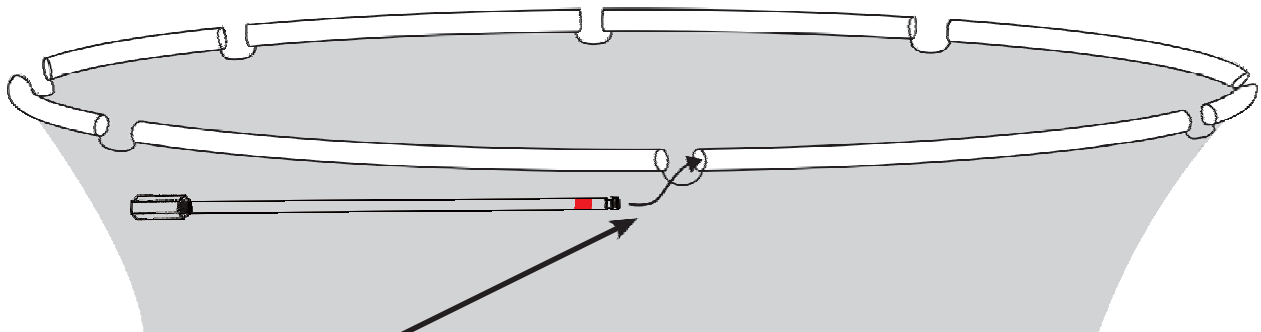
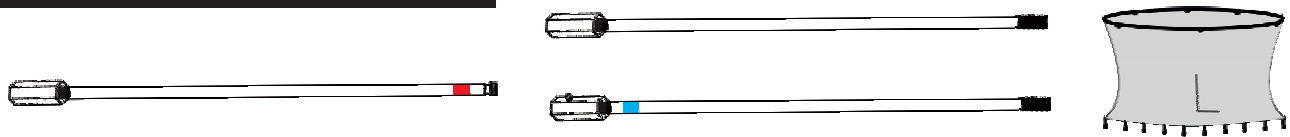

3.7. NET ATTACHMENT

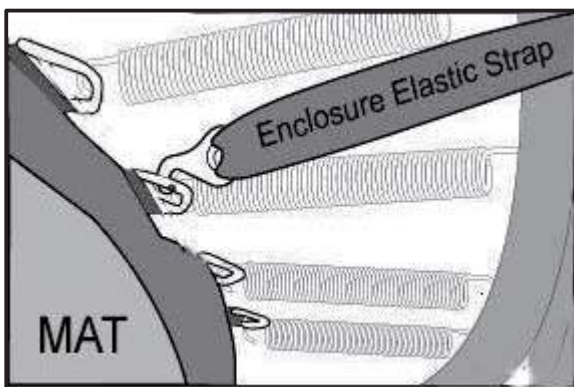
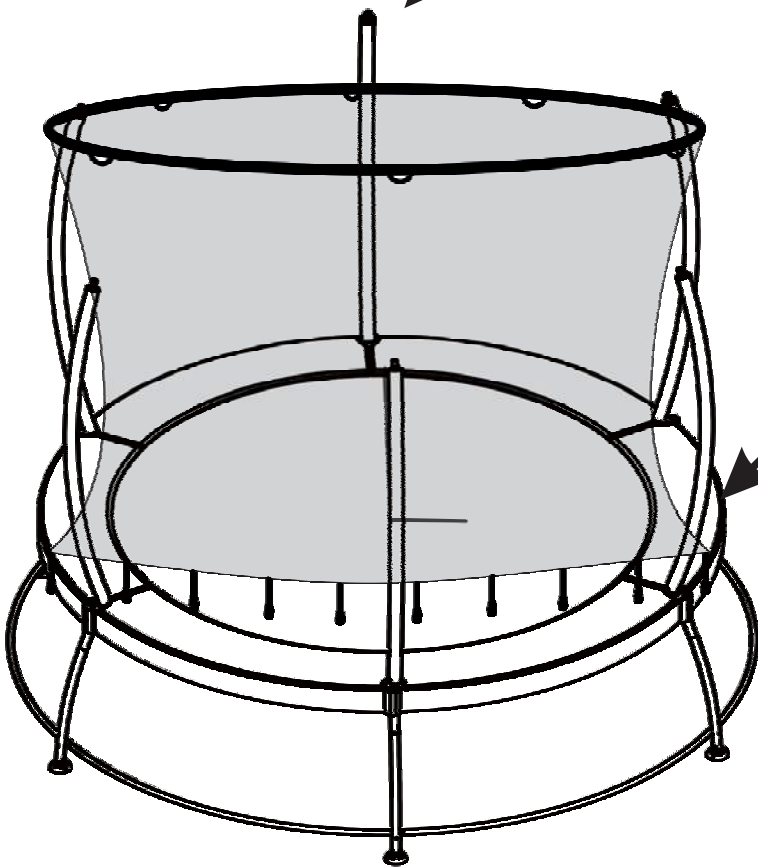
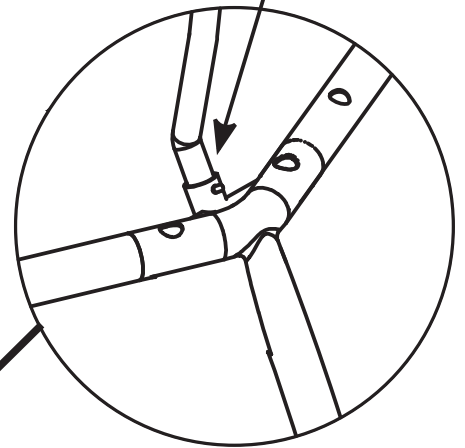
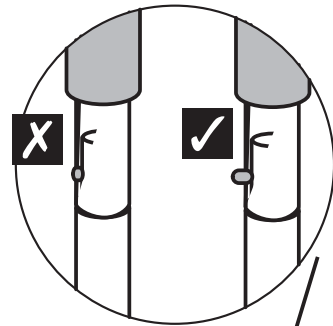
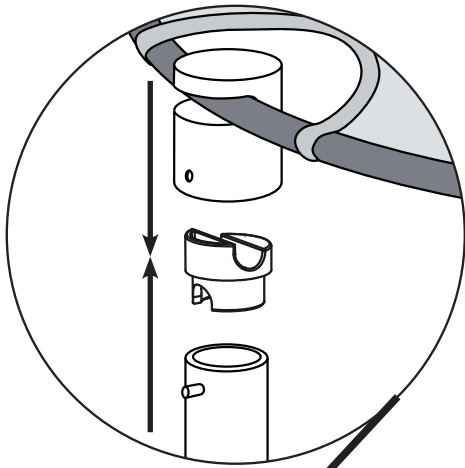
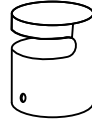

3.8. LADDER ASSEMBLY

Screw B6055 6pcs



LF2501 2pcs

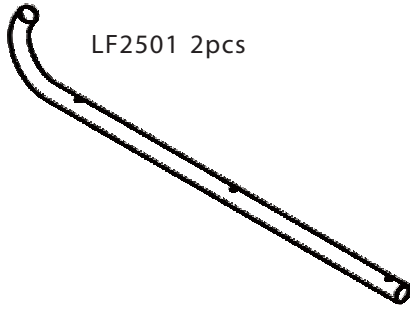

LF2502 3pcs

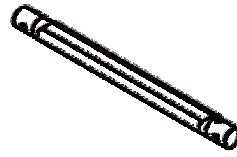

LF2503 1pcs

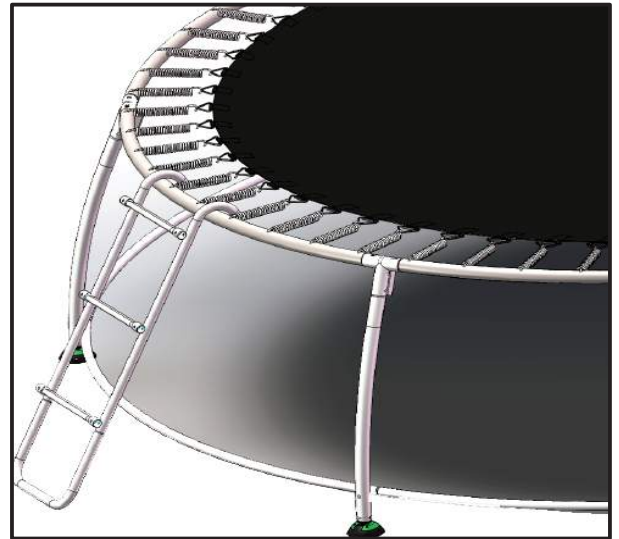
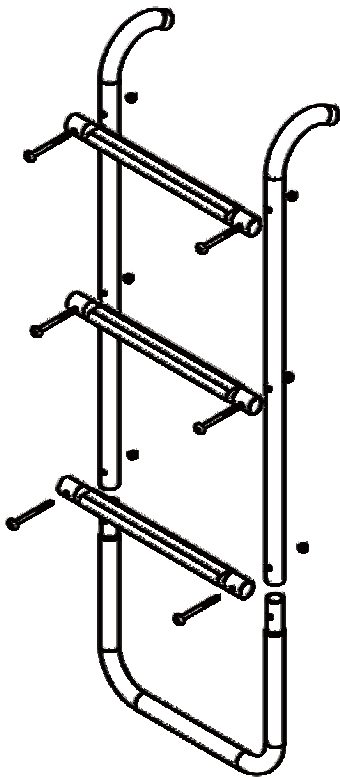
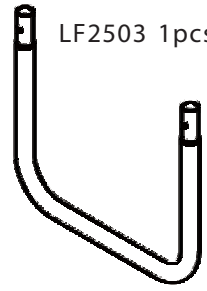

4 SAFETY NET PRECAUTIONS

In addition to the instructions and precautions provided with your trampoline, the following precautions must be observed while using the Trampoline Safety Enclosure.

- The metal frame of the trampoline enclosure will conduct electricity. Lights, extension cords, and all such electrical equipment must never be allowed to come in contact with the enclosure.
- Inspect the enclosure before each use. Make sure the straps and all parts are correctly and securely positioned and attached. Tighten any loose hardware.
- Replace any worn, defective, or missing parts.
- Wear comfortable clothing free of hooks, snaps, drawstrings for anything which or catch in the safety enclosure mesh. Remove jewellery, necklaces, and earrings.
- Climb on and off the trampoline only through the safety enclosure entrance and securely close entrance when trampoline is in use. Users, especially children, must not attempt to enter or exit between the trampoline frame and the enclosure. Doing this may pose a strangulation risk.
- Do not touch or rebound off the safety enclosure mesh while using the trampoline. Read all instructions and complete all assembly before using the safety enclosure.
- Do not touch or hang off the safety ring (fibre pipe) at the top of the enclosure
- Use trampoline and trampoline enclosure only with mature, knowledgeable supervision. Adequate overhead clearance is essential. A minimum of 9.5m from ground level is recommended. Provide clearance for wires, tree limbs, and other possible hazards. Lateral clearance is essential. Place the trampoline and

trampoline enclosure away from walls, structures, fences, and other play areas.

Maintain a clear space on all sides of the trampoline and trampoline enclosure. A minimum of 2 metres from frame edge is recommended.

- The trampoline is heavy and is under heavy tension. Three adults are required to set it up. Use appropriate clothing and shoes. Failure to follow these instructions may lead to injury or damage to the trampoline.
- Place the trampoline and trampoline enclosure on a level surface before use.
- Use the trampoline and trampoline enclosure in a well-lit area. Artificial illumination may be required for indoor or shady areas.
- Secure the trampoline and trampoline enclosure against unauthorized and unsupervised use.
- Remove any obstructions from beneath the trampoline and trampoline enclosure.
- The owner and supervisors of the trampoline and trampoline enclosure are responsible to make all users aware of practices specified in the “Use Instructions”.
- The trampoline enclosure is only to be used as an enclosure for a trampoline and the trampoline must be of the appropriate size covered by the specific enclosure.
- Do not allow more than one person on the trampoline or inside the trampoline enclosure. Use by more than one person at the same time can result in serious injuries.
- Use trampoline and trampoline enclosure only with mature, knowledgeable supervision.
- Never set-up the trampoline in heavy rain, wind or storm conditions, especially lightning storms. It is recommended that the trampoline be taken apart and stored in bad weather. When moving the assembled trampoline and trampoline enclosure have at least four people evenly spaced around the frame (NSEW) to lift the trampoline off the ground. Inspect that trampoline and trampoline

enclosure before each use. Make sure that frame cover, barrier and, enclosure support padding are correctly and securely positioned.

- Replace any worn, defective, or missing parts.

5 MAINTENANCE

Inspect the trampoline and trampoline enclosure before each use and replace any worn, defective, or missing parts.

The following conditions could represent potential hazards:

1. Missing, improperly positioned, or insecurely attached frame padding, barrier or enclosure support system (frame) padding and pole caps.
2. Punctures, frays, tears, or holes worn in the bed or frame padding, barrier or enclosure support system (frame) padding and pole caps.
3. Deterioration in the stitching or fabric of the bed or frame padding, barrier or enclosure support system (frame) padding and pole caps.
4. Ruptured springs or bands.
5. A bent or broken frame or support system.
6. A sagging barrier or bed.
7. Sharp protrusions on the support (frame) or suspension system.
8. Loosened or missing hardware.

6 CLEANING

Do not use any abrasive cleansers for the cleaning. Use a soft, damp cloth to eliminate dirt and dust.

7 EXERCISE DIAGRAMS

FUNDAMENTAL BOUNCES

STANDING BOUNCE



KNEE BOUNCE



FRONT DROP



HANDS & KNEE DROP



BACK DROP



SEAT DROP



TUCK POSITION



PIROUETTE



PIKE POSITION



STRADDLE POSITION

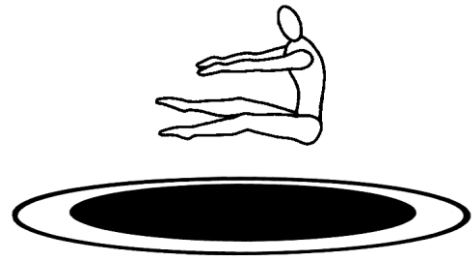

LAYOUT POSITION



8 WARRANTY

AUSTRALIAN CONSUMER LAW

Many of our products come with a guarantee or warranty from the manufacturer. In addition, they come with guarantees that cannot be excluded under the Australian Consumer law. You are entitled to a replacement or refund for a major failure and compensation for any other reasonably foreseeable loss or damage.

You are entitled to have the goods repaired or replaced if the goods fail to be of acceptable quality and the failure does not amount to a major failure. Full details of your consumer rights may be found at www.consumerlaw.gov.au

Please visit our website to view our full warranty terms and conditions:

<http://www.lifespankids.com.au/Warranty-Policy-Kids>

Please send all warranty and support inquiries through our ticketing system via the email address: support@lifespankids.com.au.

Head Office and Customer Service:

Global Fitness and Leisure Pty Ltd
17 Fordson Rd
Campbellfield
VIC, 3061
Australia
PH: 03 9357 2166