

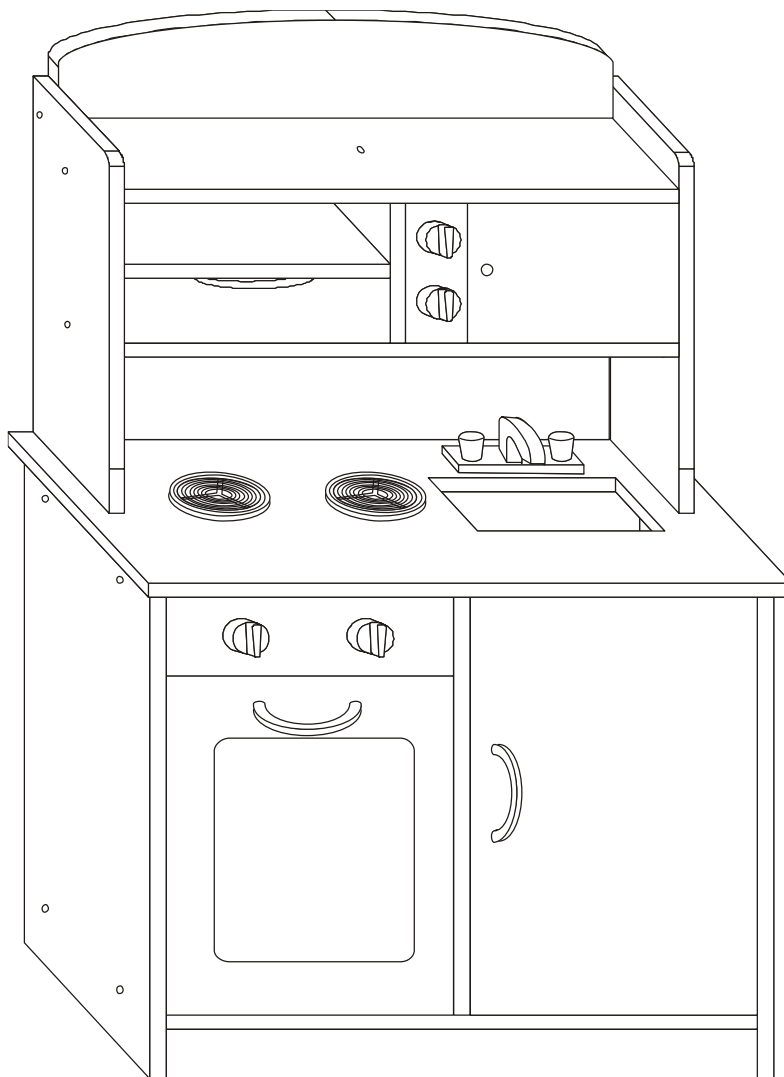

# LK39 AL DENTE PLAY KITCHEN

## OWNER'S MANUAL



### WARNING!

The disassembled product may contain small parts which pose a choking hazard to children under 3.

### IMPORTANT:

This product may contain sharp points and small parts prior to assembly.

The owner's manual contains safety, assembly, use and maintenance instructions. This product must be assembled by an adult who has read and understood these instructions. Keep the packaging away from children and dispose of all packaging before use.

For the installer and your children's safety, it is important to fully read and understand the instructions and safety hazards before commencing the assembly of the product.



# TABLE OF CONTENTS

1.	GENERAL SAFETY	3
1.1	DANGER FOR CHILDREN	3
1.2	RISK OF INJURIES	3
1.3	PRODUCT DAMAGE	3
1.4	ASSEMBLY ADVICE	3
2.	SAFETY INSTRUCTIONS	4
3.	ASSEMBLY INSTRUCTIONS	5
4.	MAINTENANCE	8
5.	CLEANING	8
6.	WARRANTY	9

# 1 GENERAL SAFETY

This product is intended for indoor domestic use only.

## 1.1 DANGER FOR CHILDREN

### **WARNING! No eating while using the product**

- Children do not recognize potential dangers from this product. The product must be stored out of reach of children and pets.
- This product may only be used with adult supervision at all times.
- The packaging material is not suitable for children due to choking and suffocation hazards.

## 1.2 RISK OF INJURIES

- Do not use the product if it is damaged or defective. If it is damaged or defective, please contact a qualified technician.
- Check the product before each use. Defective parts must be changed immediately as they can impair the function and the safety of the product.
- No more than one person to use the product at the same time.
- Use the product only on even and non-slipping surfaces. Never use it near water and keep sufficient space around for safety.
- Beware of moving parts such as the springs or elastics, which could catch your arms and legs. Do not place any objects or body parts in the product's openings.

## 1.3 PRODUCT DAMAGE

- Do not make alterations to the product. Only use original spare parts. Qualified technicians should only carry out repairs – improper repairs can lead to danger for the user. Use this product only as described in this manual.

## 1.4 ASSEMBLY ADVICE

- The assembly of the product must be done carefully and by an able-bodied adult. If in any doubt, ask a technically qualified person.
- Before you start with the assembly, read the instructions carefully.
- Remove all packaging materials and lay down all parts on an open space. This gives you an overview and simplifies the assembly procedure.
- Check with the parts list that all parts are available. Dispose of the packaging material when the assembly is completed.
- Beware that when using tools or doing technical work, there is always a risk of injuries. Assemble the product with care.
- Create a danger free environment; for example, do not let tools lay around the workspace. Store the packaging material in a way that cannot cause any danger.

- After installing the product according to the instruction manual, ensure all screws, bolts and nuts are correctly installed and tightened and that all joints are secure.
- The product must be assembled correctly before use.
- Your play structure must be installed on a flat horizontal surface with a minimum of 2m between it and any structure or obstacle.
- Modifications made to the original product shall be carried out according to the instructions of the manufacturer.
- The product must always be used in a well-lit area.
- Do not place anything under the product.
- Use gloves during assembly and disassembly.
- We strongly recommend visual inspections every 3 months to insure the integrity of the entire product. Replace any parts as necessary.

## **2 SAFETY INSTRUCTIONS**











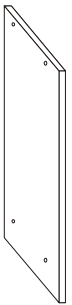
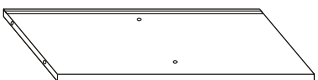
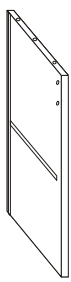

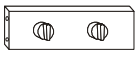
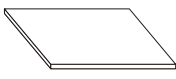
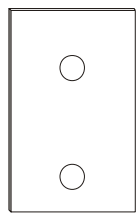
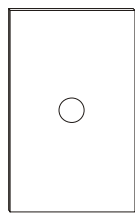

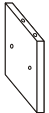

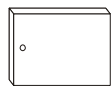

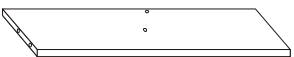
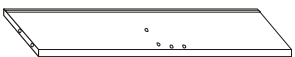
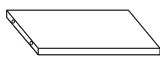

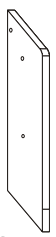
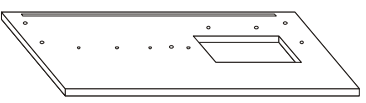

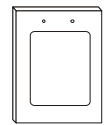
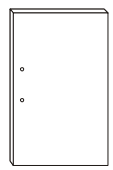

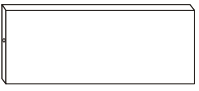
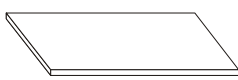
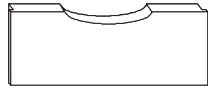







- The safety instructions of the product should always be considered and obeyed.
- No clothes with hooks or loose parts should be worn or carried during product usage in order to avoid hooks getting caught and causing injury.
- Moving the product whilst assembled may affect the integrity of the frame. Should it be necessary to move the product, please consider the following:
  - 1.) Force to be evenly spaced around the frame to lift the product off the ground
  - 2.) The product must be carried horizontally
  - 3.) Use caution whilst moving as it could bend the product frame.
- Users should be familiar with the assembly manual. This manual contains assembly guidance; selected precautionary measures as well as recommendations for servicing and maintenance of the product, in order to ensure a secured and fun use of the product.
- It is the responsibility of the owner or the supervisor to guarantee that all users of the product are informed sufficiently of all warning references and safety instructions.

### For the supervisor:

The supervisor's role is to make sure users are aware of all safety precautions and that these precautions are enforced. When a supervisor is not available, the product may be disassembled or covered to limit access.

- The product can be only used if it is in good condition, worn or damaged parts should be replaced.
- Objects, which could be dangerous to the user, should be away from the product
- Avoid unauthorized and unsupervised use of the product.
- Do not use the product under influence of alcohol or drugs (incl. medicines).
- Do not use the product as a jumping platform for other articles.

# 3 ASSEMBLY INSTRUCTIONS

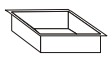
 1: 1PC	 2: 1PC		 5: 1PC	 6: 1PC		 9: 1PC
	 3: 1PC	 4: 1PC		 7: 1PC	 8: 1PC	
 10: 1PC	 11: 1PC	 12: 1PC	 13: 1PC	 14: 1PC		
 15: 1PC	 16: 1PC		 17: 1PC	 18: 1PC		
 19: 1PC	 20: 1PC		 21: 1PC	 22: 1PC	 23: 1PC	
 24: 2PCS	 25: 1PC	 26: 1PC	 27: 1PC	 28: 1PC	 29: 1PC	
				 30: 2PCS	 31: 1PC	
 A: 22PCS	 B: 6PCS	 C: 4PCS	 D: 4PCS	 E: 28PCS	 F: 27PCS	 G: 2PCS
 H: 2PCS	 I: 4PCS	 J: 2PCS	 K: 2PCS	 L: 2PCS	 M: 4PCS	 N: 1PC

### STEP 1

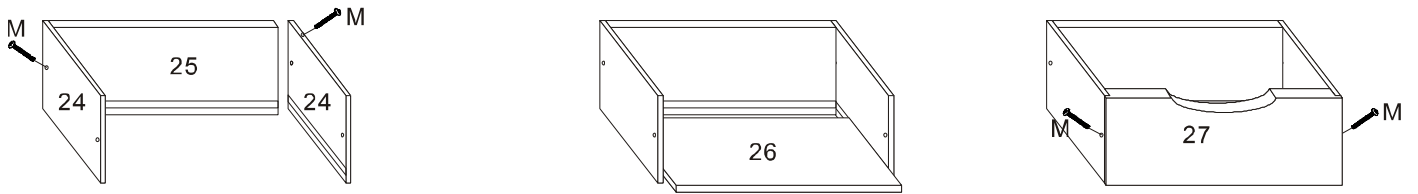

### STEP 2

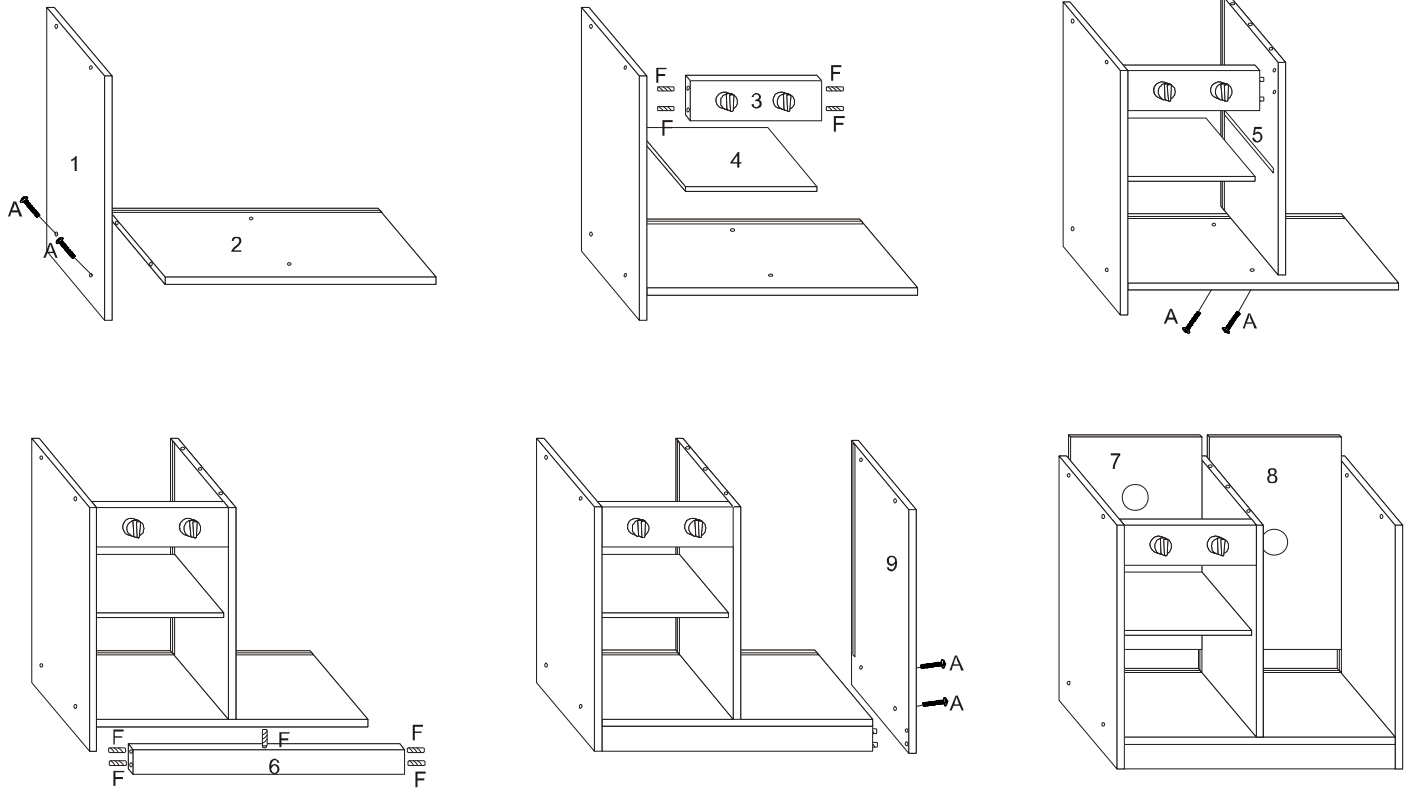

### STEP 3

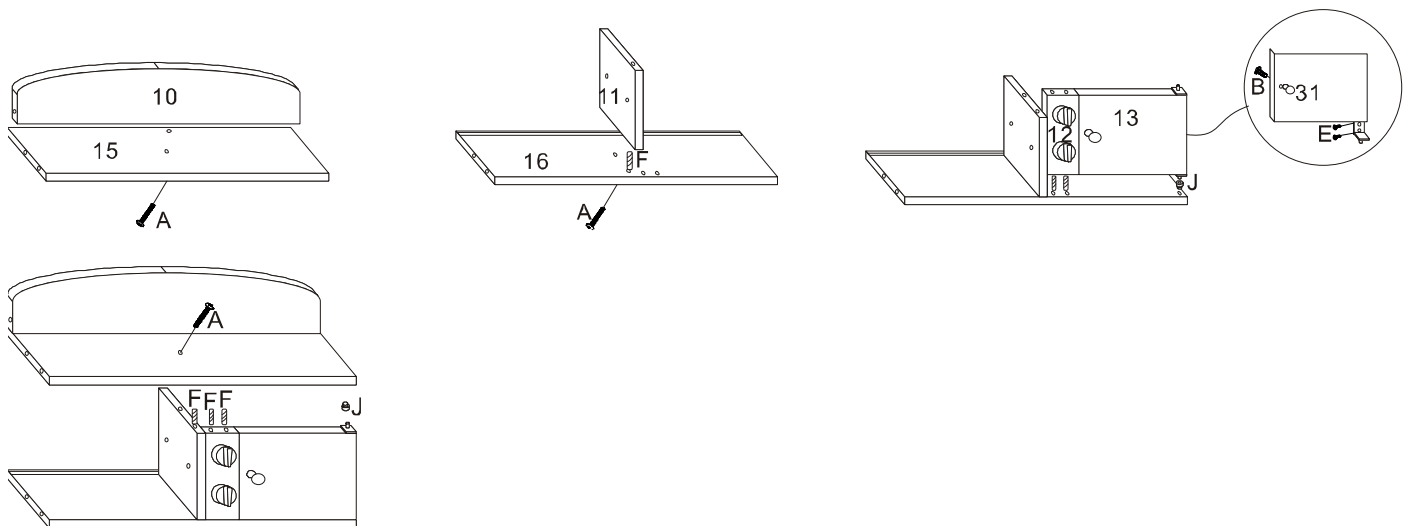

## STEP 4

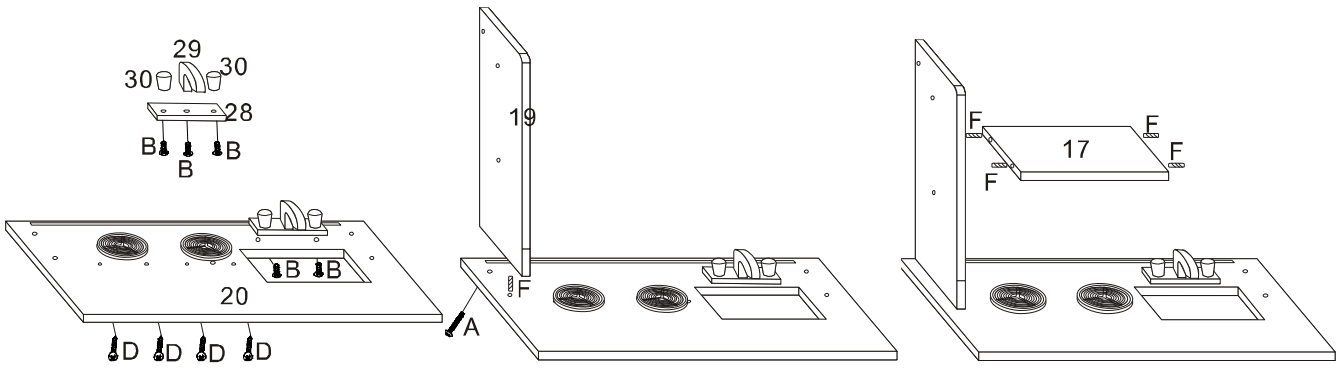

## STEP 5

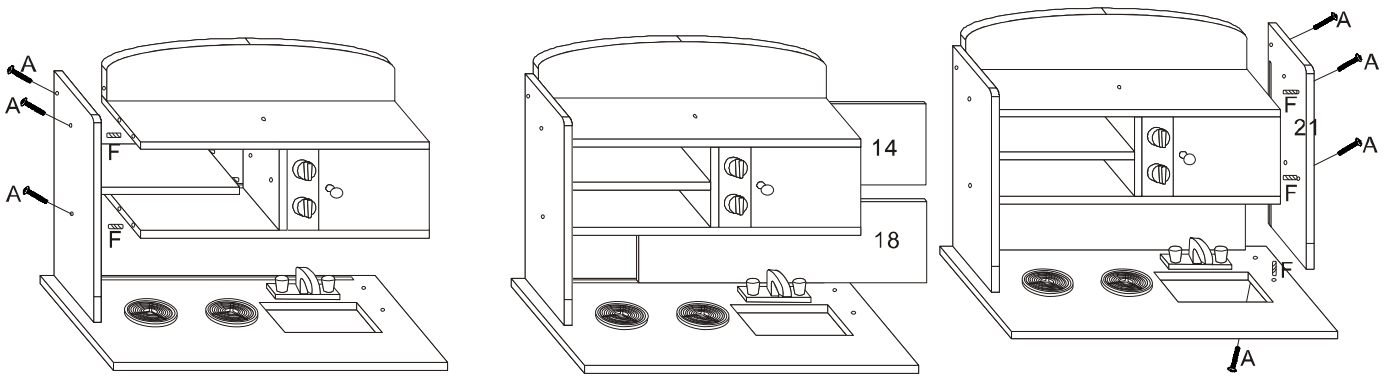

## STEP 6

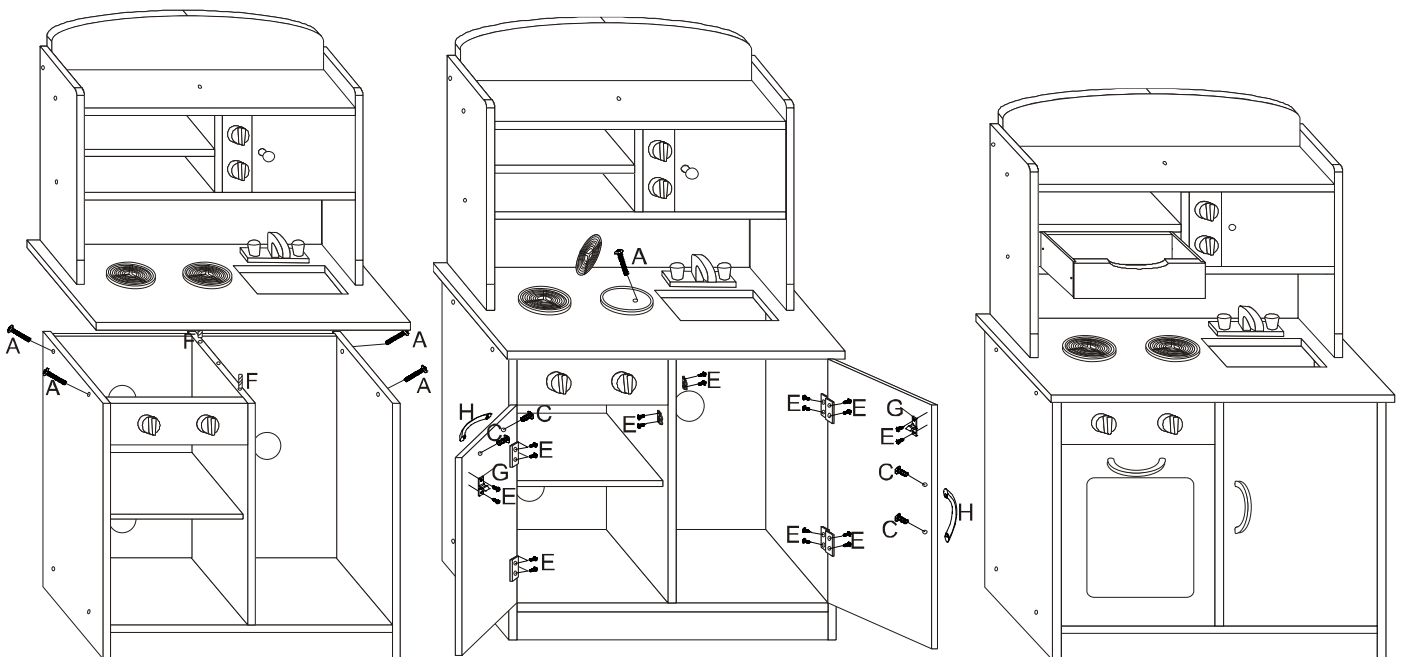

## 4 MAINTENANCE

WARNING: Please keep for future reference

We recommend regular maintenance to be conducted at the beginning of each season as well as at regular intervals during the usage session for your play equipment to ensure all main parts/fixings are tightly secured, well-oiled and intact to avoid failure, injury or hazards.

### GENERAL ADVICE

It is of particular importance that this is followed at the beginning of each season as well as at regular intervals during the usage season.

1. Check the accessories monthly as well as the play equipment's structure in order to prevent falling risks.
2. Check and retighten screws, bolts and all other hardware elements as necessary.
  - a. Do not over tighten to avoid damaging the thread or cracking the surrounding wood.
3. Check all coverings and bolts for sharp edges and replace when required.
4. Lubricate all moving metallic parts.
5. When signs of oxidation and / or rust appear on various metallic parts of your equipment, sand rusted areas and tubular members and repaint using a non-lead based paint when required.
6. Where applicable: check swing seats, chains, ropes and other means of attachment for evidence of deterioration.
7. Replace when required in accordance with the owner's manual.

If your play structure is disassembled, be sure to clearly mark any attached metal plates to prevent accidents. Check all bolt covers and sharp edges and replace them if necessary.

## 5 CLEANING

Do not use any abrasive cleansers for the cleaning. Use a soft, damp cloth to eliminate dirt and dust.



# 6 WARRANTY

## AUSTRALIAN CONSUMER LAW

Many of our products come with a guarantee or warranty from the manufacturer. In addition, they come with guarantees that cannot be excluded under the Australian Consumer law. You are entitled to a replacement or refund for a major failure and compensation for any other reasonably foreseeable loss or damage.

You are entitled to have the goods repaired or replaced if the goods fail to be of acceptable quality and the failure does not amount to a major failure. Full details of your consumer rights may be found at [www.consumerlaw.gov.au](http://www.consumerlaw.gov.au)

Please visit our website to view our full warranty terms and conditions:

<http://www.lifespankids.com.au/Warranty-Policy-Kids>

Please send all warranty and support inquiries through our ticketing system via the email address:

[support@lifespankids.com.au](mailto:support@lifespankids.com.au).