

# USER MANUAL

## Darlington Play Centre with 2.2m Slide

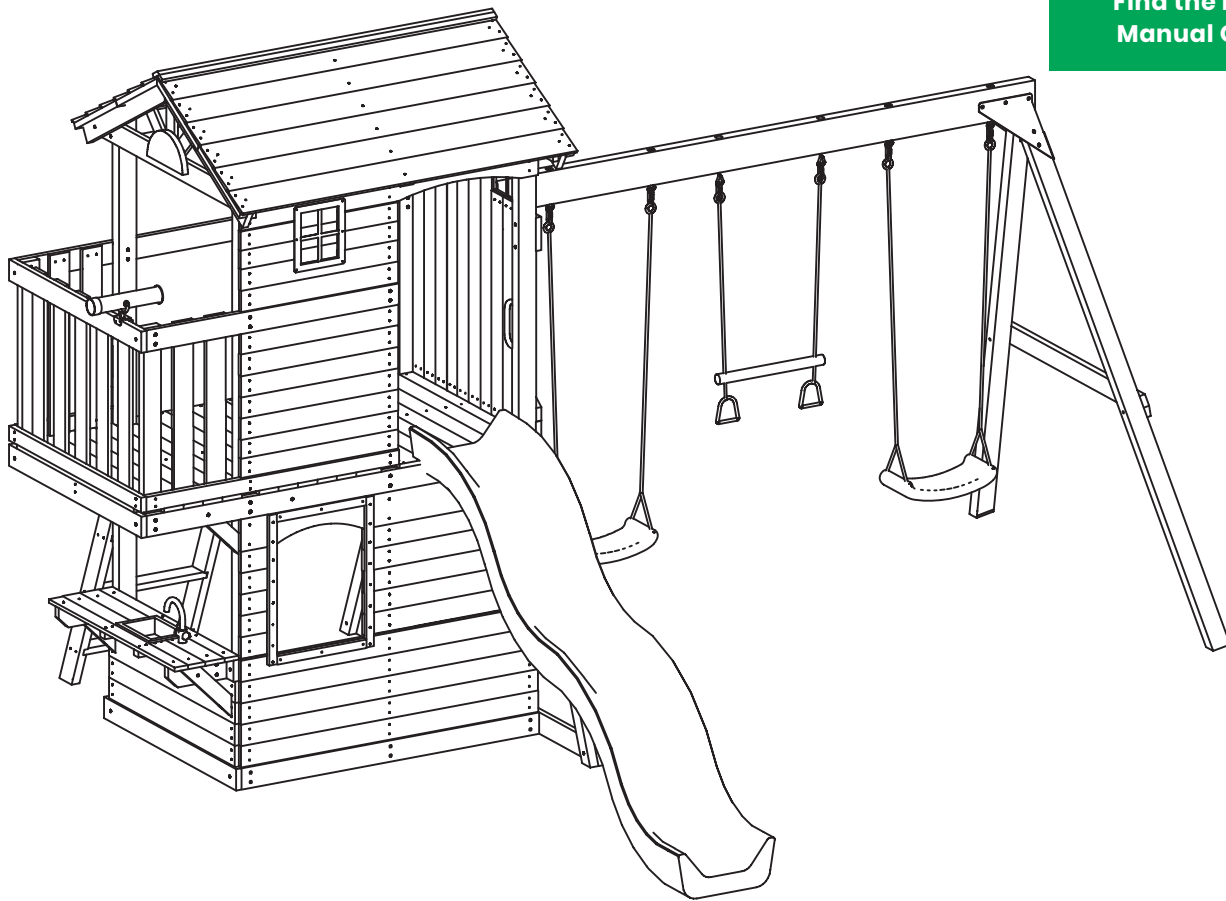

Find the Digital  
Manual Online



**WARNING:** The disassembled product may contain small parts which pose a choking hazard to children under 3.

### IMPORTANT:

This product may contain sharp points and small parts prior to assembly. The owner's manual contains safety, assembly, use and maintenance instructions. This product must be assembled by an adult who has read and understood these instructions. Keep the packaging away from children and dispose of all packaging before use.

*For the installer and your children's safety, it is important to fully read and understand the instructions and safety hazards before commencing the assembly of the product.*

### NOTE:

This manual should not be used to guide your purchasing decision. Your product, and the contents inside its carton, may vary from what is listed in this manual. This manual may also be subject to updates or changes. Updated manuals are available through our website at [www.lifespankids.com.au](http://www.lifespankids.com.au).

---

# TABLE OF CONTENTS

<b>I. GENERAL SAFETY INSTRUCTIONS</b>	3
1.1 Danger for Children	3
1.2 Risk of Injuries	3
1.3 Product Damage	3
1.4 Assembly Advice	4
<b>II. SAFETY INSTRUCTIONS</b>	5
<b>III. ASSEMBLY INSTRUCTIONS</b>	7
<b>IV. MAINTENANCE</b>	58
<b>V. FREQUENTLY ASKED QUESTIONS</b>	59
<b>VI. WOOD ADVICE</b>	60
<b>VII. WARRANTY</b>	62



---

# I. GENERAL SAFETY INSTRUCTIONS

**NOTE:** This product is intended for outdoor domestic use only.

## 1.1 DANGER FOR CHILDREN



**WARNING:** No eating while using the product at the same time.

- Children do not recognize potential dangers from this product. The unassembled product must be stored out of reach of children and pets.
- This product may only be used with adult supervision at all times.
- The packaging material is not suitable for children due to choking and suffocation hazards.

## 1.2 RISK OF INJURIES

- Do not use the product if it is damaged or defective. If it is damaged or defective, please contact a qualified technician.
- Check the product before each use. Defective parts must be changed immediately as they can impair the function and the safety of the product.
- Adhere to the weight loading and user at a time as specified on the product manual or website product specifications.
- Use the product only on even and non-slipping surfaces. Never use it near water and keep sufficient space around for safety.
- Beware of moving parts such as the springs or elastics, which could catch your arms and legs. Do not place any objects or body parts in the product's openings.

## 1.3 PRODUCT DAMAGE

- Do not make alterations to the product. Only use original spare parts. Qualified technicians should only carry out repairs – improper repairs can lead to danger for the user. Use this product only as described in this manual.

## 1.4 ASSEMBLY ADVICE

- The product should not be installed over concrete, asphalt or any hard surface. We recommend installing on grass area or dirt ground with playground wood-chips (mulch) or other impact absorbing ground cover on top (see page 6).
- The assembly of the product must be done carefully and by an able-bodied adult. If in any doubt, ask a technically qualified person.
- Before you start with the assembly, read the instructions carefully.
- Remove all packaging materials and lay down all parts on an open space. This gives you an overview and simplifies the assembly procedure.
- Check with the parts list that all parts are available. Dispose of the packaging material when the assembly is completed.
- Beware that when using tools or doing technical work, there is always a risk of injuries. Assemble the product with care.
- Create a danger free environment; for example, do not let tools lay around the workspace. Store the packaging material in a way that cannot cause any danger.
- After installing the product according to the instruction manual, ensure all screws, bolts and nuts are correctly installed and tightened and that all joints are secure.
- Reasonable space must be kept between the product and possible sources of danger, such as other equipment swimming pools and fences.
- The product must be assembled correctly before use.
- Your play structure must be installed on a flat horizontal surface with a minimum of 2m between it and any structure or obstacle such as a fence, garage house, tree branches, cloths lines, or electric cables.
- Modifications made to the original product shall be carried out according to the instructions of the manufacturer.
- The product must always be used in a well-lit area.
- Do not place anything under the product.
- Use gloves during assembly and disassembly.
- Outdoor products should be equipped with devices to prevent displacement in strong wind conditions (e.g. steel bars in the ground or loads like sandbag or water bags).
- In certain areas during winter, snow buildup and the low temperatures can damage the product. It is recommended to remove snow buildup and to store the product indoors.
- We strongly recommend visual inspections every 3 months to ensure the integrity of the entire product. Replace any parts as necessary.

---

## II. SAFETY INSTRUCTIONS

A maximum of 68 kgs. per child is recommended for play activities designed for individual use.  
A maximum of 54 kgs. per child is recommended for play activities designed for multiple child use.  
A maximum of 9 children is recommended for this swing set.

- The safety instructions of the product should always be considered and obeyed.
- No clothes with hooks or loose parts should be worn or carried during product usage in order to avoid hooks getting caught and causing injury.
- Strong winds can result in the product being blown away or damaged. If strong winds are predicted the product must be disassembled and moved to a sheltered area or sufficiently anchored down.
- Moving the product whilst assembled may affect the integrity of the frame. Should it be necessary to move the product, please consider the following:
  1. Force to be evenly spaced around the frame to lift the product off the ground
  2. The product must be carried horizontally
  3. Use caution whilst moving as it could bend the product frame.
- Users should be familiar with the assembly manual. This manual contains assembly guidance; selected precautionary measures as well as recommendations for servicing and maintenance of the product, in order to ensure a secured and fun use of the product.
- It is the responsibility of the owner or the supervisor to guarantee that all users of the product are informed sufficiently of all warning references and safety instructions.

### For the supervisor

The supervisor's role is to make sure users are aware of all safety precautions and that these precautions are enforced. When a supervisor is not available, the product may be disassembled or covered to limit access.

- The product can be only used if it is in good condition, worn or damaged parts should be replaced.
- Objects, which could be dangerous to the user, should be away from the product.
- Avoid unauthorized and unsupervised use of the product.
- Do not use the product under influence of alcohol or drugs (incl. medicines).
- Do not use the product as a jumping platform for other articles.

## Consumer Information Sheet for Playground Surfacing Materials

The US Consumer Product Safety Commission (CPSC) estimates that about 100 000 playground equipment-related injuries resulting from falls to the ground surface are treated annually in US hospital emergency rooms. Injuries involving this hazard pattern tend to be among the most serious of all playground injuries, and have the potential to be fatal, particularly when the injury is to the head. The surface under and around playground equipment can be a major factor in determining the injury-causing potential of a fall. It is self-evident that a fall on to a shock-absorbing surface is less likely to cause a serious injury than a fall onto a hard surface. Playground equipment should never be placed on hard surfaces, such as concrete or asphalt, and while grass may appear to be acceptable, it may quickly turn to hard-packed earth in areas of high traffic. Shredded bark mulch, wood chips, tine sand or the gravel are considered to be acceptable shock absorbing surfaces when installed and maintained at a sufficient depth under and around playground equipment.

Table B.1 lists the maximum height from which a child would not be expected to sustain a life-threatening head injury in a fall on to four different loose-fill surfacing materials if they are installed and maintained at depths of 150 mm, 225 mm and 300 mm.

**TABLE B.1:** Fall height in millimetres from which a life-threatening head injury would not be expected.

TYPE OF MATERIAL	DEPTH OF SURFACING MATERIAL		
	150mm	225mm	300mm
Double Shredded Bark Mulch	1800	3000	3300
Wood Chips	1800	2100	3600
Fine Sand	1500	1500	2700
Fine Gravel	1800	2100	3000











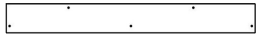
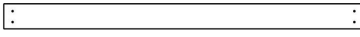
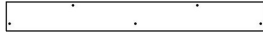
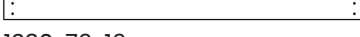
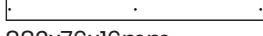
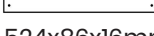
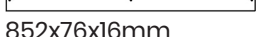

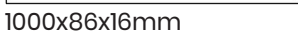

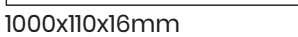

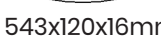
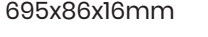
However, it should be recognised that all injuries due to falls cannot be prevented, no matter what surfacing material is used.

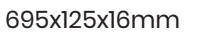
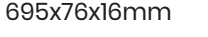
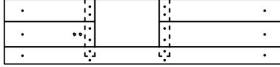

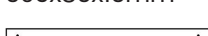
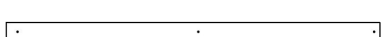

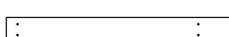

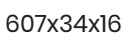



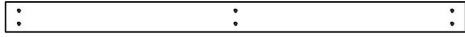

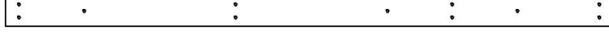
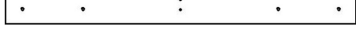
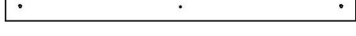
It is recommended that a shock absorbing material extend a minimum of 1800mm in all directions from the perimeter of stationary equipment such as climbing frames and slides. However, because children may deliberately jump from a moving swing, the shock absorbing material should extend in the front and rear of a swing a minimum distance of twice the height of the pivot point measured from a point directly beneath the pivot on the supporting structure.

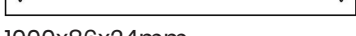
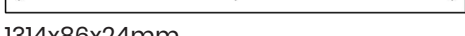
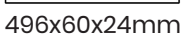
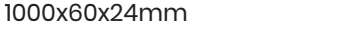
This information is intended to assist in comparing the relative shock-absorbing properties of various materials. No particular material is recommended over another. However, each material is only effective when properly maintained. Materials should be checked periodically and replenished to maintain correct depth as determined necessary for the equipment in question. The choice of a material depends on the type and height of the playground equipment, the availability of the material in a particular area, and its cost.

### III. ASSEMBLY INSTRUCTIONS

#### BOARD LIST

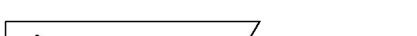
H1 = 1		H21 = 5	
	852x100x16mm		1230x86x16mm
H2 = 1		H22 = 1	
	882x100x16mm		1230x76x16mm
H3 = 1		H23 = 1	
	882x76x16mm		524x86x16mm
H4 = 1		H24 = 4	
	852x76x16mm		905x86x16mm
H5 = 14		H30 = 2	
	1000x86x16mm		227x60x16mm
H6 = 2		H31 = 4	
	1000x110x16mm		251x60x16mm
H7 = 9		H32 = 1	
	728x86x16mm		543x120x16mm
H8 = 12		H34 = 4	
	695x86x16mm		110x86x16mm
H9 = 1			
	695x125x16mm		
H10 = 2		TA1 = 1	
	695x76x16mm		
H11 = 4			
	260x76x16mm		
H12 = 1			
	695x86x16mm		
H13 = 1			
	1314x86x16mm		
H14 = 1			
	1278x134x16mm		
H15 = 5			
	150x86x16mm		
H16 = 5			
	769x86x16mm		
H17 = 5			
	1314x86x16mm		
H18 = 2			
	395x34x16mm		
H19 = 2			
	607x34x16mm		
H20 = 4			
	952x86x16mm		

F1 = 2	
	1314x86x24mm
F2 = 1	
	1000x86x24mm
F3 = 1	
	1734x86x24mm
F4 = 1	
	1734x86x24mm
F5 = 1	
	1000x86x24mm
F6 = 1	
	1000x86x24mm
F7 = 1	
	1734x86x24mm
F8 = 1	
	1115x86x24mm
F9 = 1	
	1000x86x24mm
F10 = 2	
	1314x86x24mm
F11 = 1	
	496x60x24mm
F12 = 1	
	1000x60x24mm
F13 = 1	
	1115x60x24mm
F14Q = 1	
	952x60x24mm
F15 = 1	
	952x86x24mm
F16 = 2	
	258x86x24mm
F17 = 2	
	330x60x24mm
F18 = 1	
	1173x86x24mm
F19 = 4	
	752x86x24mm
F20 = 2	
	86x24x35mm

F23 = 4   
484x86x24mm

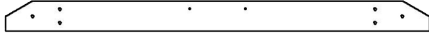
F25 = 2   
1212x85x24mm

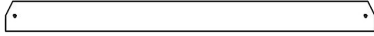
F26 = 1   
1056x86x24mm

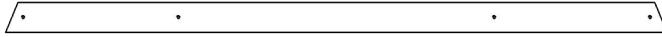
F27 = 1   
1892x86x24mm

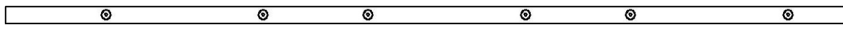
B1 = 1   
2420x134x50mm

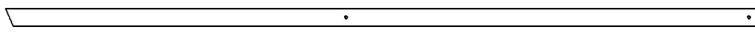
B2 = 2   
2159x76x50mm

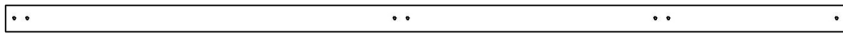
C1A = 1   
2420x76x50mm

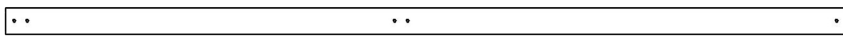
C1B = 1   
2420x76x50mm

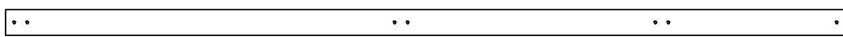
C2 = 2   
2420x76x50mm

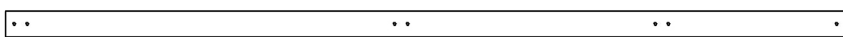
C3 = 2   
2420x76x35mm

C4 = 2   
832x76x35mm

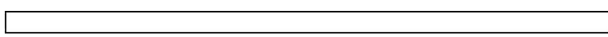
K1 = 1   
1734x60x35mm

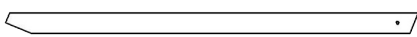
K2 = 2   
1180x60x35mm

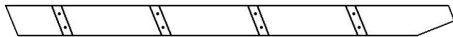
K22 = 1   
1284x86x35mm

K23 = 1   
1284x86x35mm

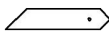
K30 = 8   
300x60x35mm

FP1 = 2   
1480x377x39mm

FP2 = 2   
1480x377x39mm

D1 = 1   
952x134x24mm

D68 = 2   
268x134x24mm

FA26 = 8   
86x76x24mm

T1 = 2   
89x60x24mm

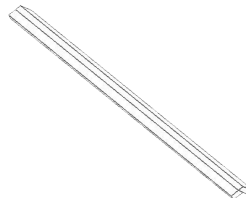
FP3 = 1 

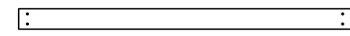
F14S = 1   
952x60x24mm

# PARTS LIST

W12/28  
Washer x 6



W10/18  
Washer x 92



N815  
NUT x 102



BM818  
B-NUT x 19

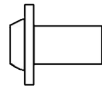

AN8  
A-NUT8 x 6



S315  
Screw x 18



SW16  
Screw x 10

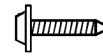

S321  
Screw x 6



SW28  
Screw x 22



S328  
Screw x 4



SW35  
Screw x 401



M821  
Bolt x 12

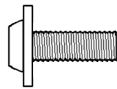

SW40  
Screw x 6



M845  
Bolt x 15

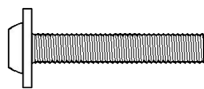

SW50  
Screw x 66

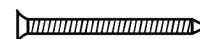

M855  
Bolt x 34

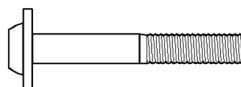

SW60  
Screw x 4



M869  
Bolt x 28

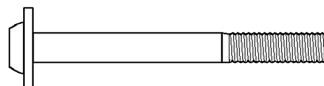

M6SW35  
Screw x 26

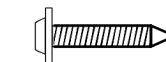

M896  
Bolt x 26

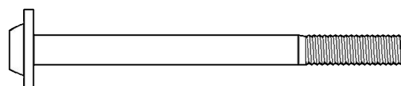

M6SW55  
Screw x 10





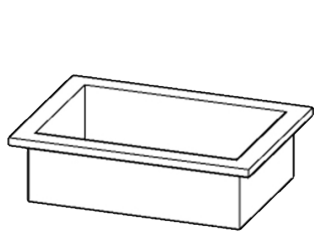

(1) 139007

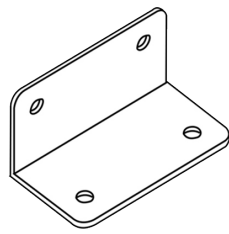

(2) L651003



(1) L651022

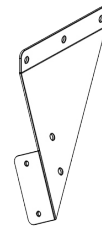

(1) L651023

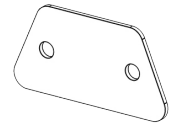

(1) L651024

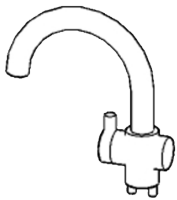

(1) 139008

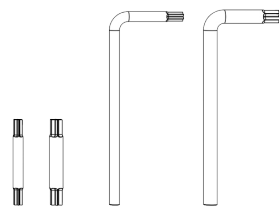

Star Bit (S)  
Star Bit (L)  
Allen Wrench (S)  
Allen Wrench (L)

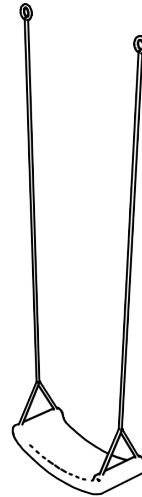

(2) 139002



(6) 650007

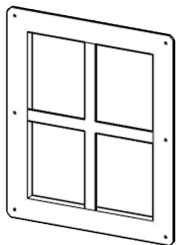

(3) 650051

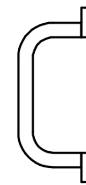

(4) 153003

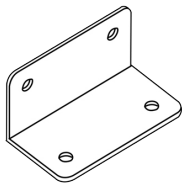

(2) L651015

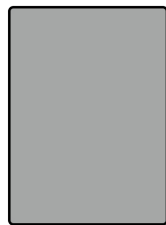

(1) 148001  
530mm x 340mm

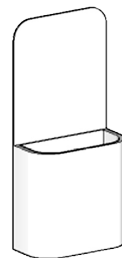

(1) FBH-1

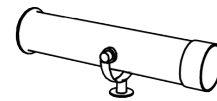

(1) L650008



(7) 139070

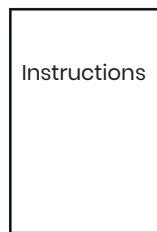

(1) 153090

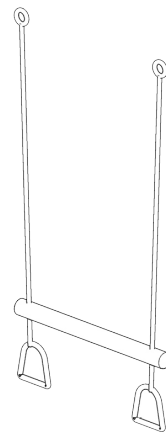

(1) L650050

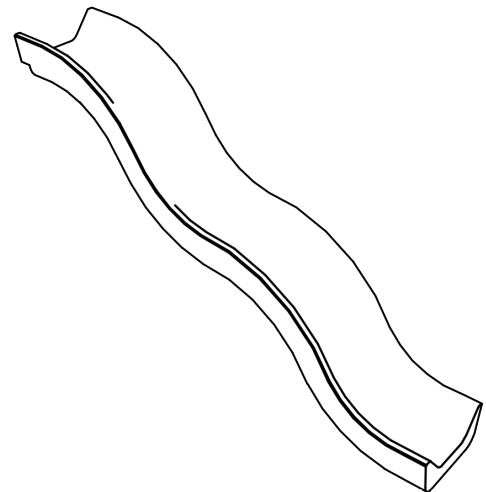

(1) L650001

# STEP 1

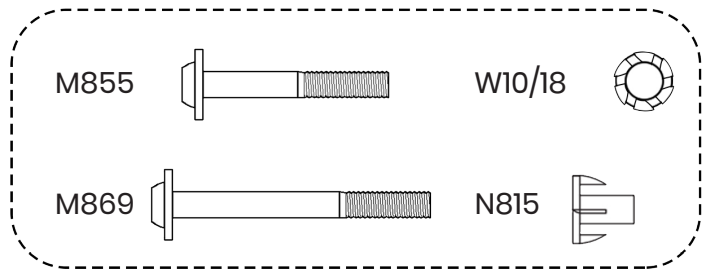
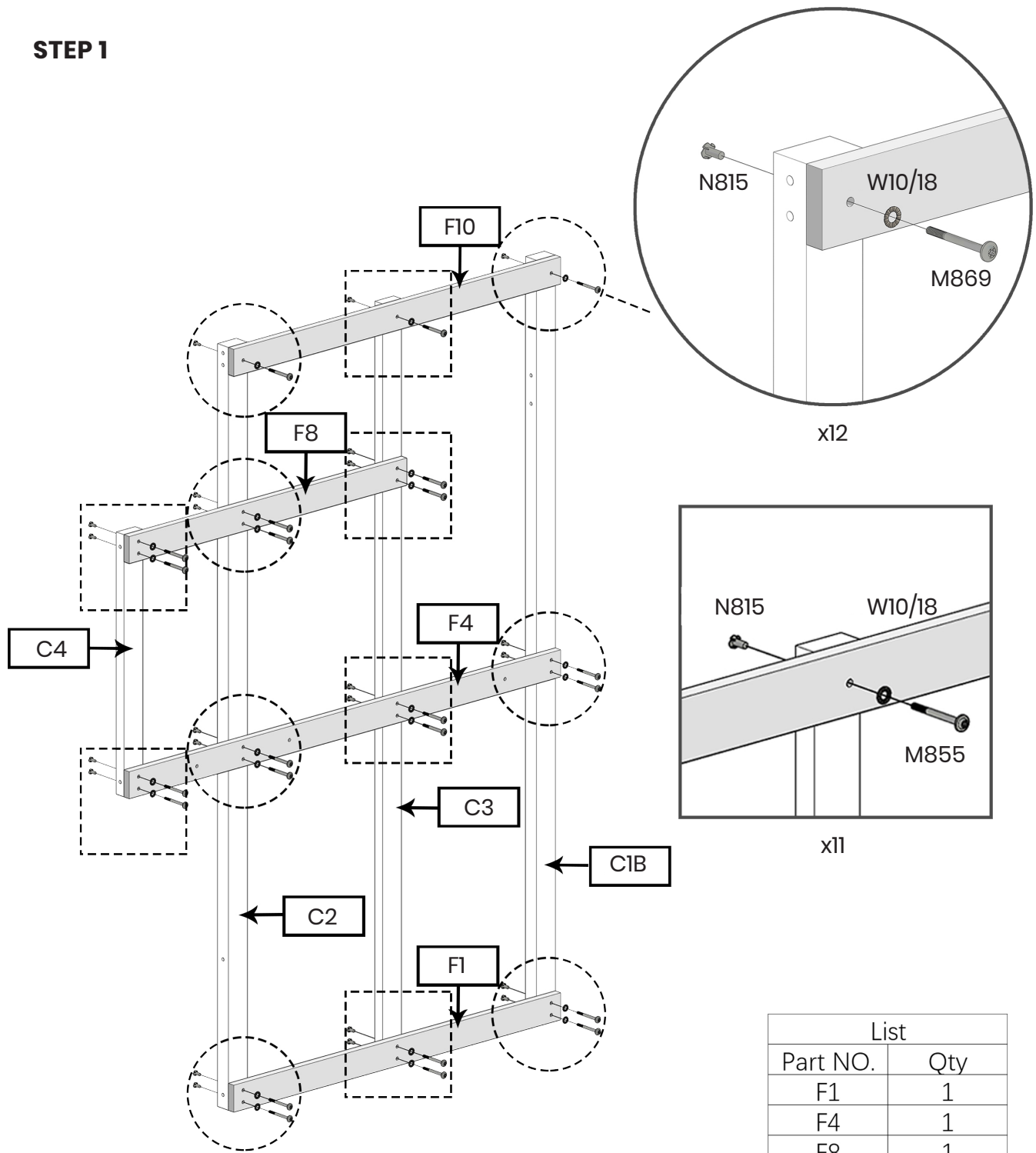

List	
Part NO.	Qty
F1	1
F4	1
F8	1
F10	1
C1B	1
C3	1
C2	1
C4	1
M869	12
W10/18	23
N815	23
M855	11

**STEP 2**

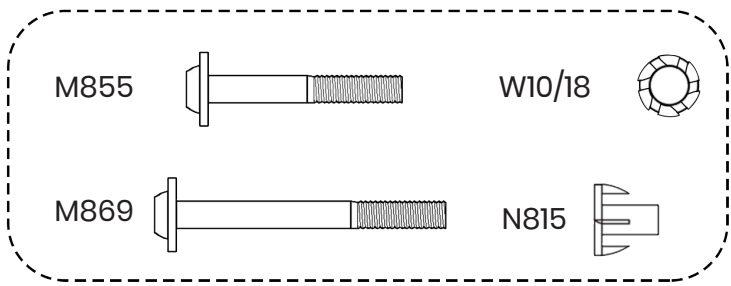
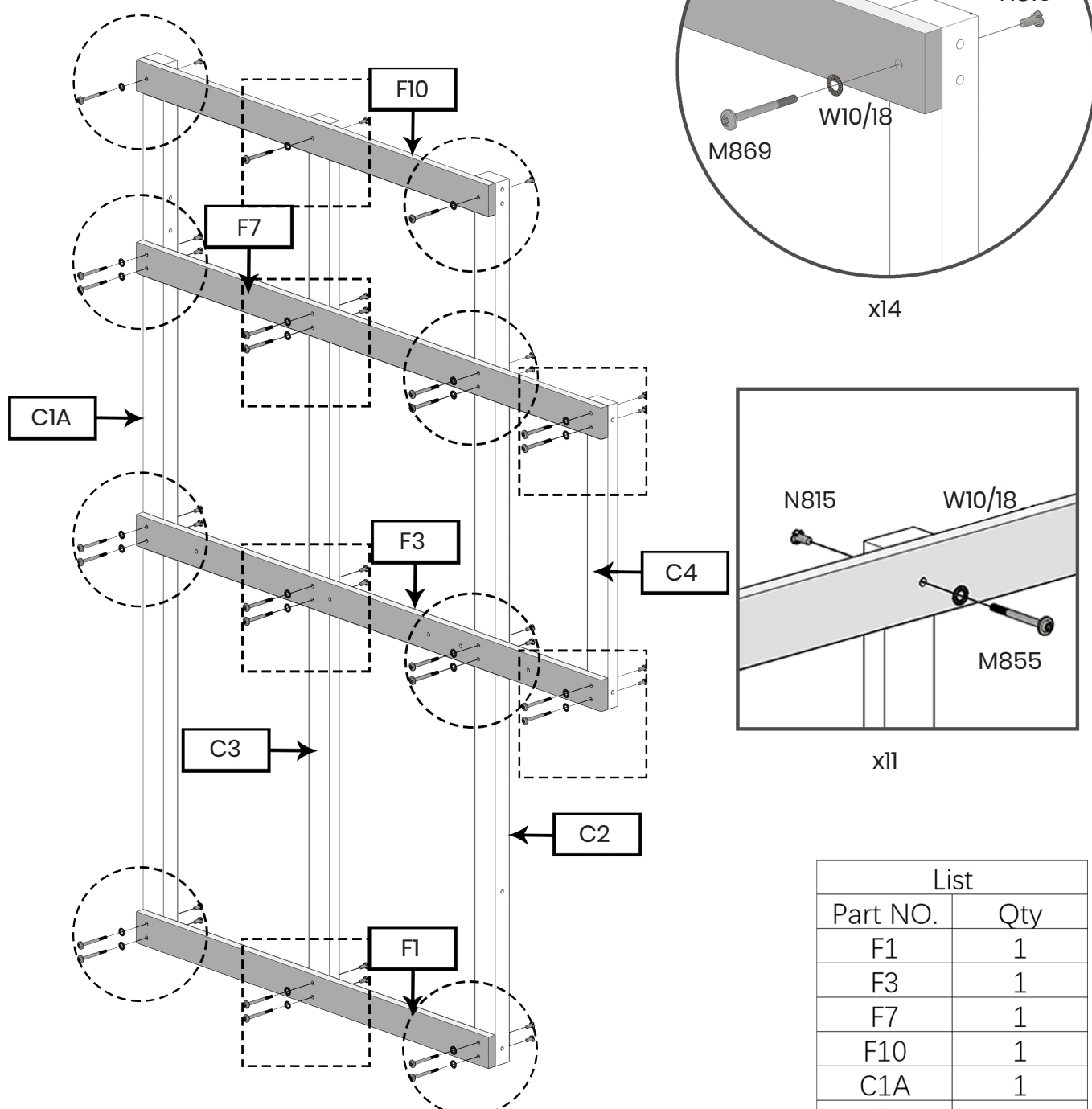

List	
Part NO.	Qty
F1	1
F3	1
F7	1
F10	1
C1A	1
C3	1
C2	1
C4	1
M869	14
W10/18	25
N815	25
M855	11

**STEP 3**

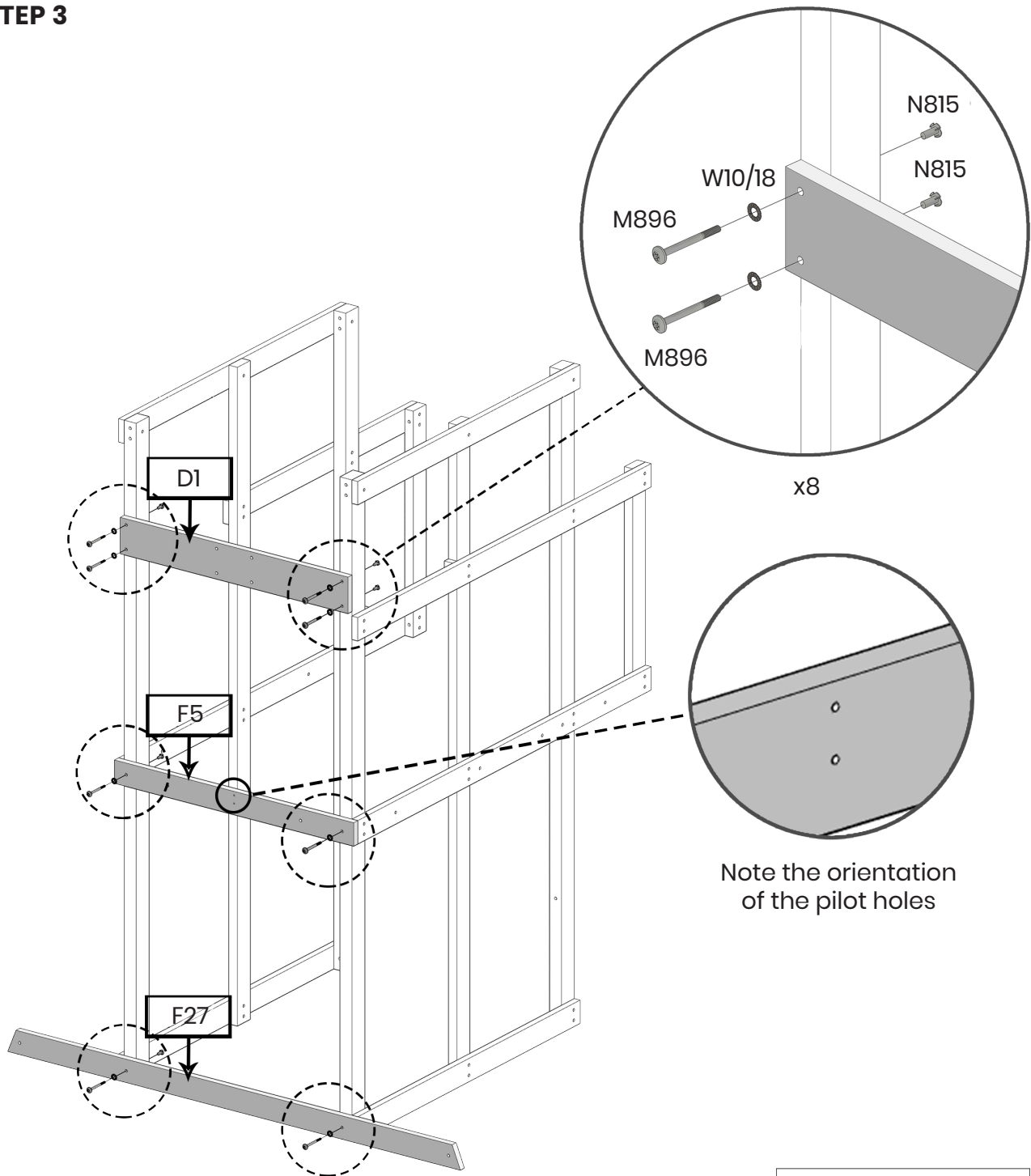

Note the orientation of the pilot holes

List	
Part NO.	Qty
D1	1
F5	1
F27	1
M896	8
W10/18	8
N815	8

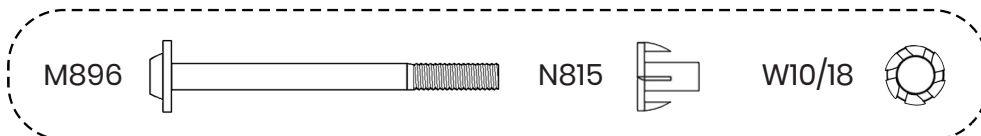

**STEP 4**

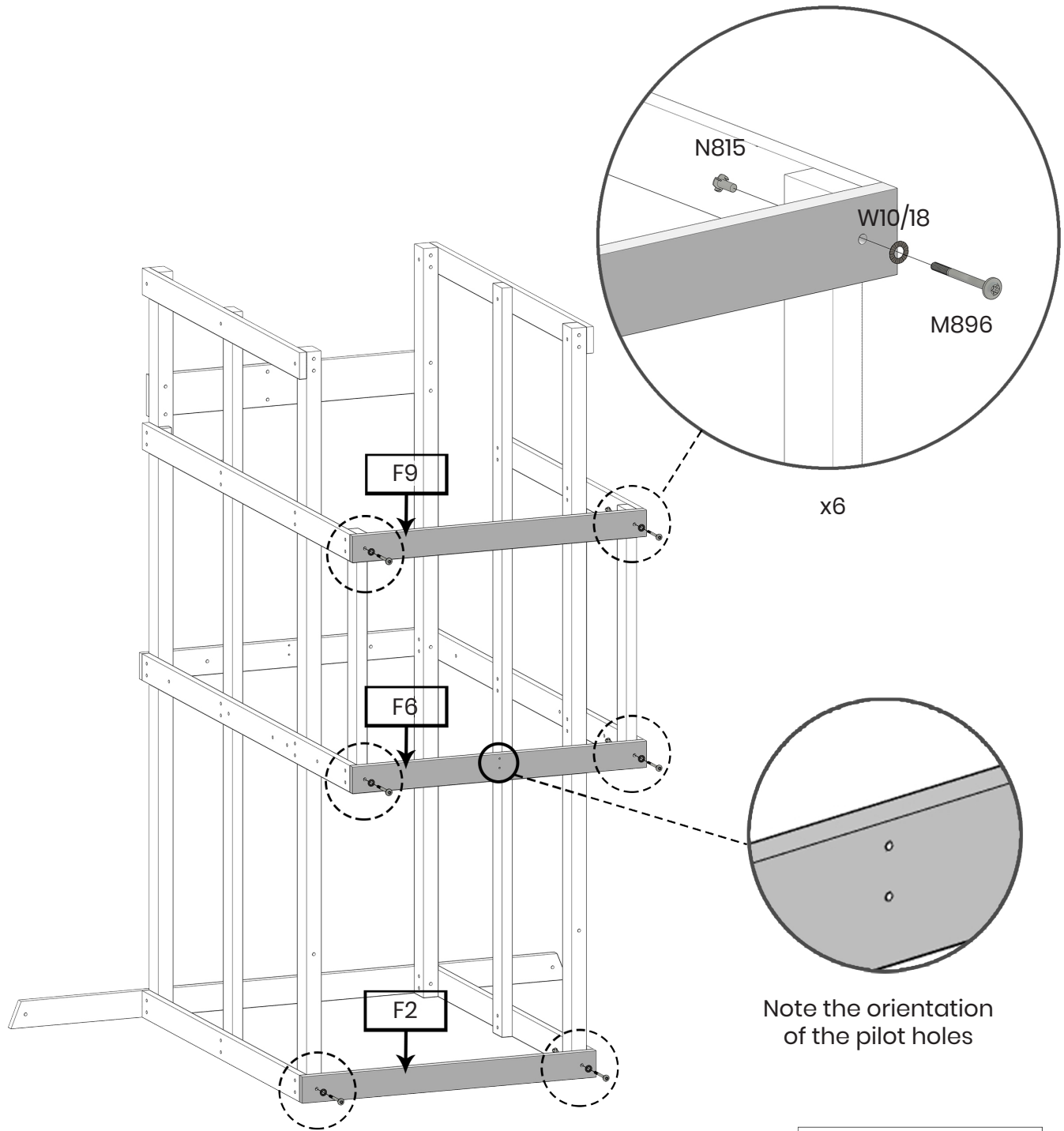

Note the orientation of the pilot holes

List	
Part NO.	Qty
F9	1
F6	1
F2	1
M896	6
W10/18	6
N815	6

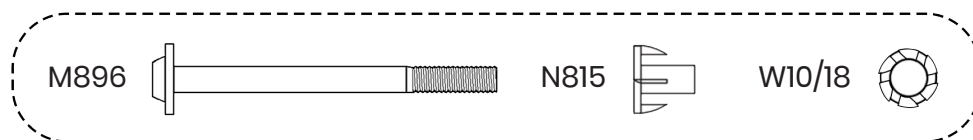

**STEP 5**

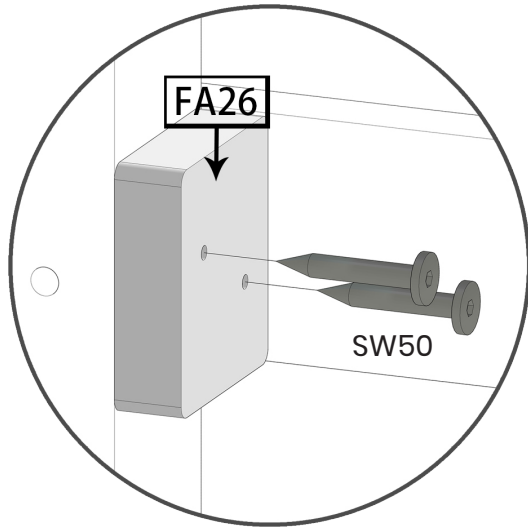

x8

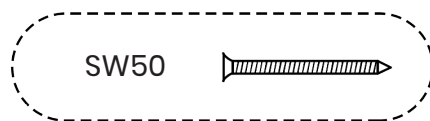
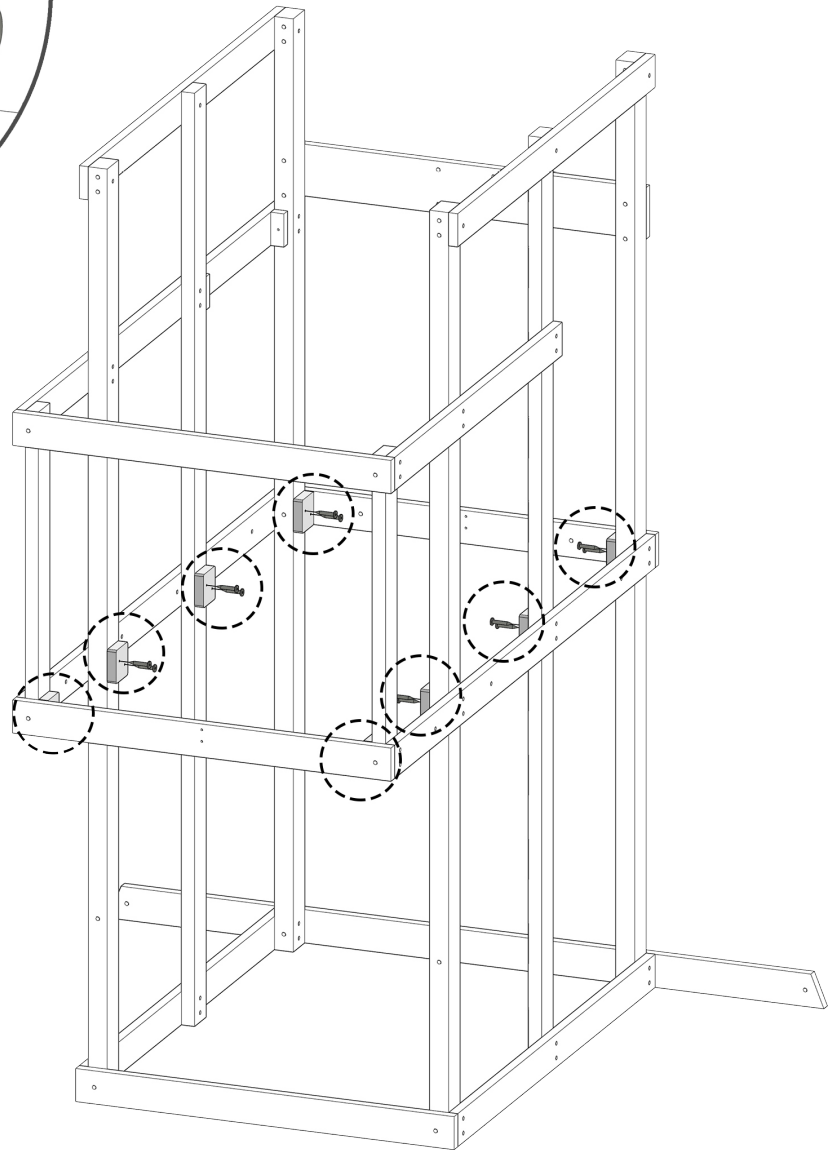

List	
Part NO.	Qty
FA26	8
SW50	16

**STEP 6**

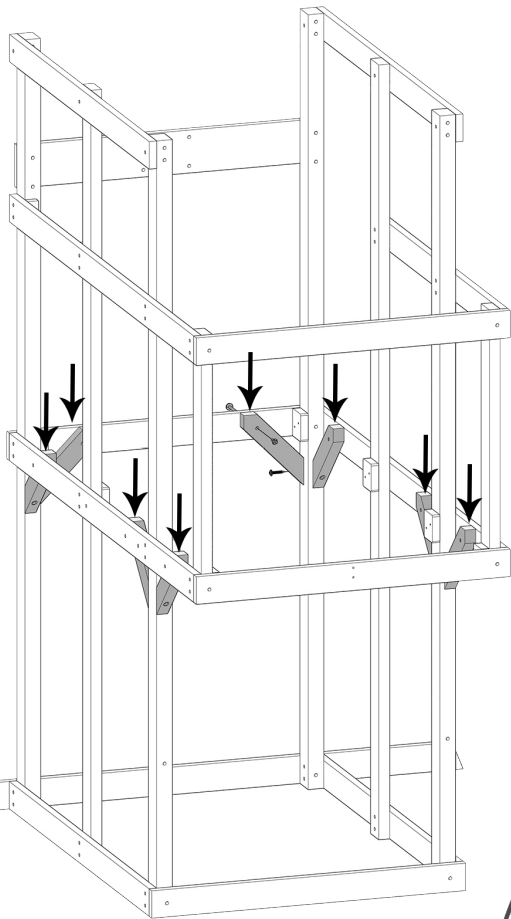

**K30** x8

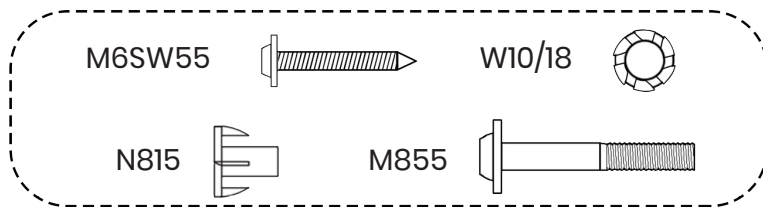
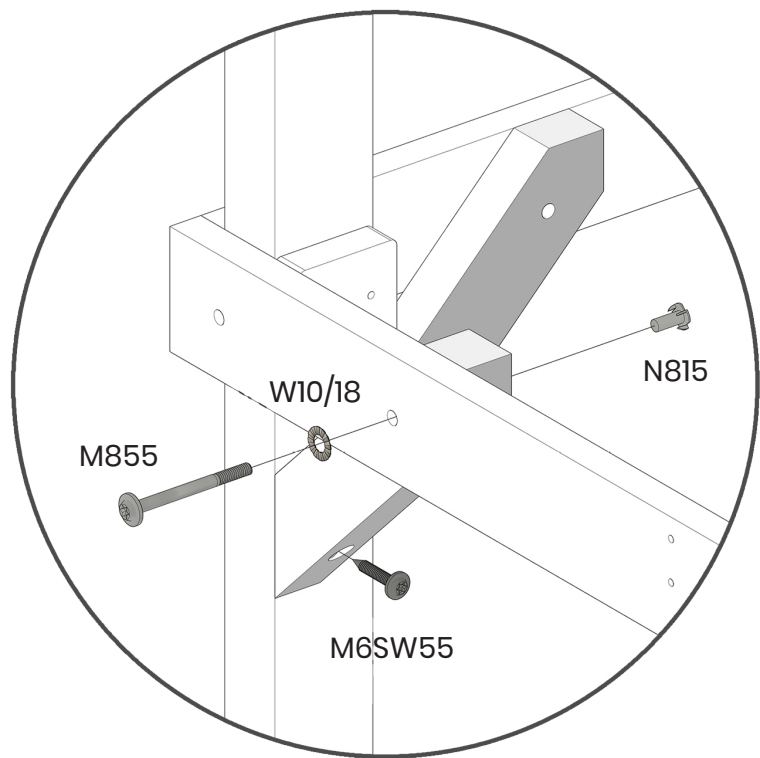

List	
Part NO.	Qty
K30	8
M855	8
W10/18	8
N815	8
M6SW55	8

**STEP 7**

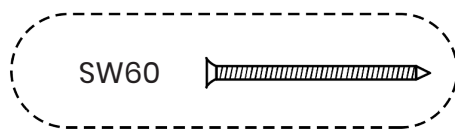
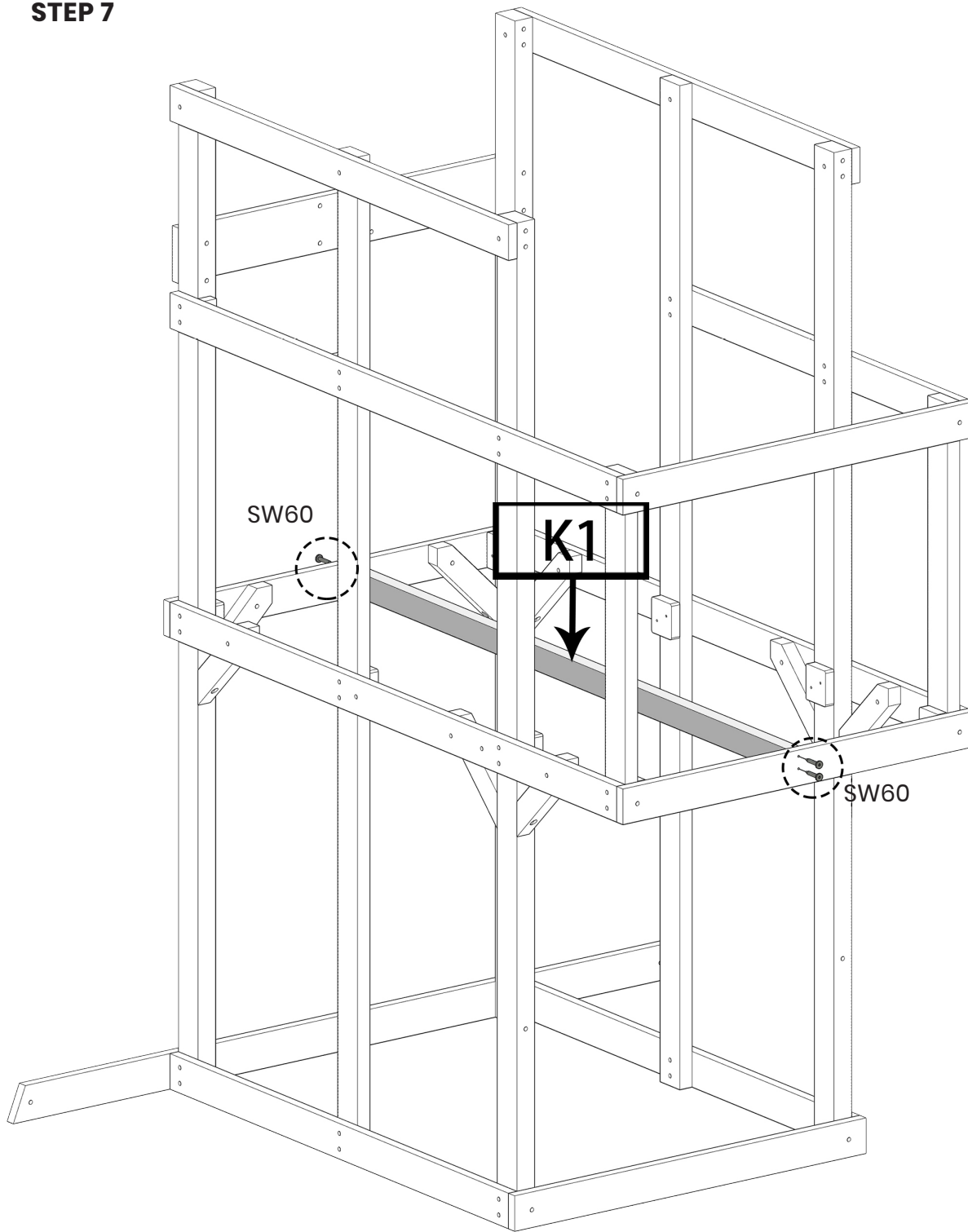

List	
Part NO.	Qty
K1	1
SW60	4



**STEP 8**

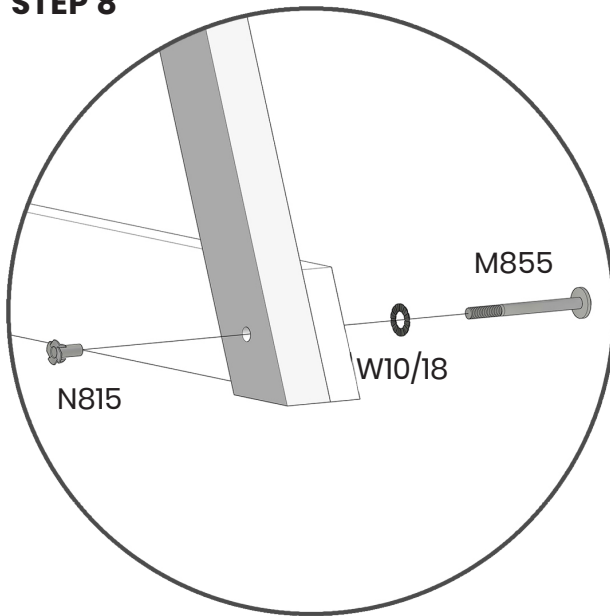

x2

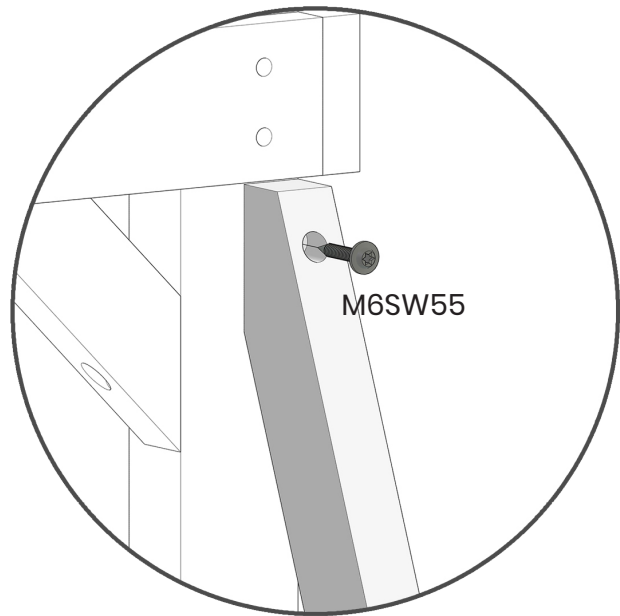

x2

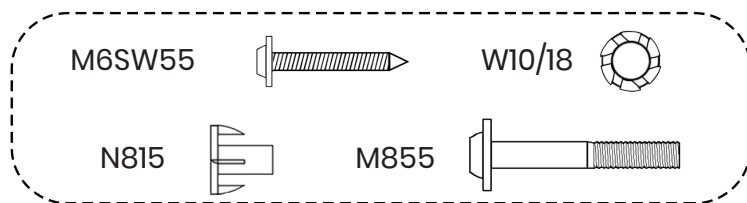
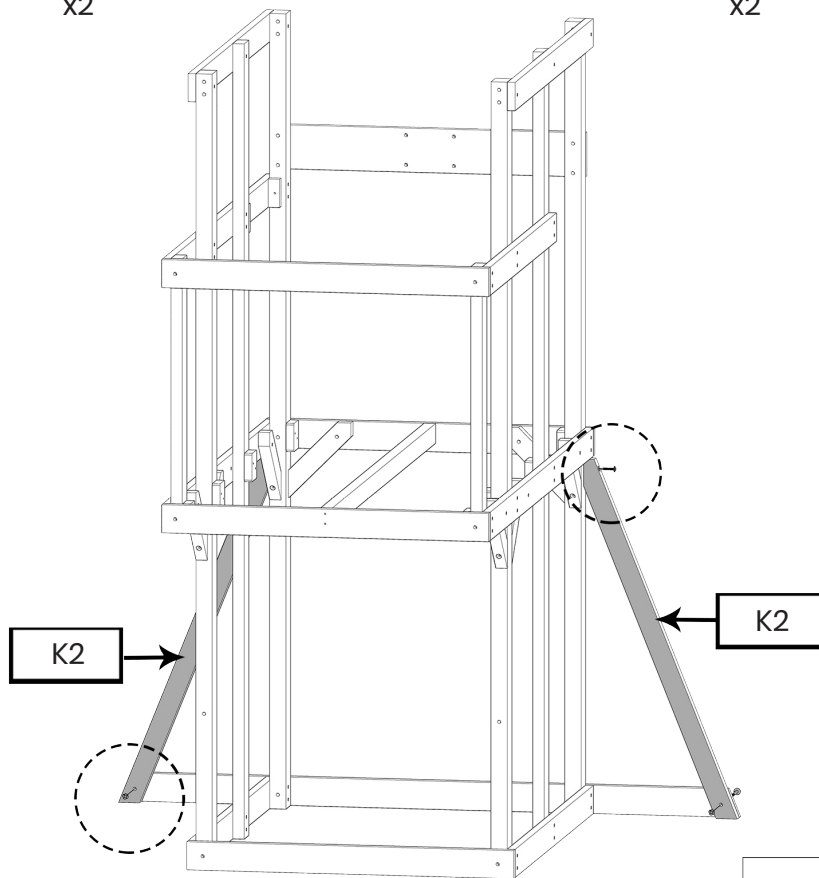

List	
Part NO.	Qty
K2	2
M6SW55	2
M855	2
W10/18	2
N815	2

**STEP 9**

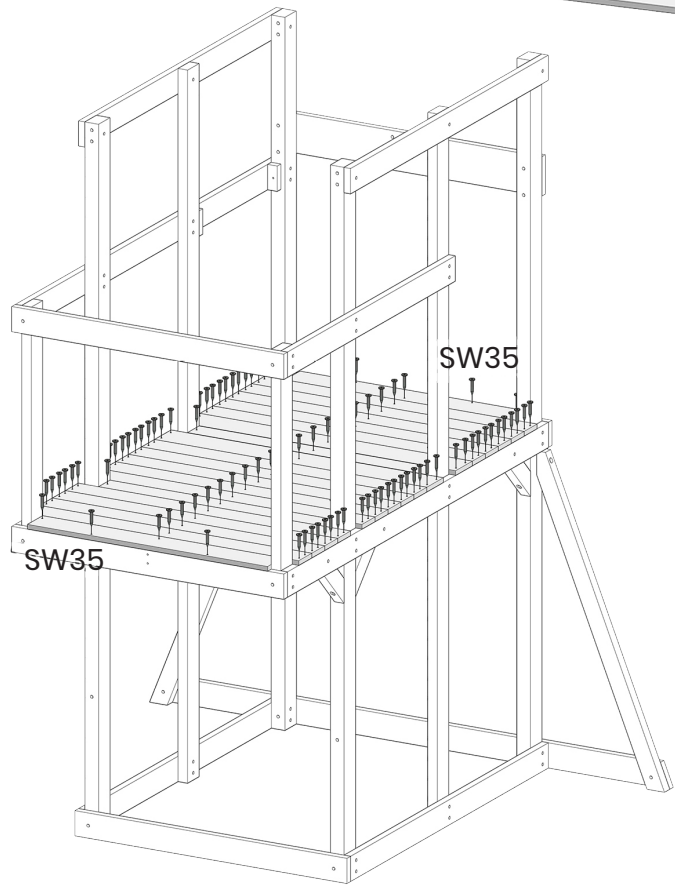
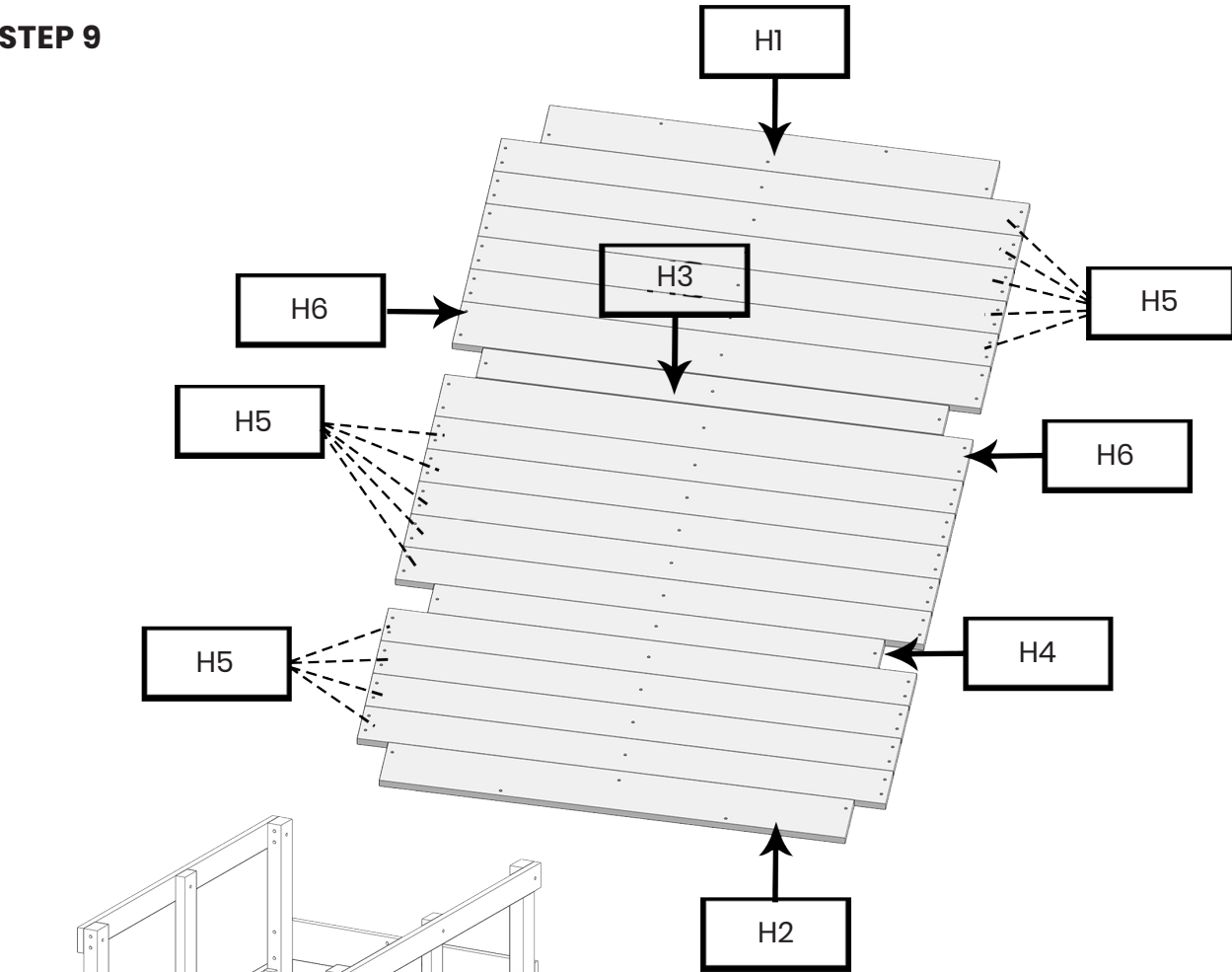

List	
Part NO.	Qty
H1	1
H2	1
H3	1
H4	1
H5	14
H6	2
SW35	96

**STEP 10**

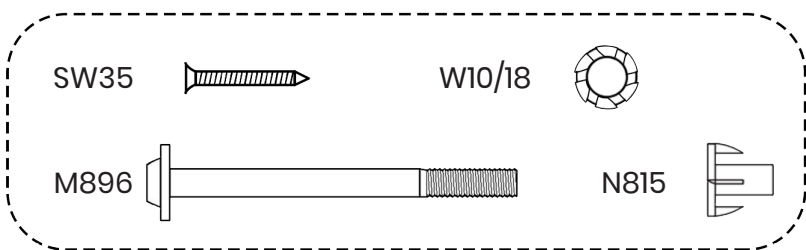
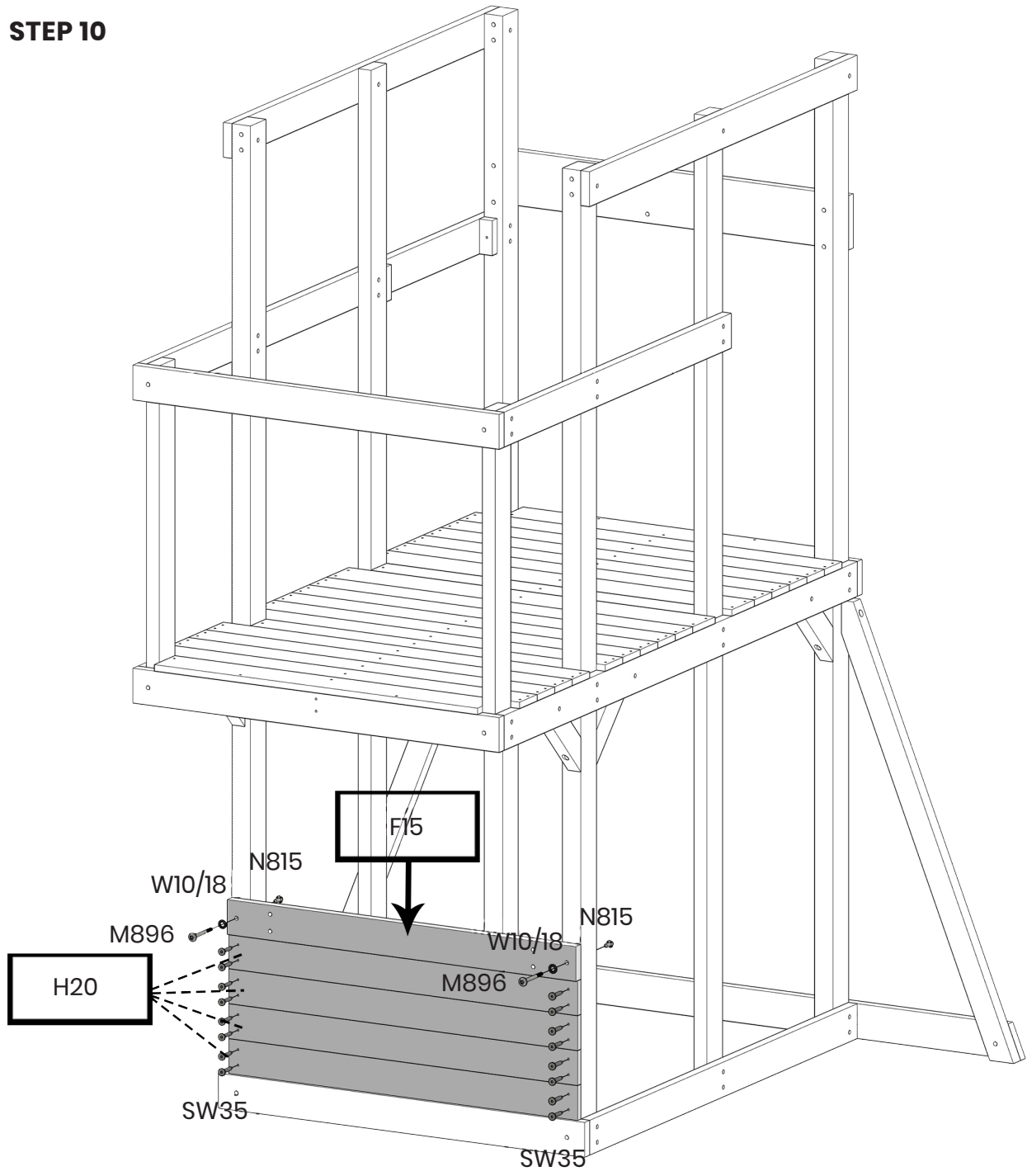

List	
Part NO.	Qty
F15	1
H20	4
SW35	16
M896	2
W10/18	2
N815	2

## STEP 11

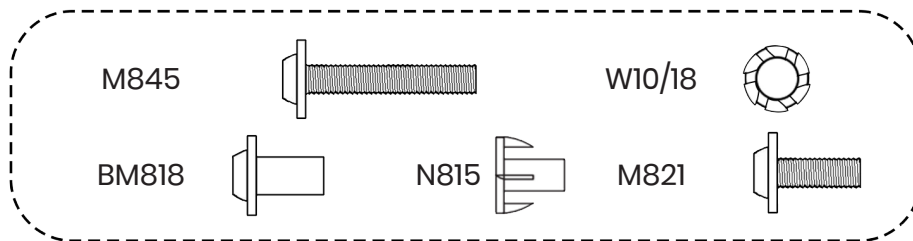
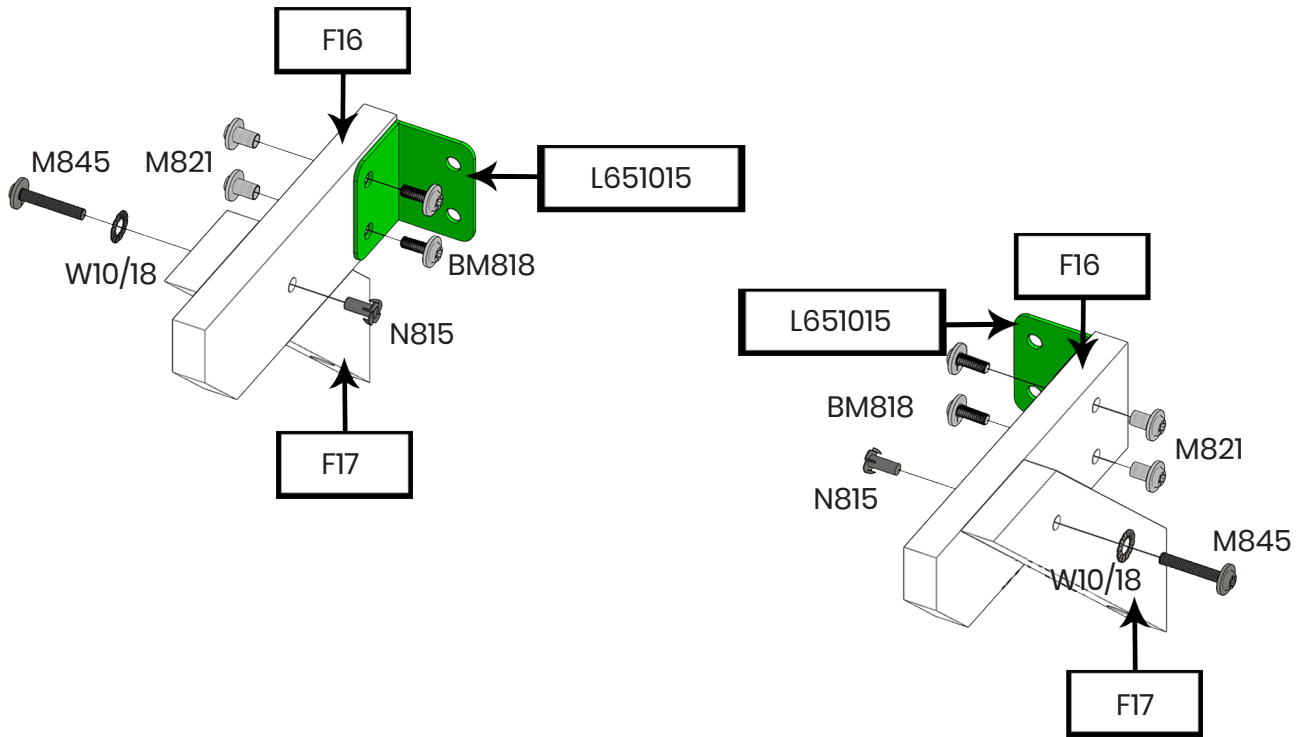

List	
Part NO.	Qty
F16	2
F17	2
M845	2
W10/18	2
N815	2
M821	4
BM818	4
L651015	2

**STEP 12**

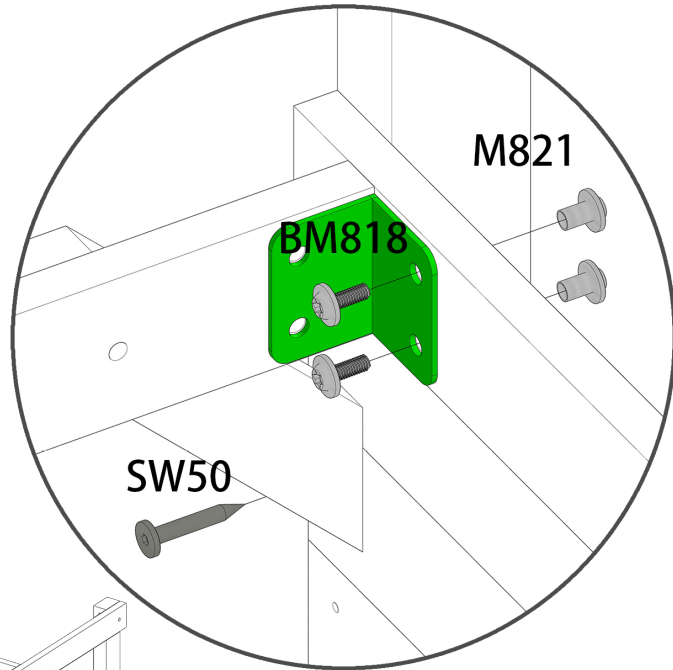

x2

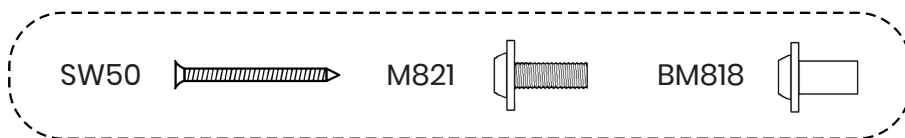
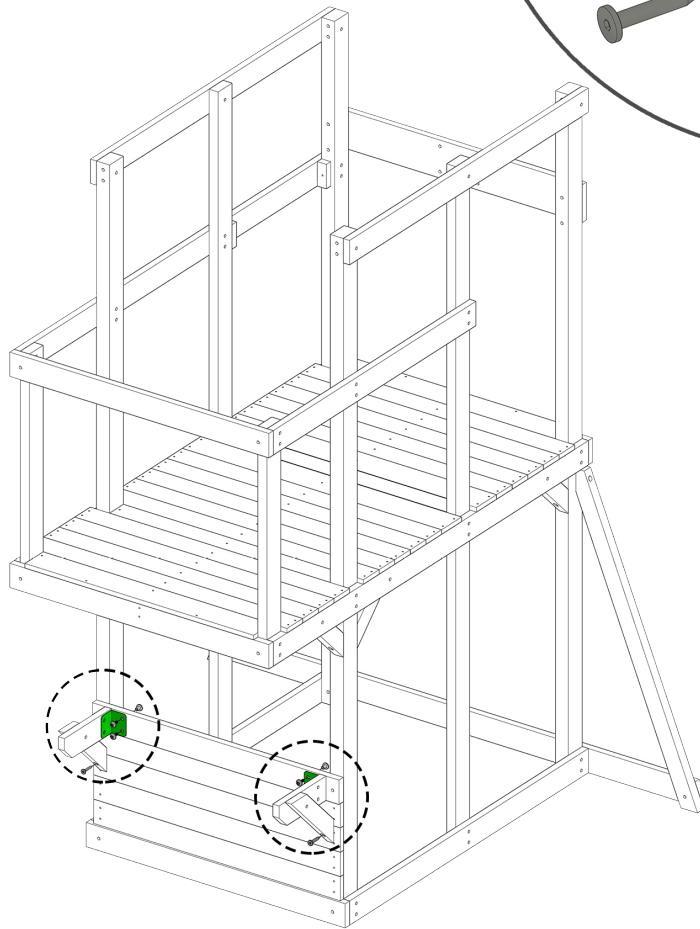

List	
Part NO.	Qty
M821	4
BM818	4
SW50	2

**STEP 13**

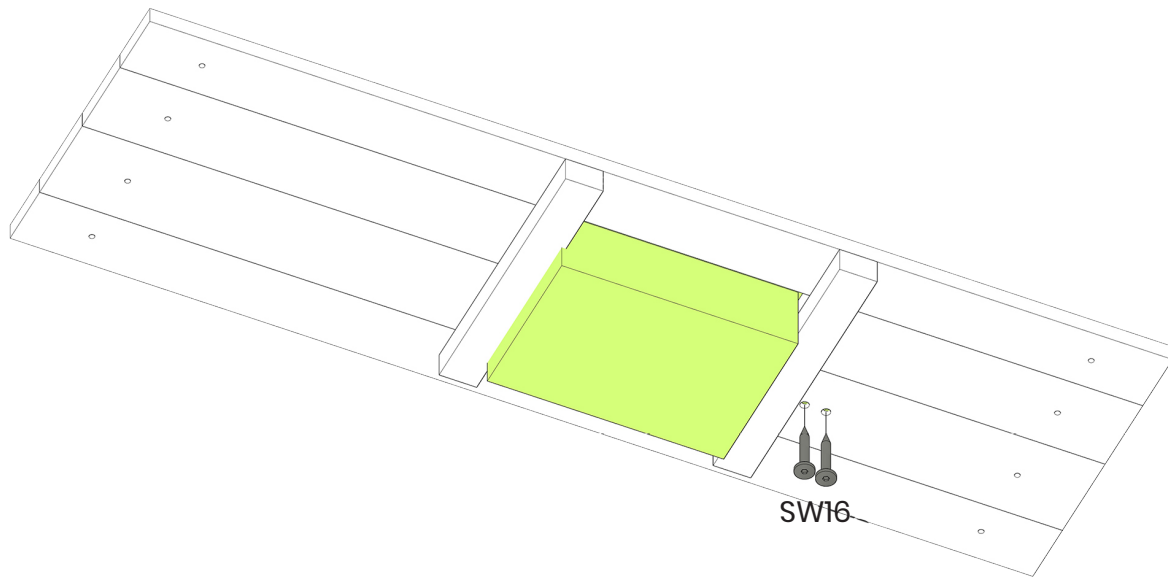
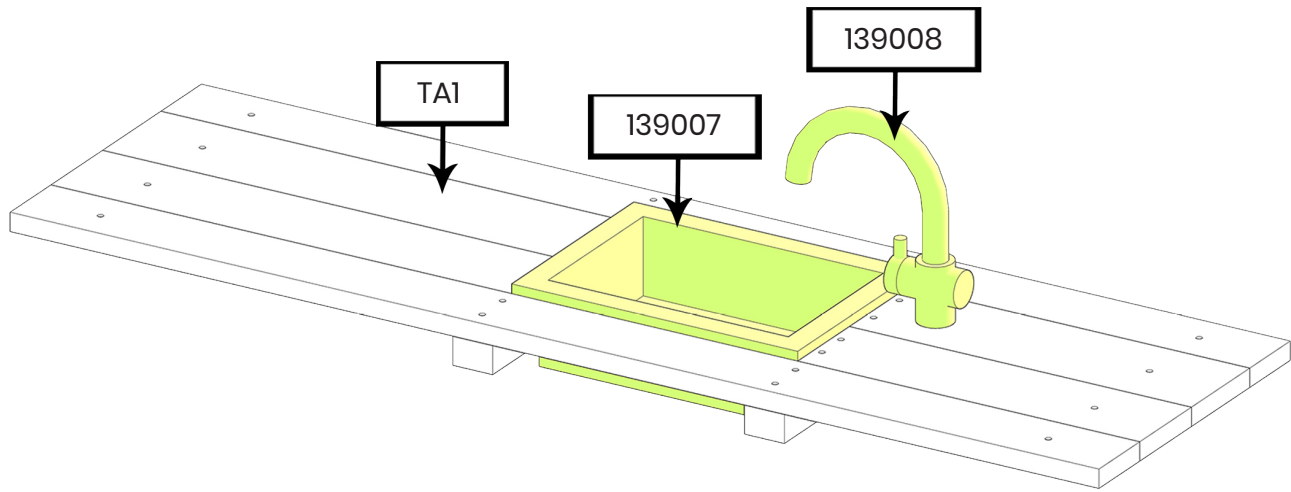

List	
Part NO.	Qty
TA1	1
SW16	2
139007	1
139008	1

**STEP 14**

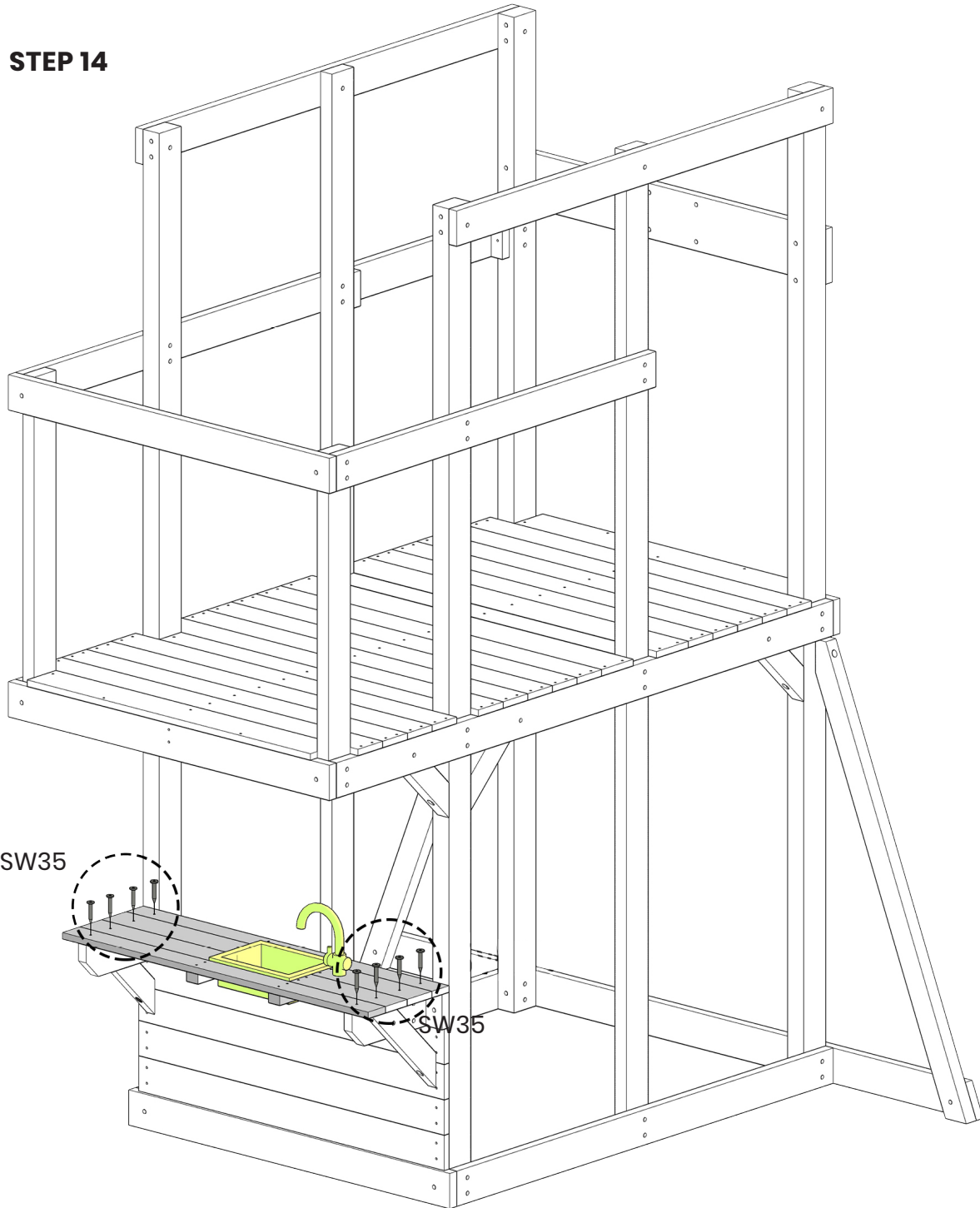

SW35

SW35



List	
Part NO.	Qty
SW35	8

**STEP 15**

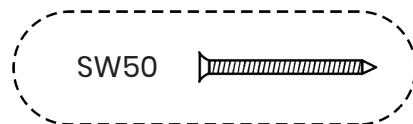
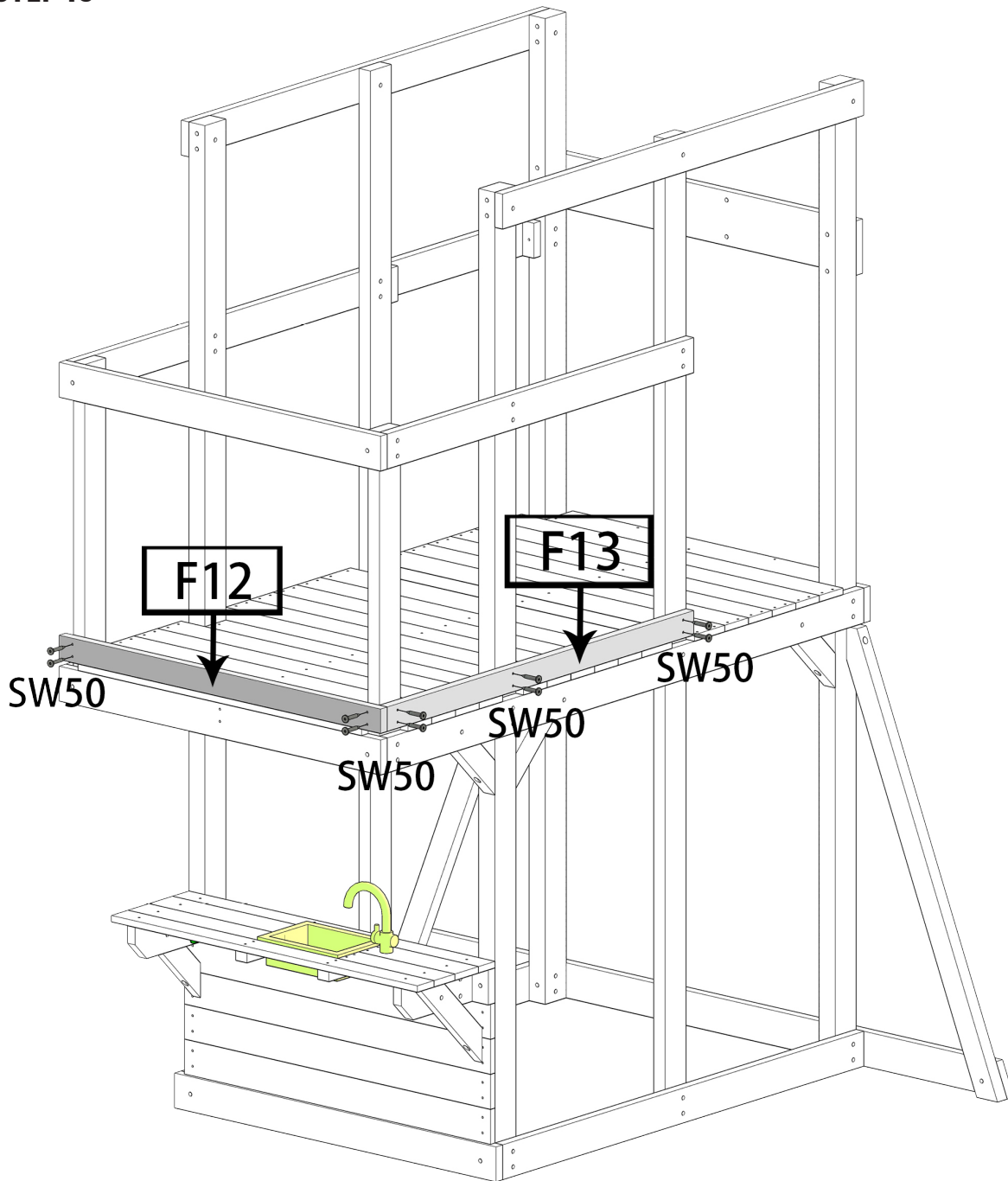

List	
Part NO.	Qty
F12	1
F13	1
SW50	10



**STEP 16**

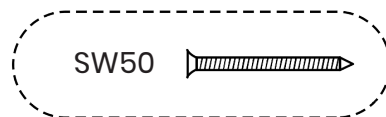
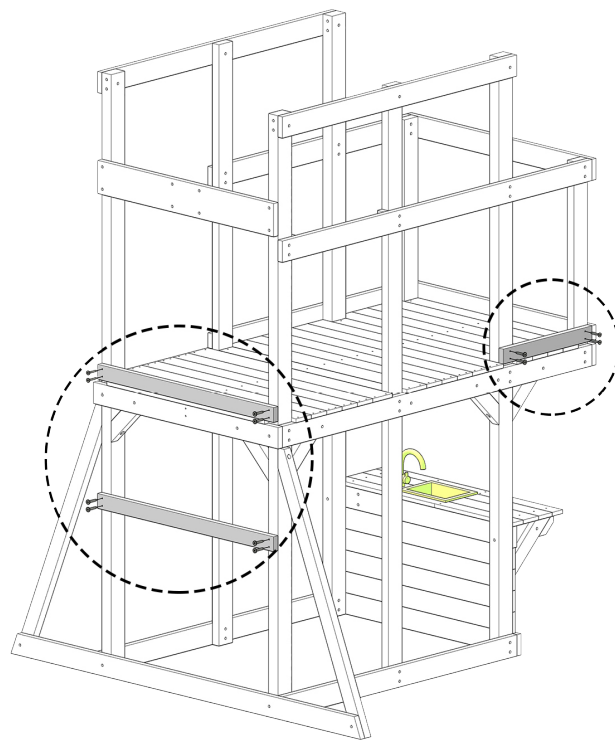
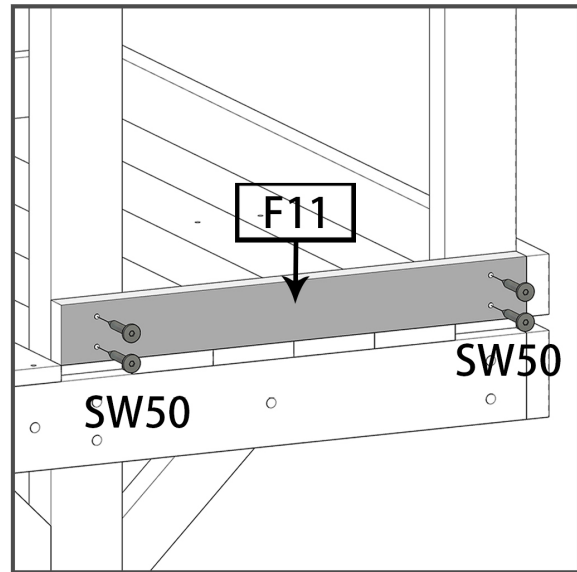
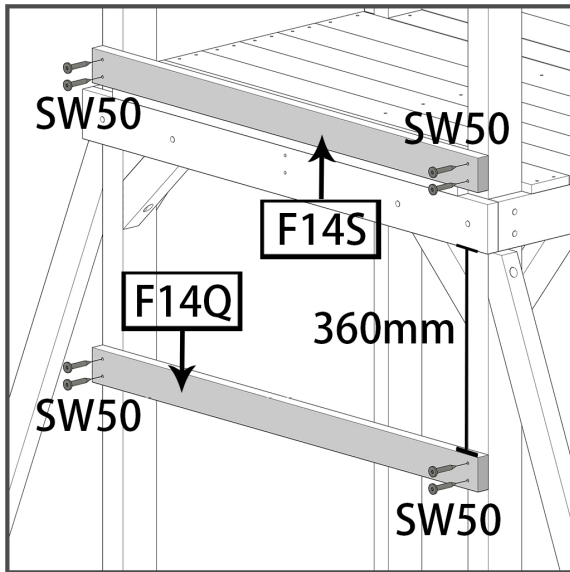

List	
Part NO.	Qty
F11	1
F14S	1
F14Q	1
SW50	12

**STEP 17**

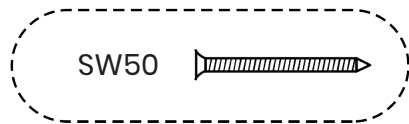
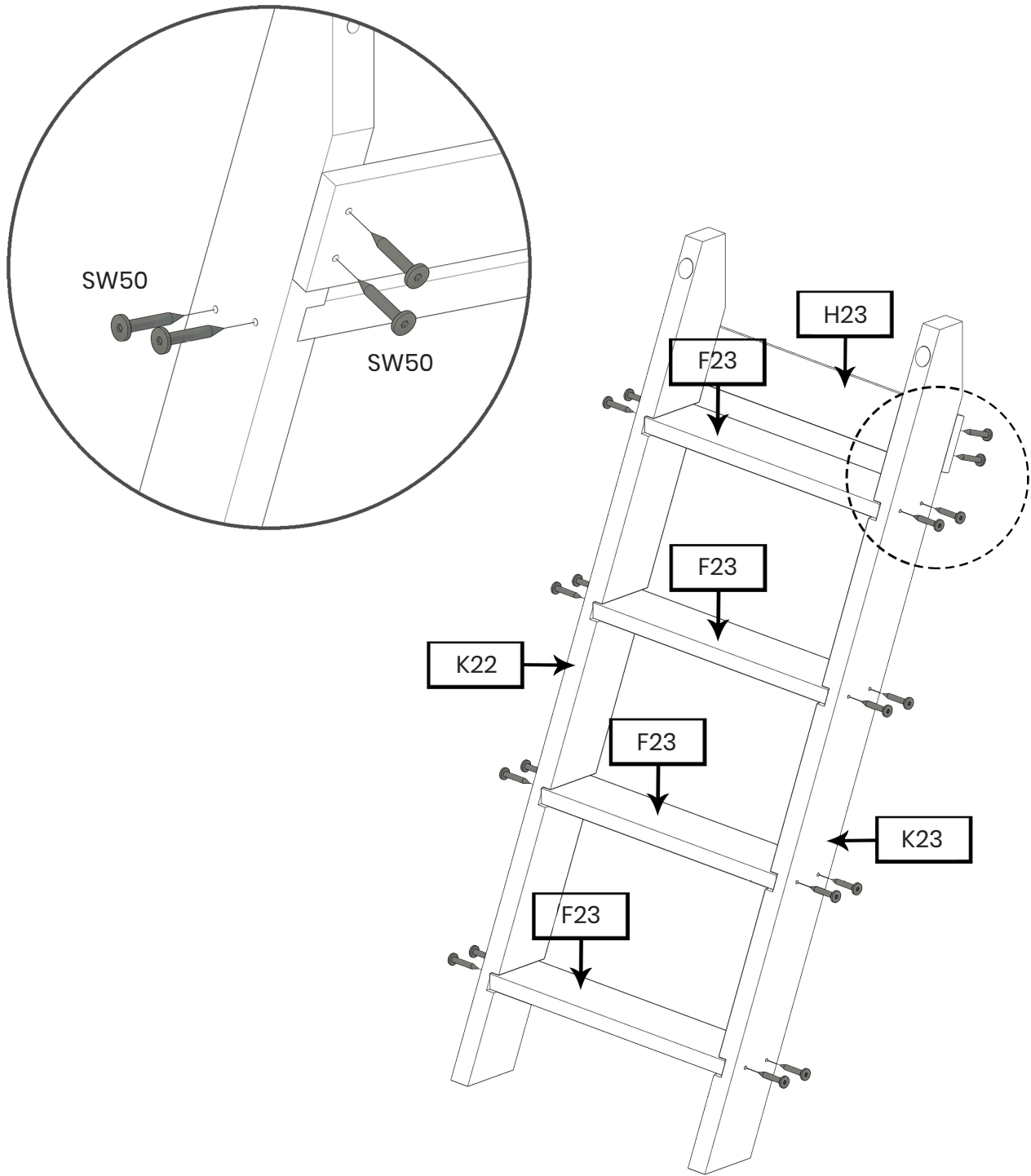

List	
Part NO.	Qty
F23	4
H23	1
K22	1
K23	1
SW50	20

**STEP 18**

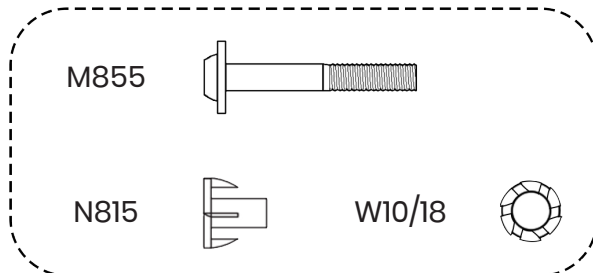
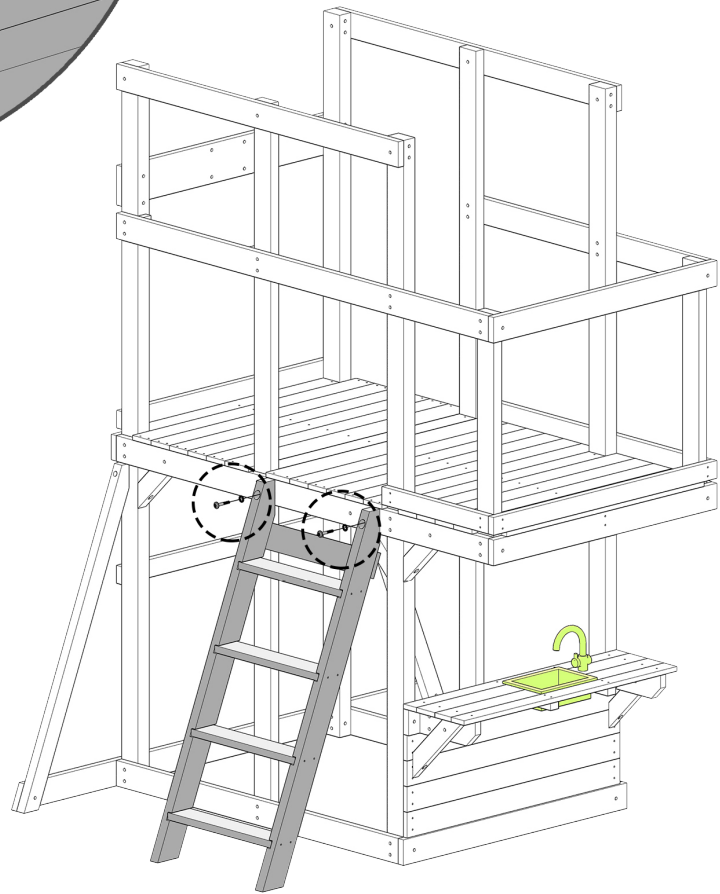
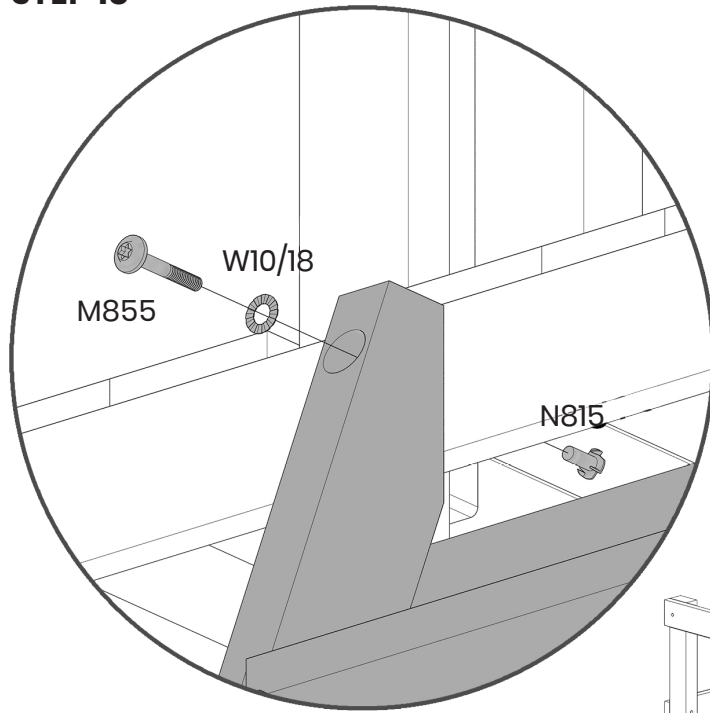

List	
Part NO.	Qty
M855	2
W10/18	2
N815	2

**STEP 19**

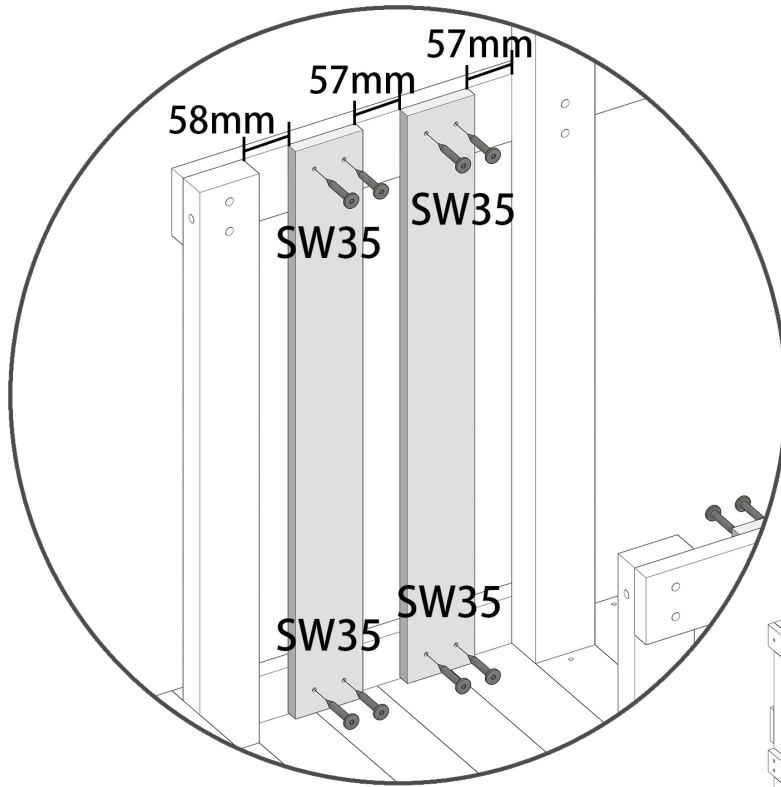

**H7** x4

x2

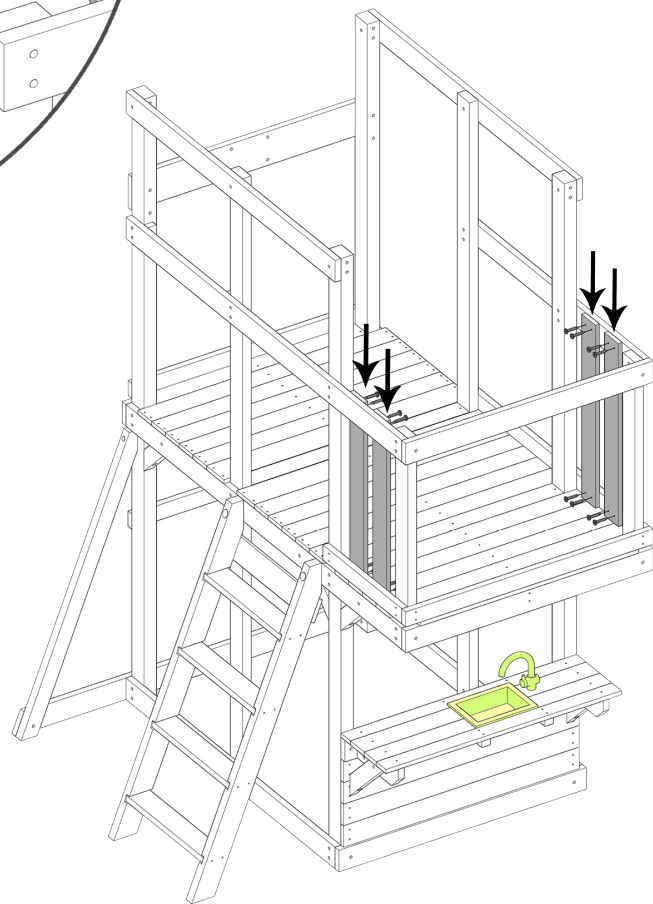

List	
Part NO.	Qty
H7	4
SW35	16

**STEP 20**

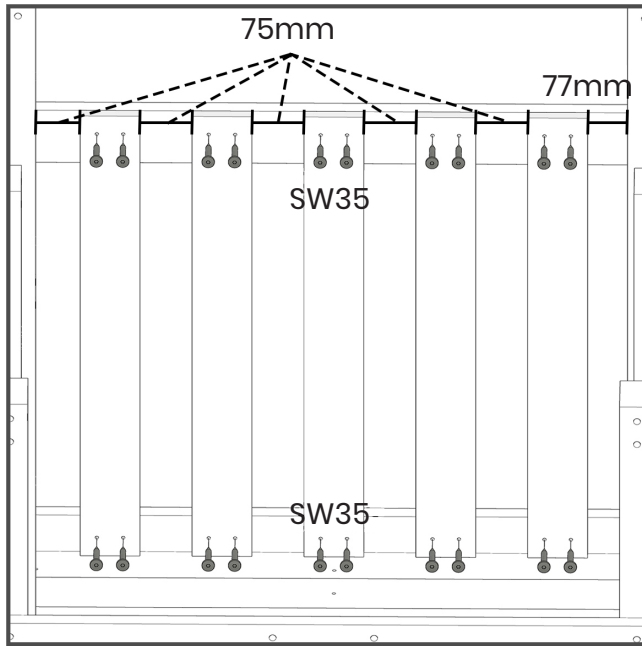

**H7** x5

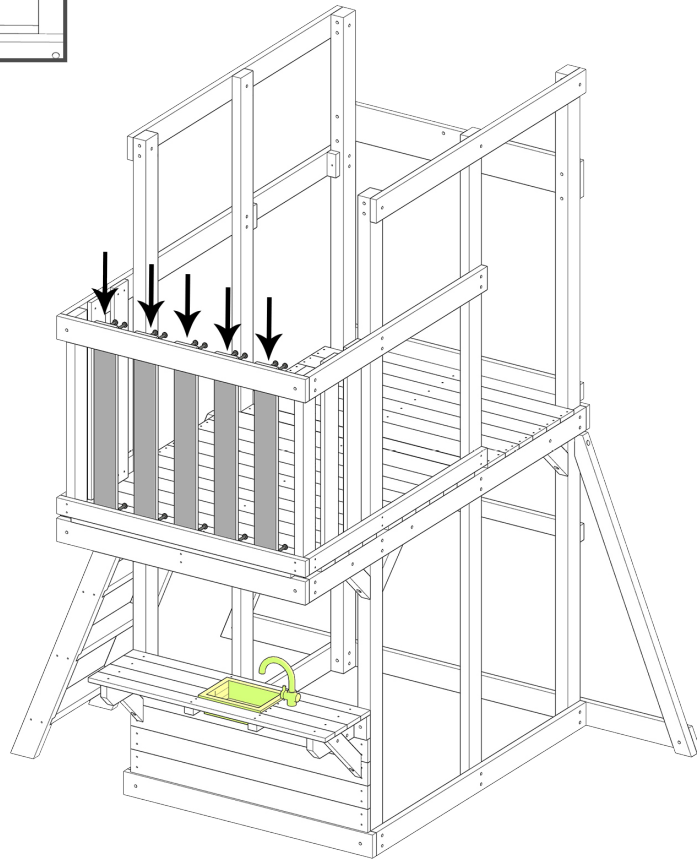

List	
Part NO.	Qty
H7	5
SW35	20

**STEP 21**

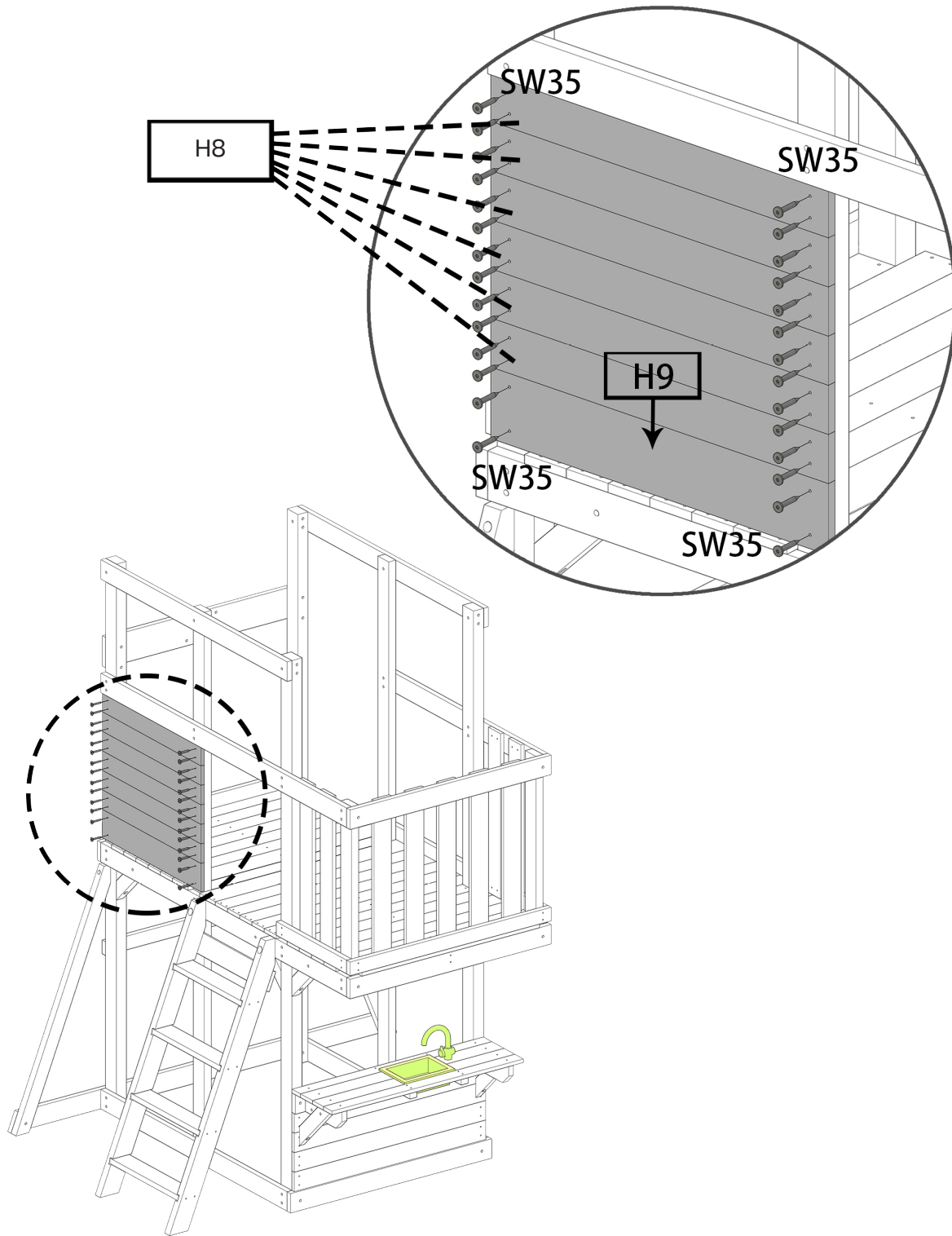

List	
Part NO.	Qty
H8	6
H9	1
SW35	28

**STEP 22**

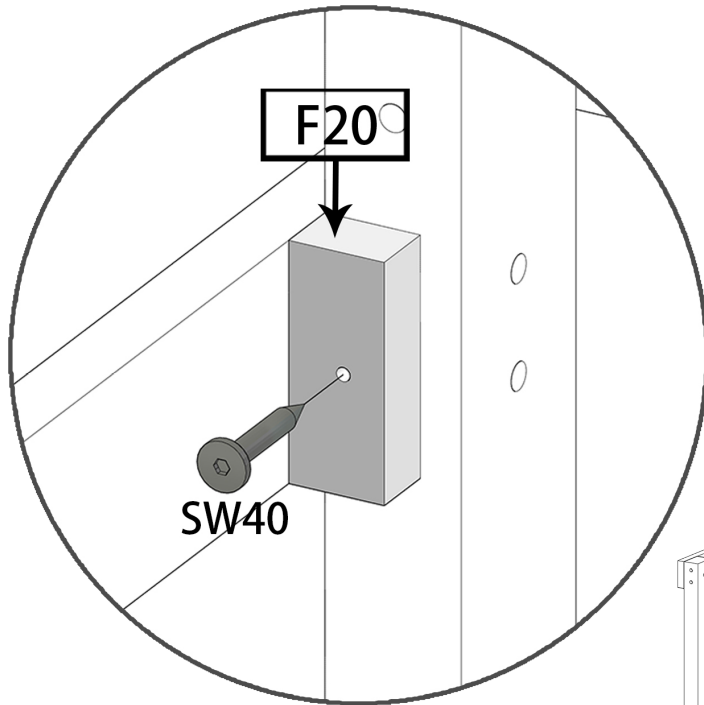

x2

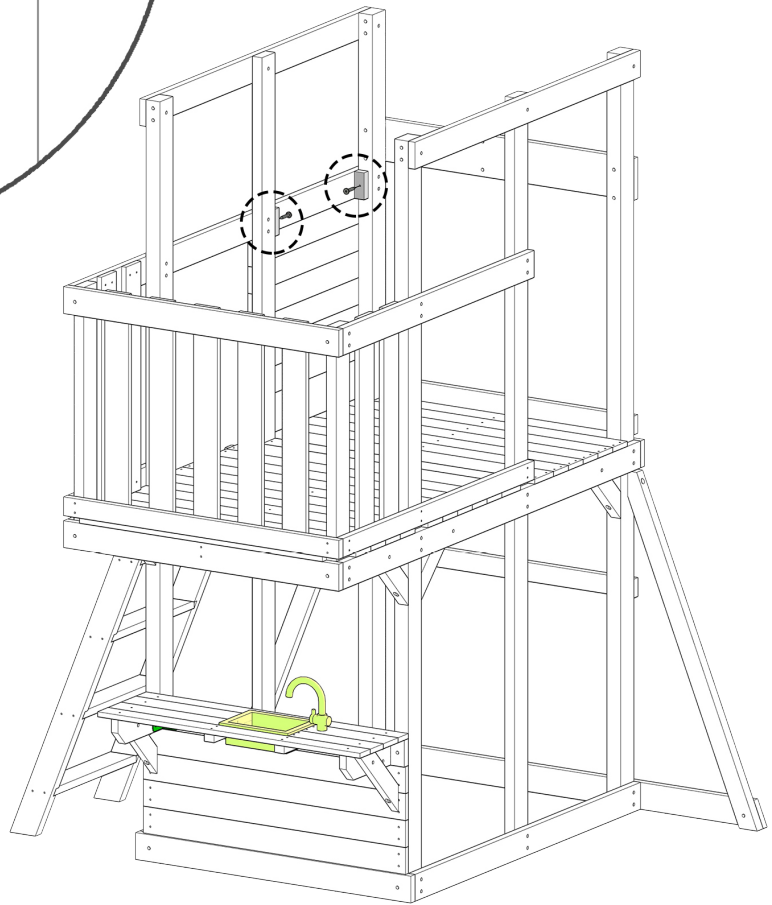

List	
Part NO.	Qty
F20	2
SW40	2

**STEP 23**

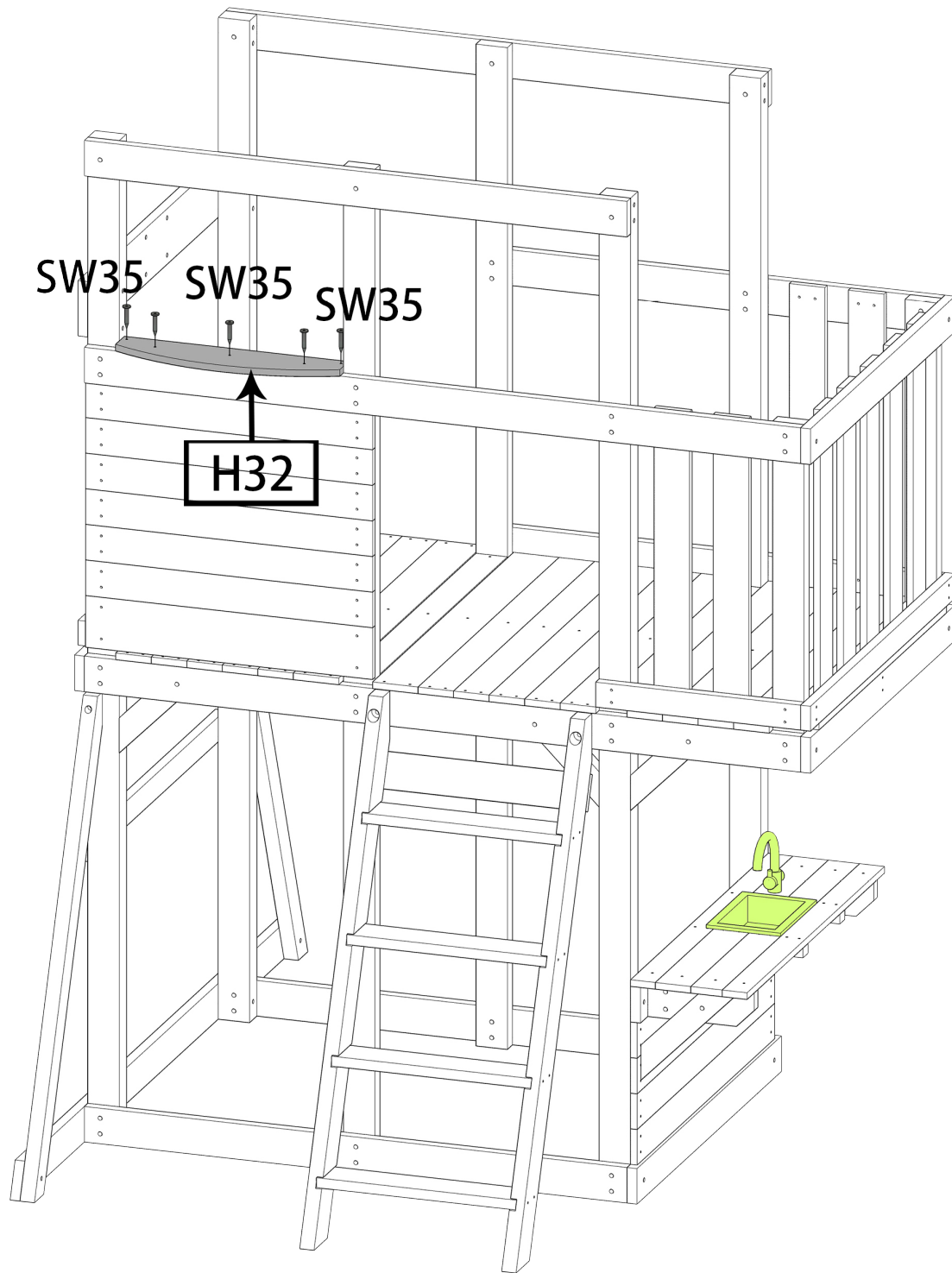

List	
Part NO.	Qty
H32	1
SW35	5



**STEP 24**

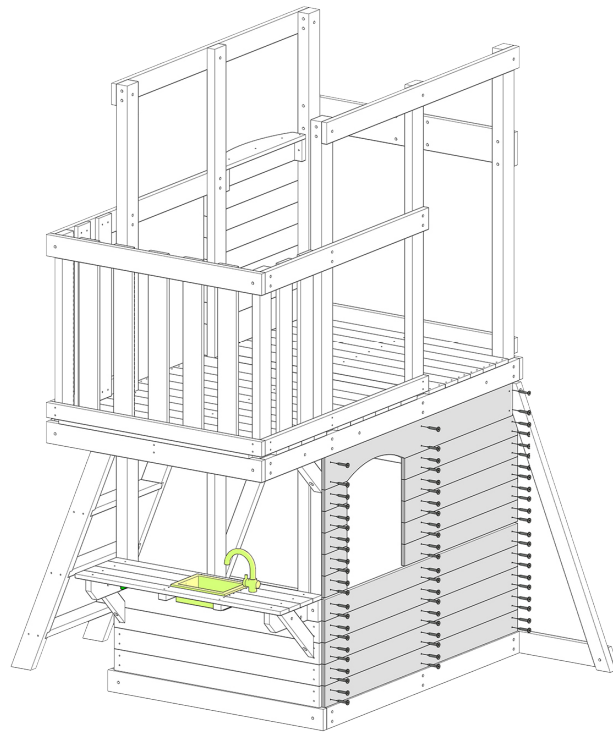
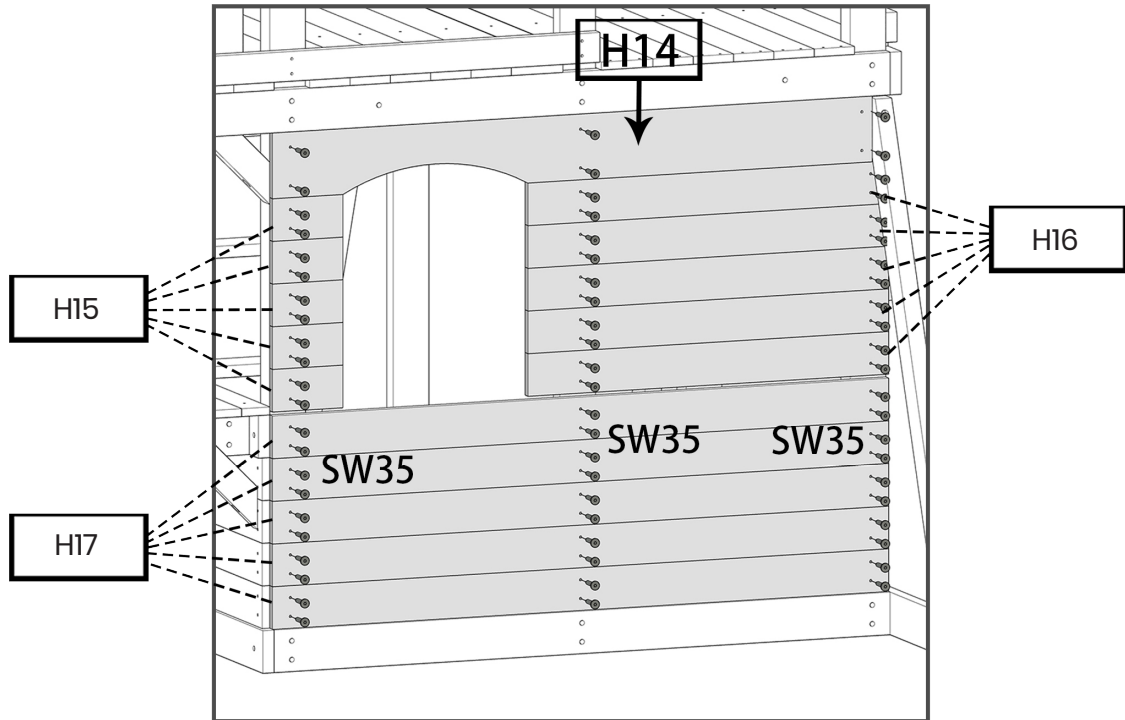

List	
Part NO.	Qty
H14	1
H15	5
H16	5
H17	5
SW35	66

**STEP 25**

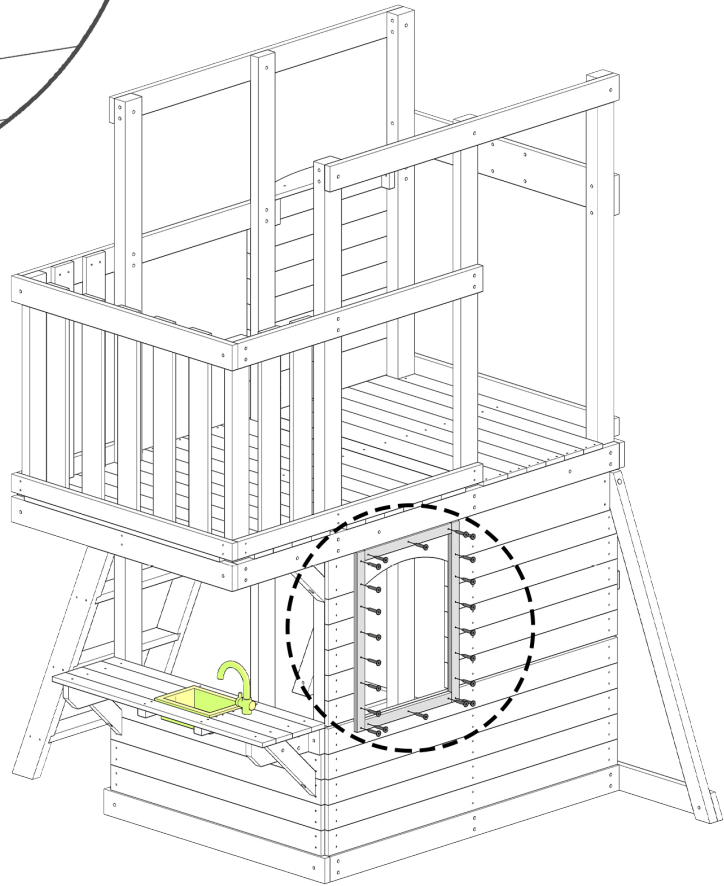
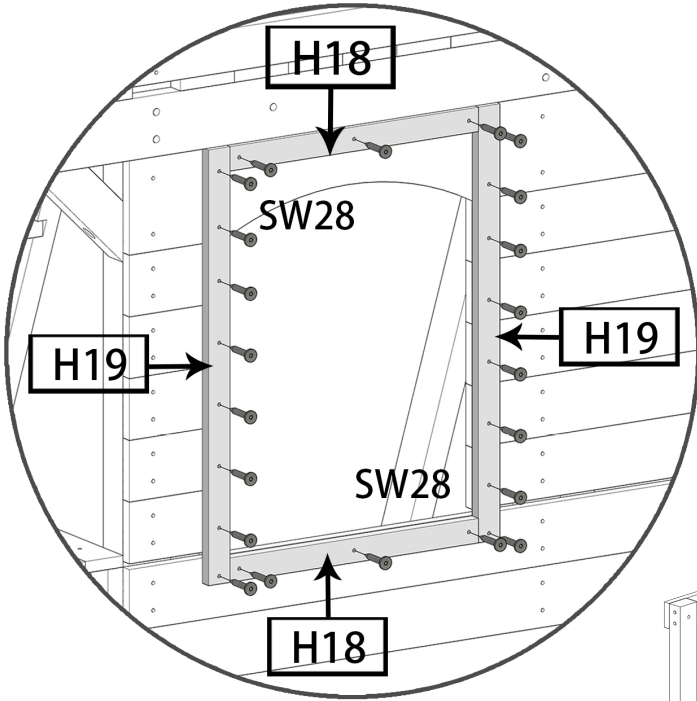

List	
Part NO.	Qty
H18	2
H19	2
SW28	22

**STEP 26**

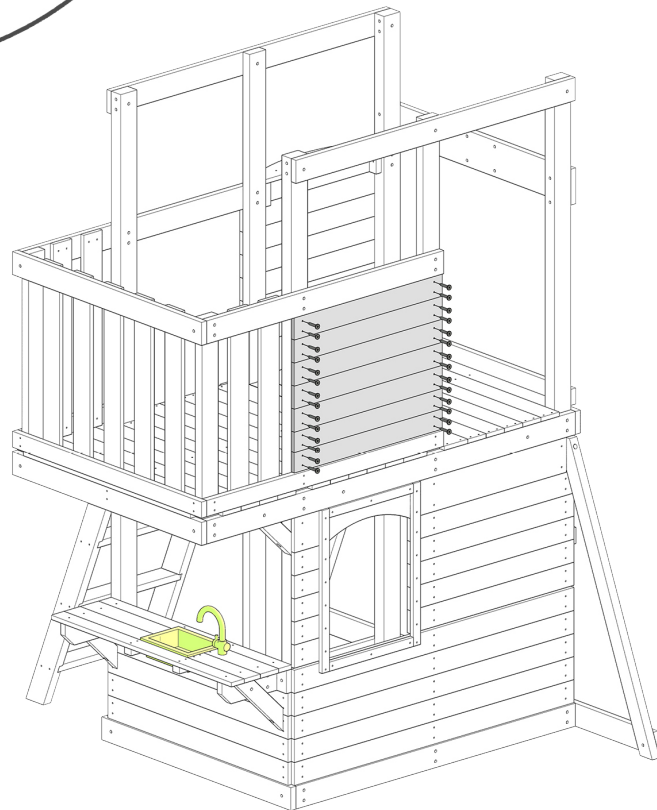
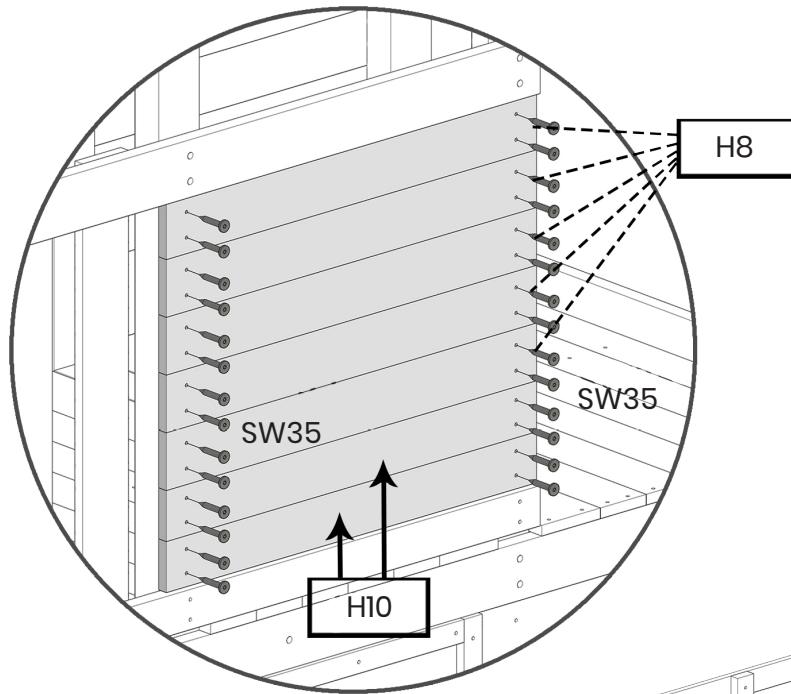

List	
Part NO.	Qty
H8	5
H10	2
SW35	28

**STEP 27**

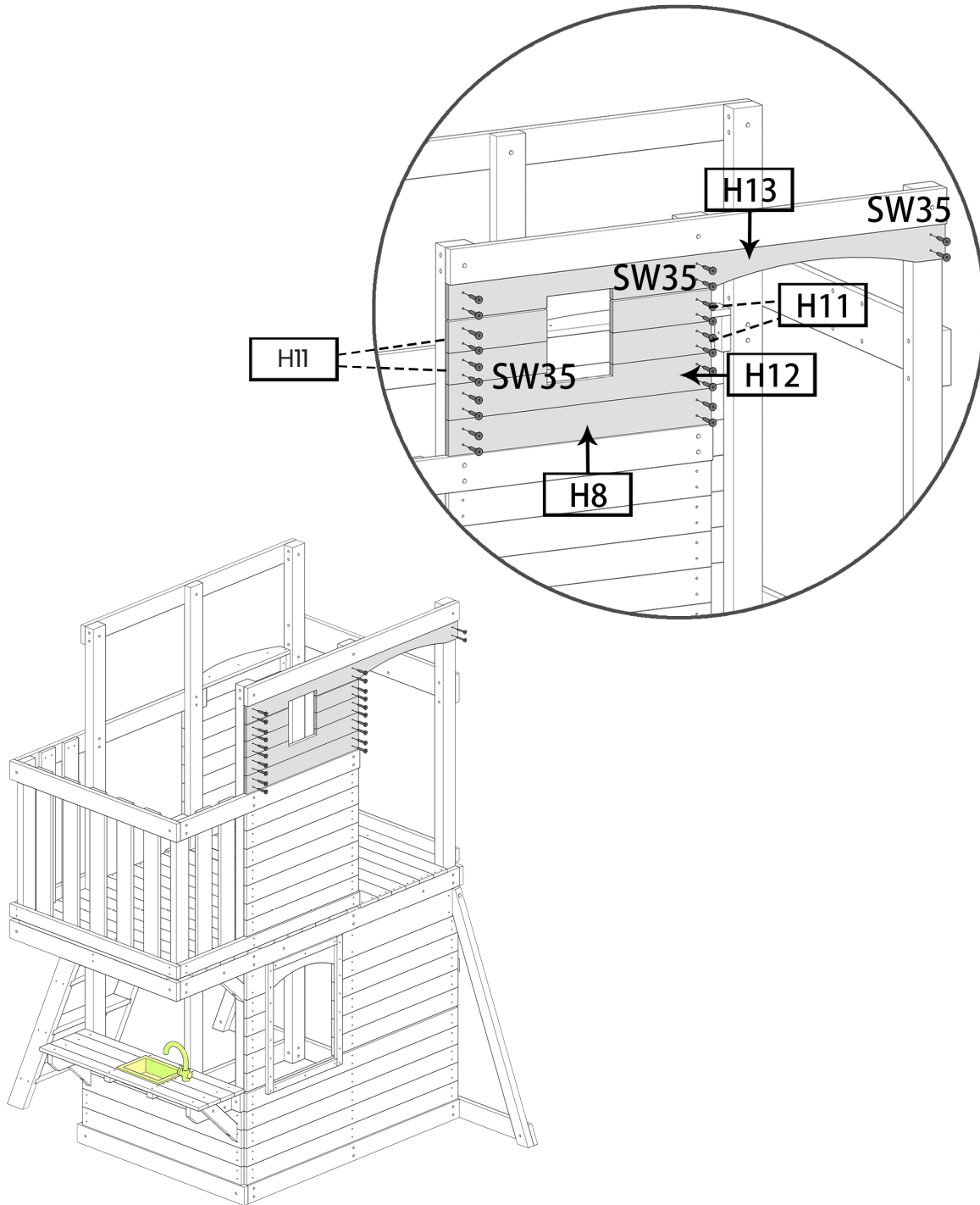

List	
Part NO.	Qty
H8	1
H11	4
H12	1
H13	1
SW35	22



**STEP 28**

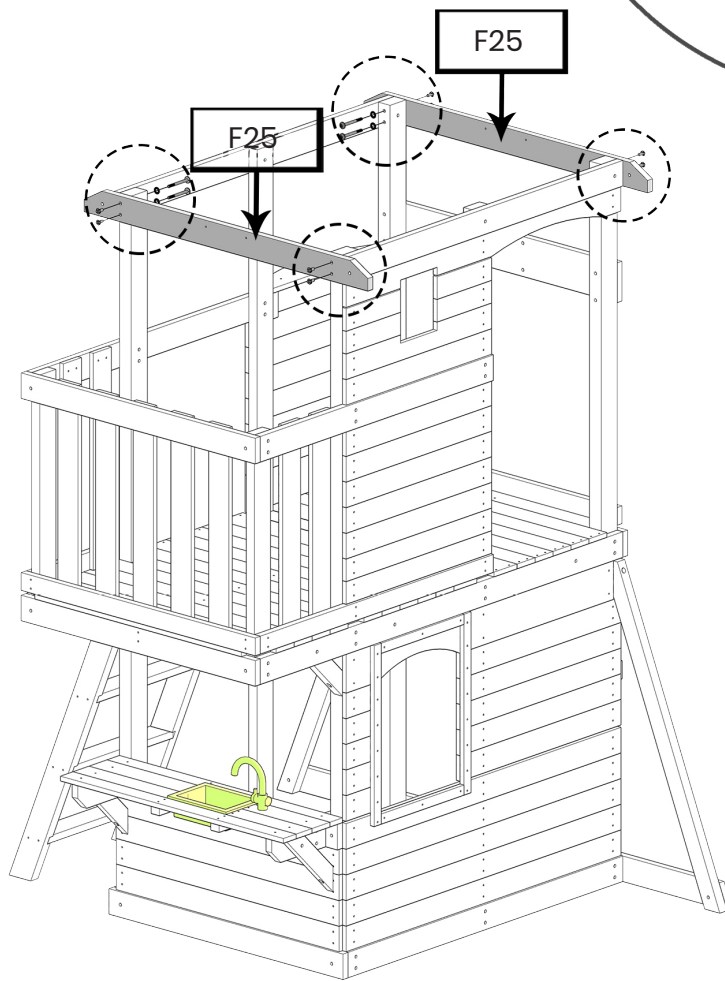
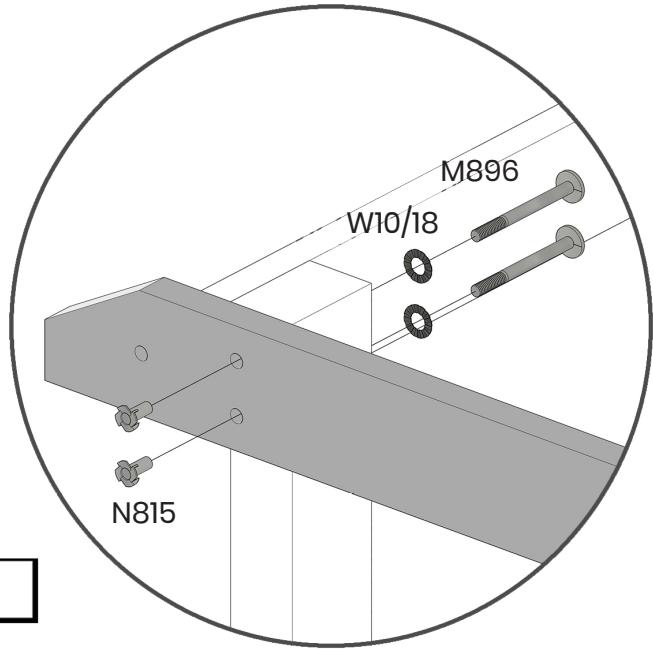

x4

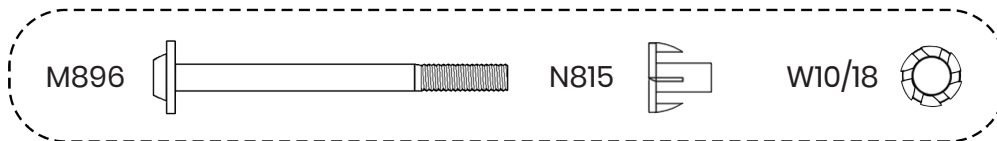

List	
Part NO.	Qty
F25	2
M896	8
N815	8
W10/18	8

**STEP 29**

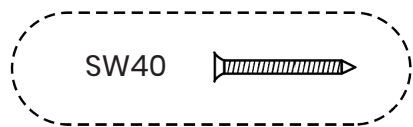
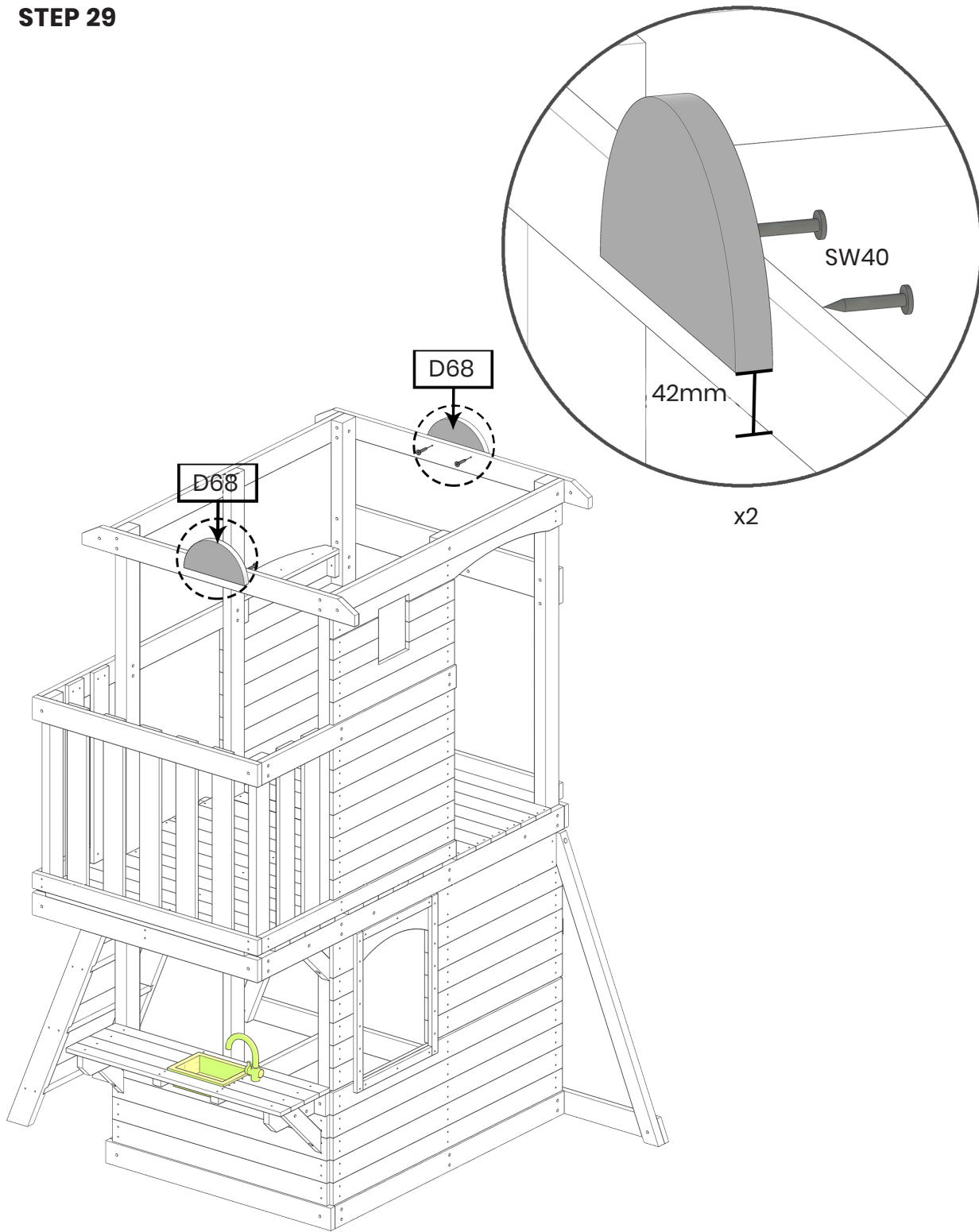

List	
Part NO.	Qty
D68	2
SW40	4

**STEP 30**

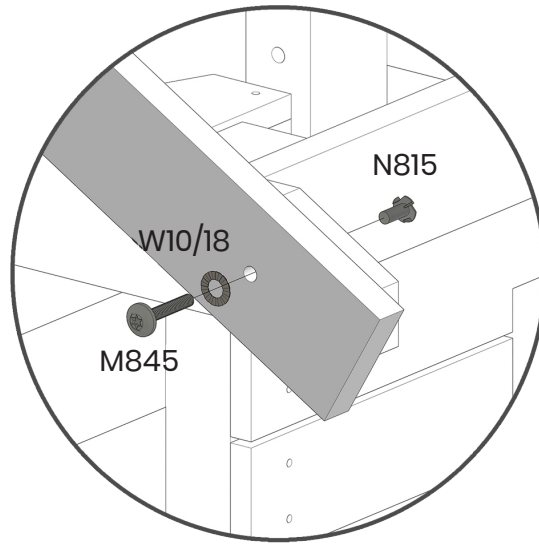
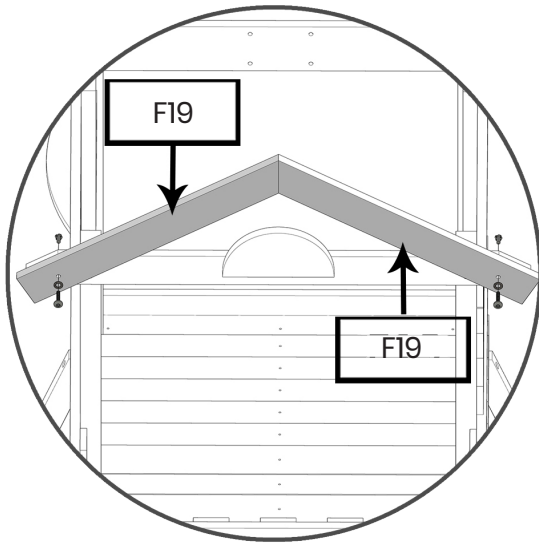

x2

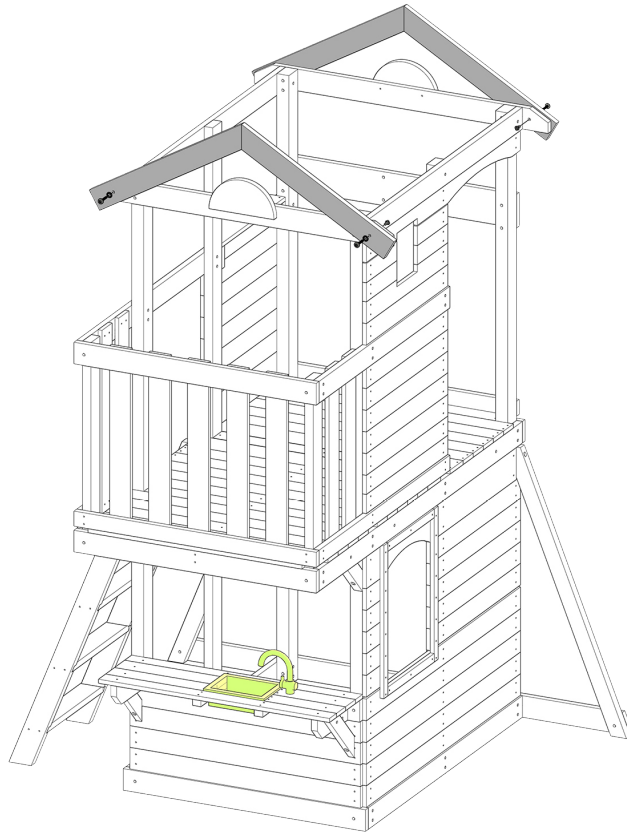

List	
Part NO.	Qty
F19	4
M845	4
W10/18	4
N815	4



**STEP 31**

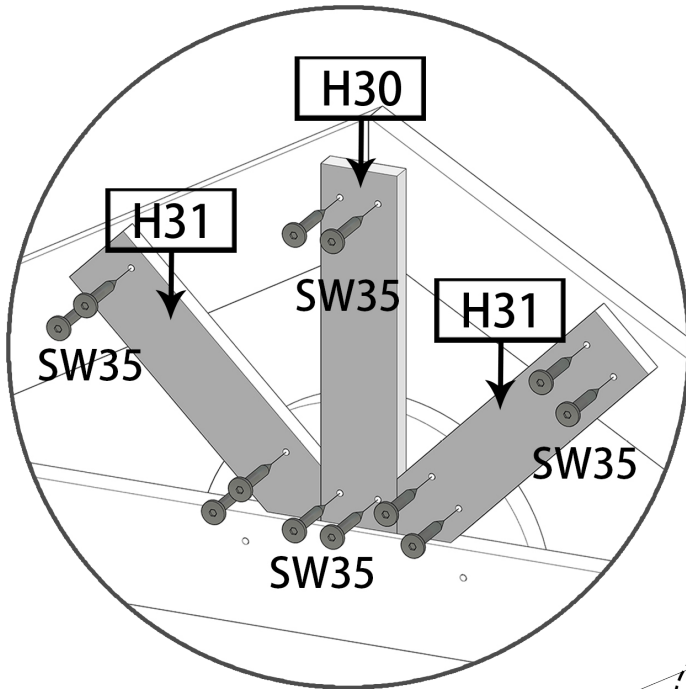

x2

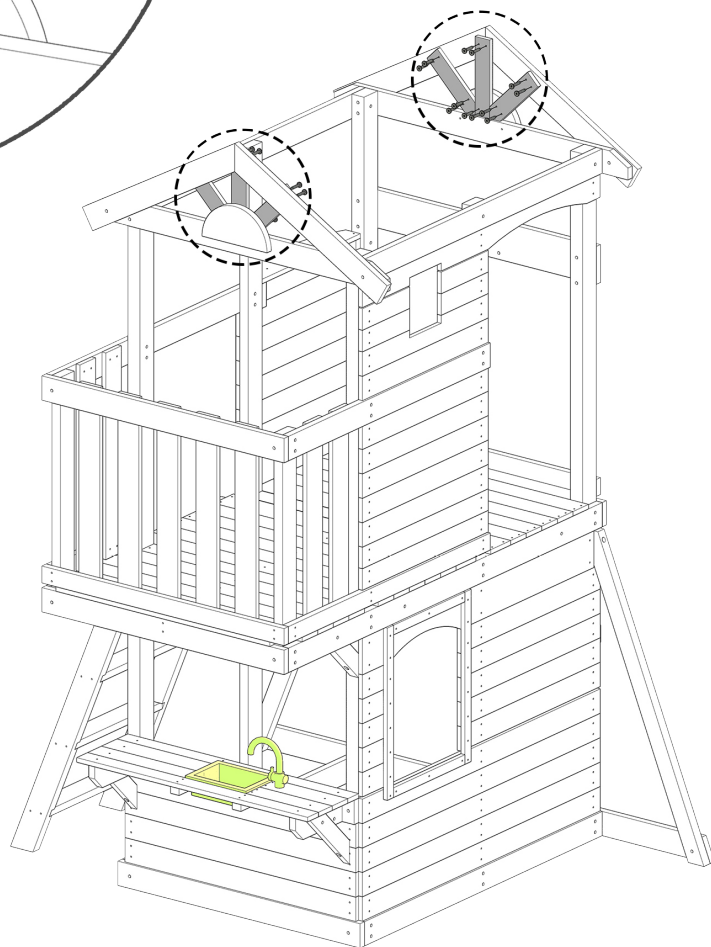

List	
Part NO.	Qty
H30	2
H31	4
SW35	24



**STEP 32**

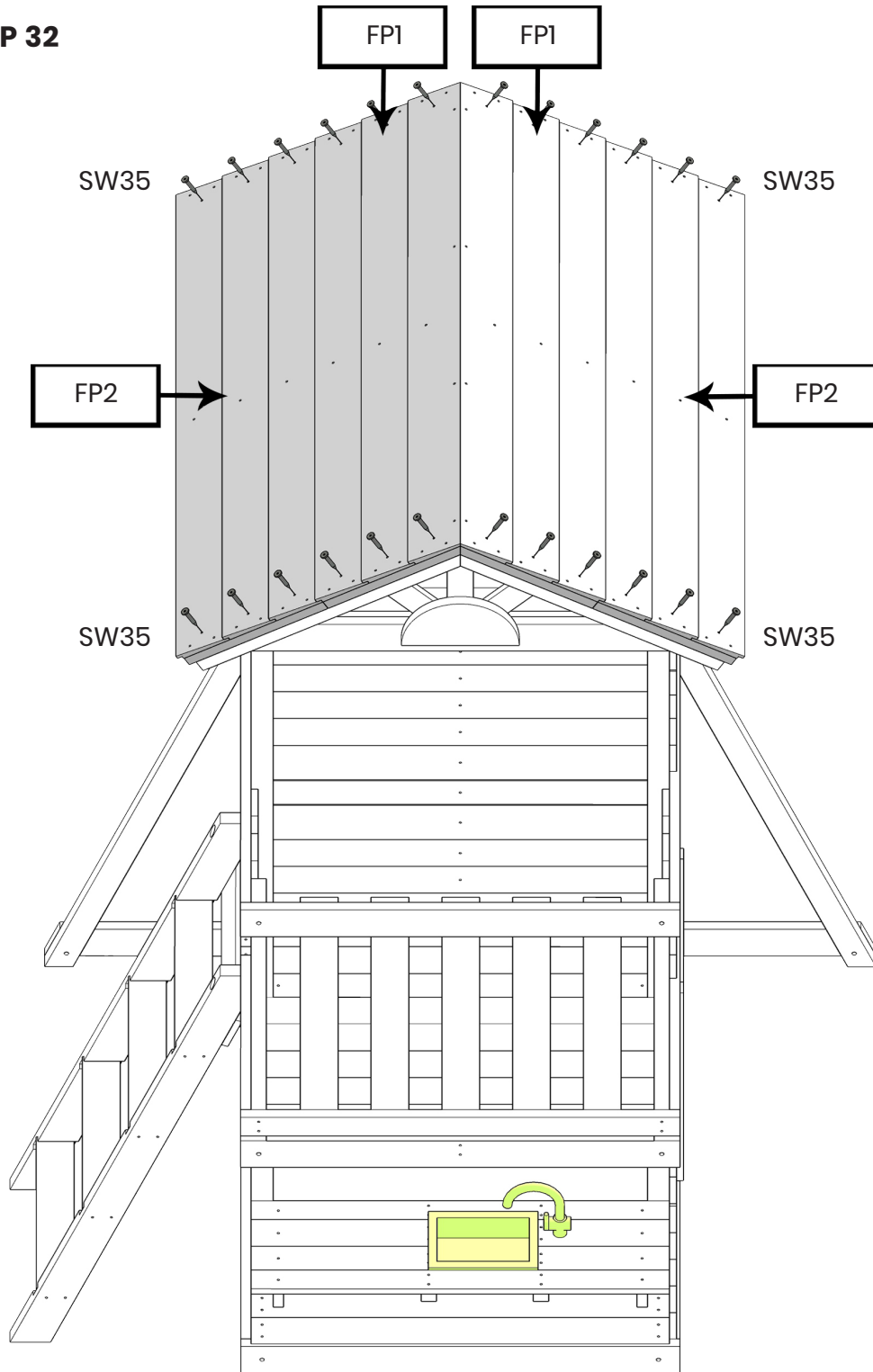

List	
Part NO.	Qty
FP1	2
FP2	2
SW35	24

**STEP 33**

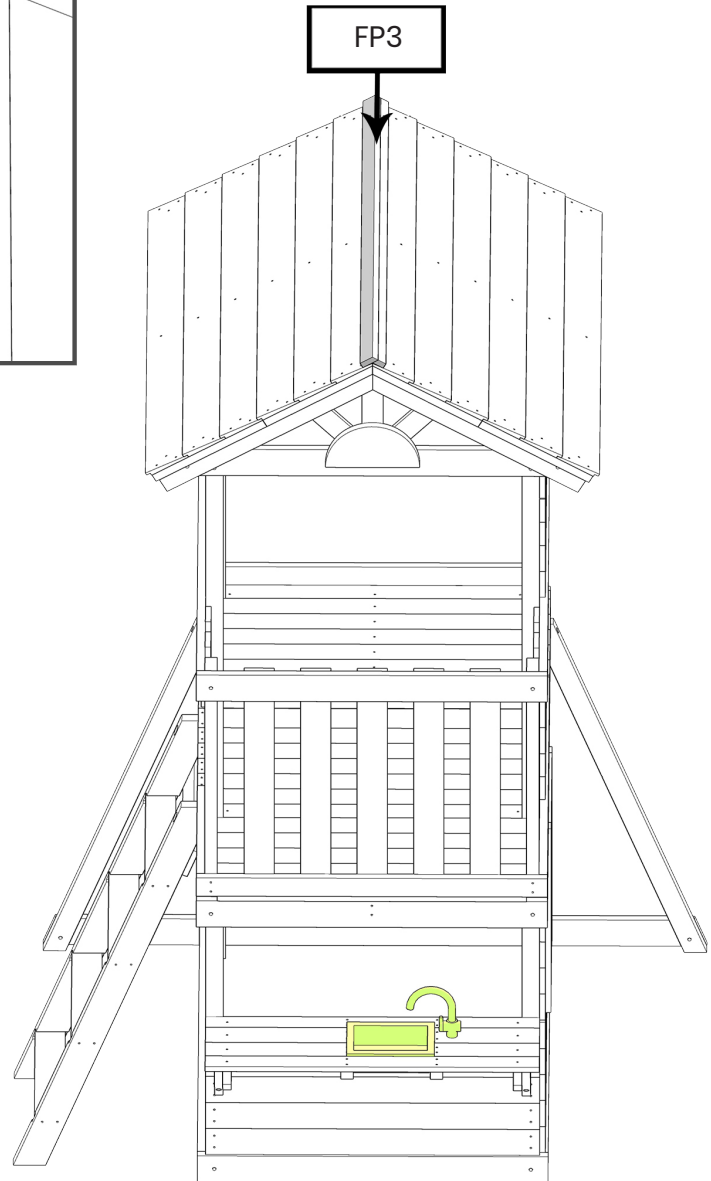
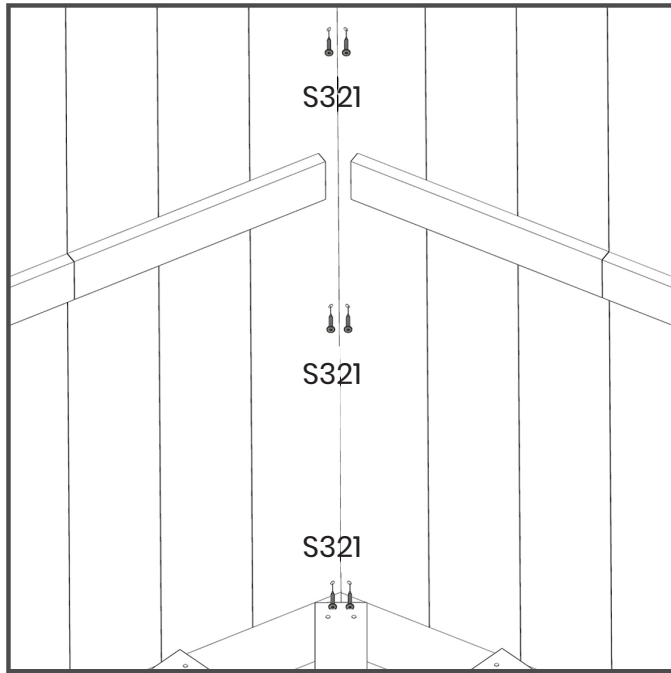

List	
Part NO.	Qty
FP3	1
S321	6

**STEP 34**

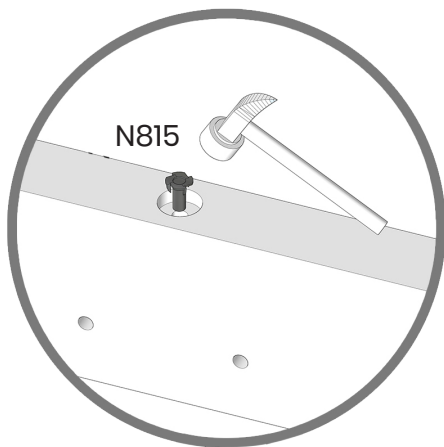
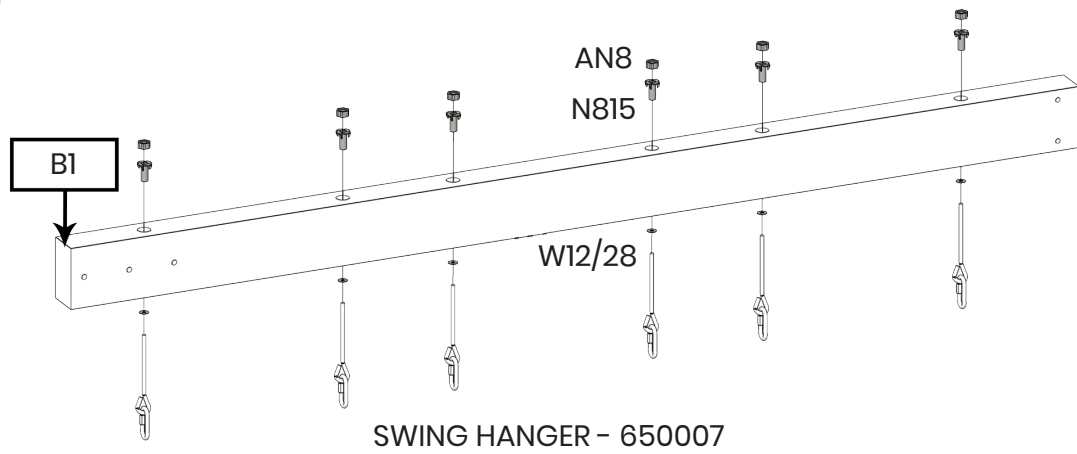

Insert the N815 into the beam by hammer

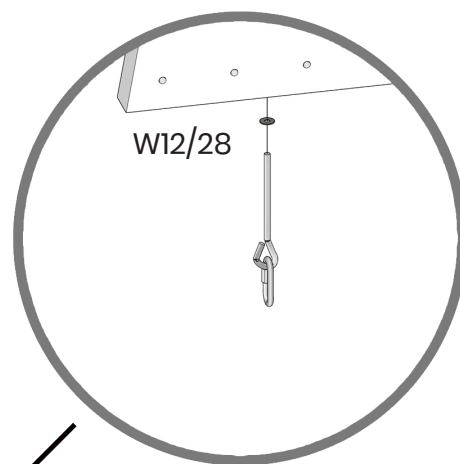

Insert the swing hanger into the beam and fix them with nuts N815 as tightly as possible

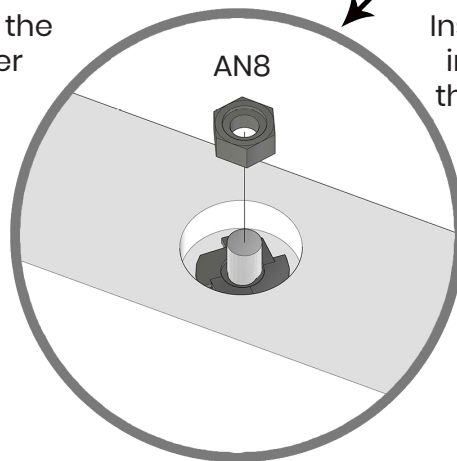

Fix the AN8 as tightly as possible



List	
Part NO.	Qty
B1	1
650007	6
AN8	6
W12/28	6
N815	6

**STEP 35**

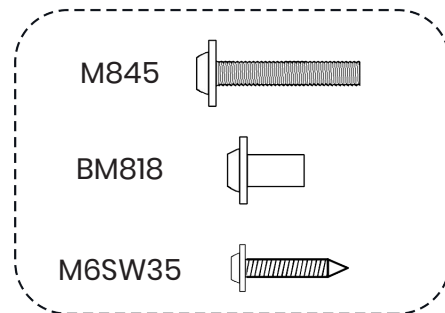
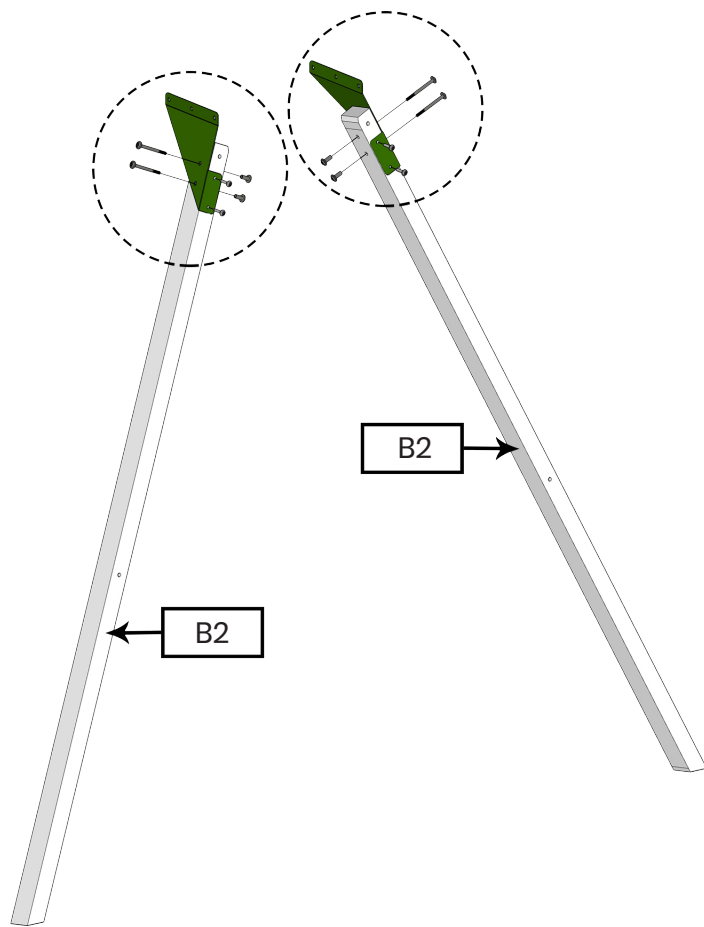
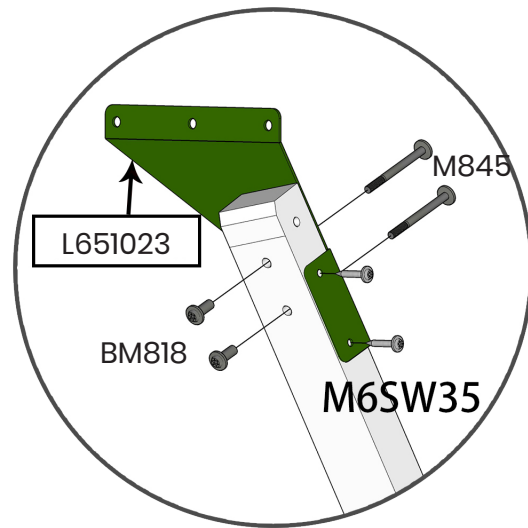
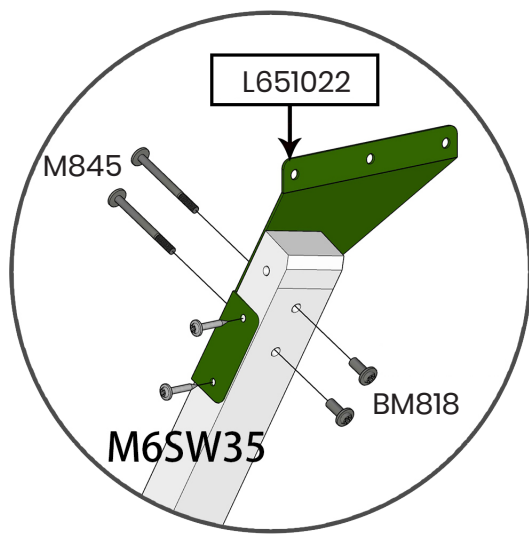

List	
Part NO.	Qty
B2	2
M845	4
BM818	4
M6SW35	4
L651022	1
L651023	1

**STEP 36**

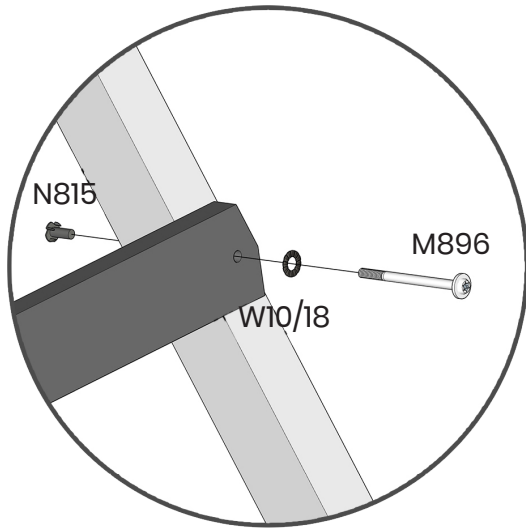

x2

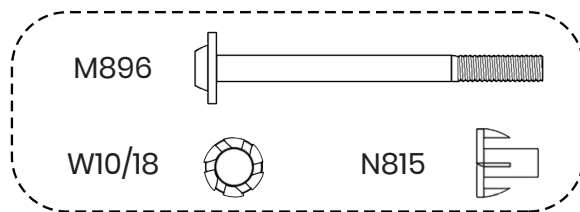
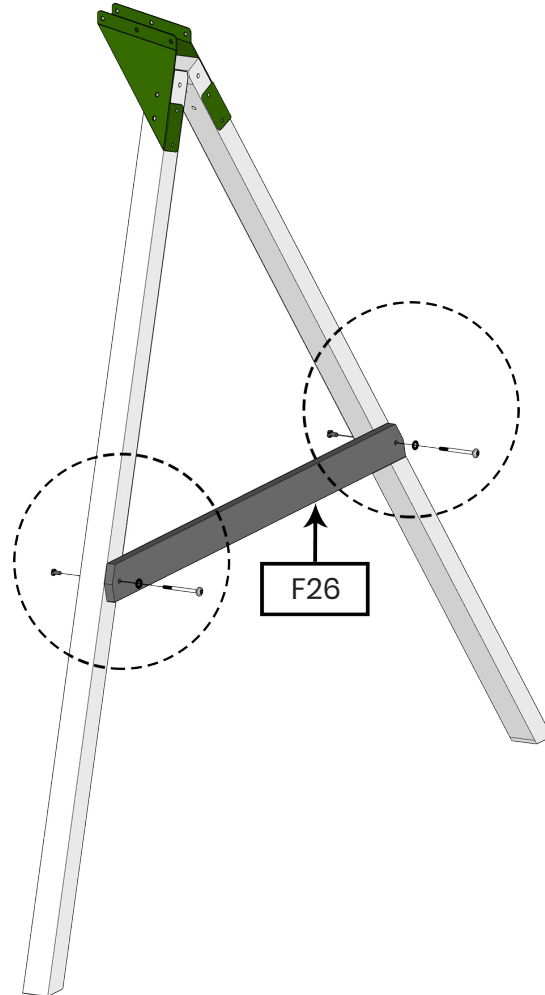

List	
Part NO.	Qty
F26	1
M896	2
N815	2
W10/18	2

**STEP 37**

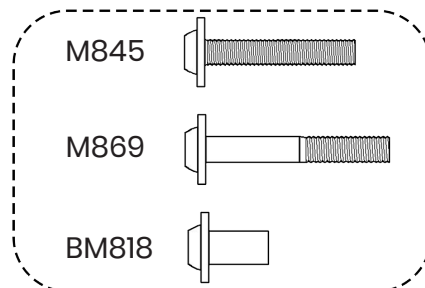
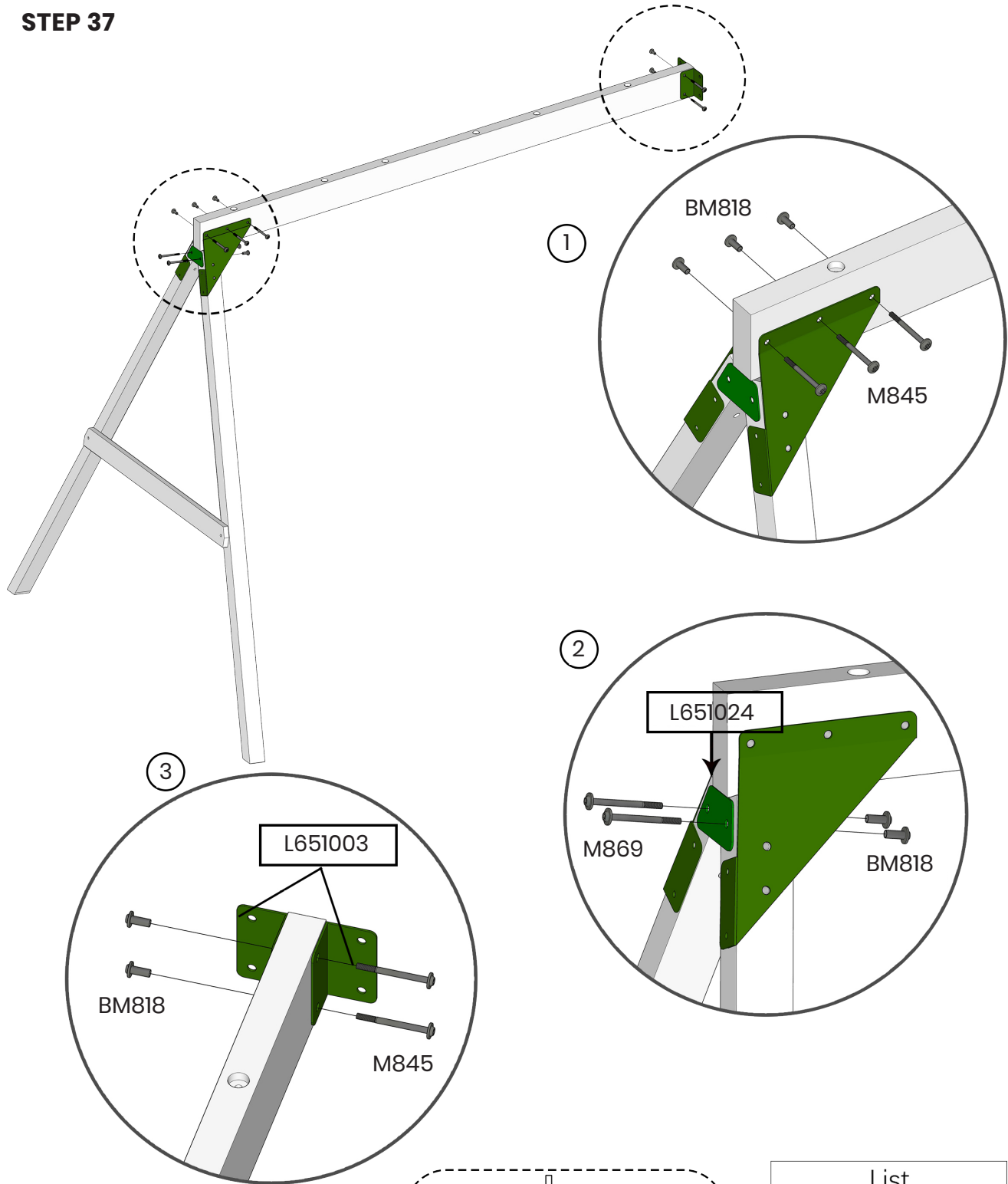

List	
Part NO.	Qty
M845	5
M869	2
BM818	7
L651024	1
L651003	2

**STEP 38**

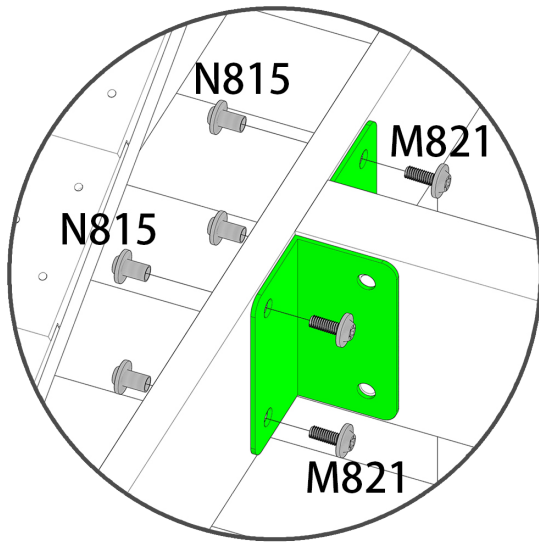

Hang the swing

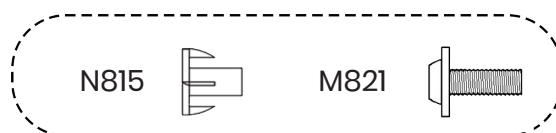
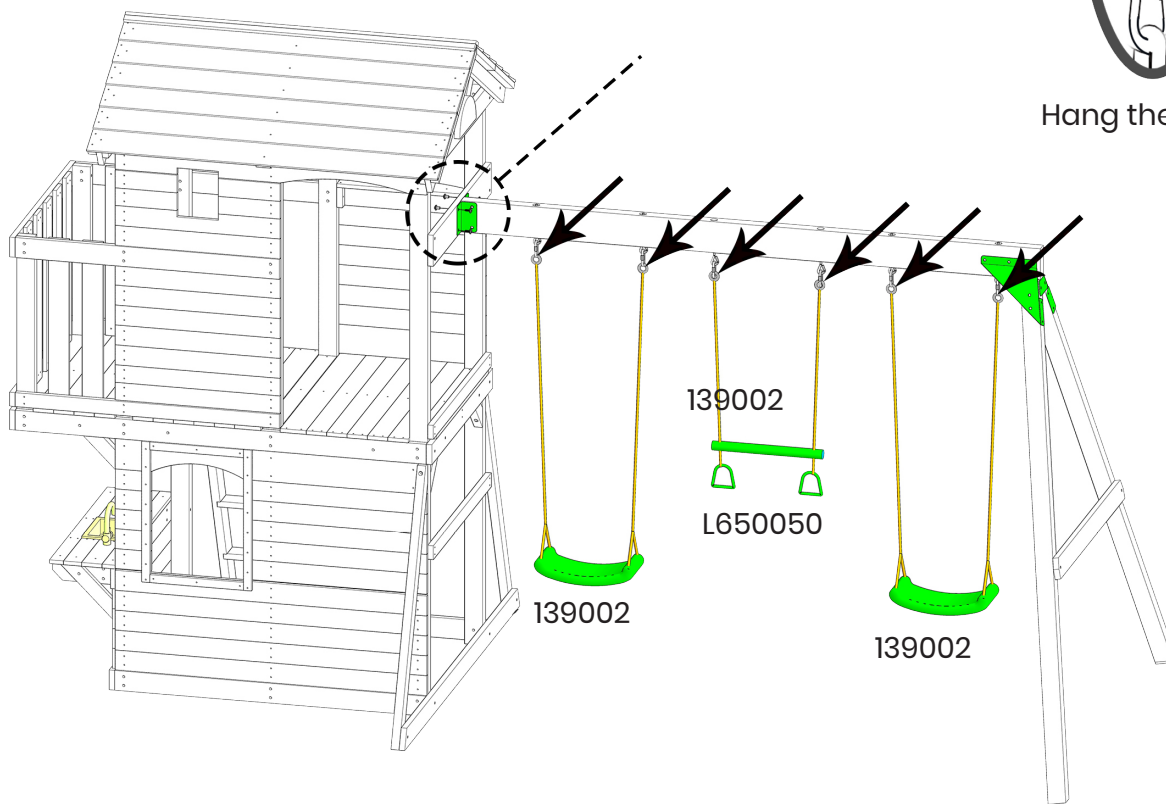

List	
Part NO.	Qty
M821	4
N815	4
139002	2
L650050	1

**STEP 39**

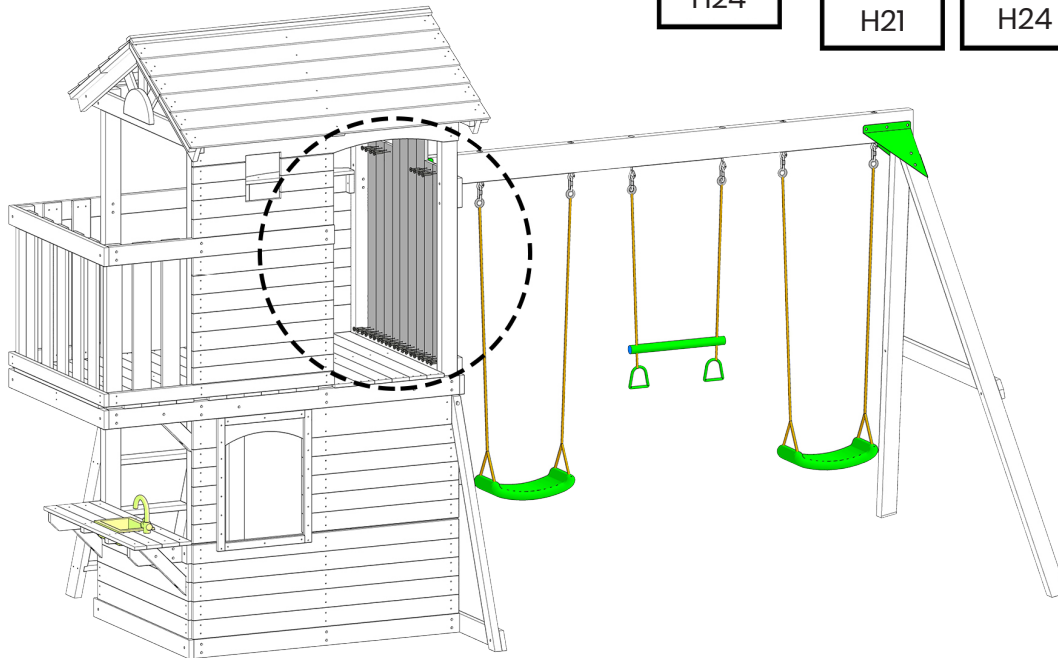
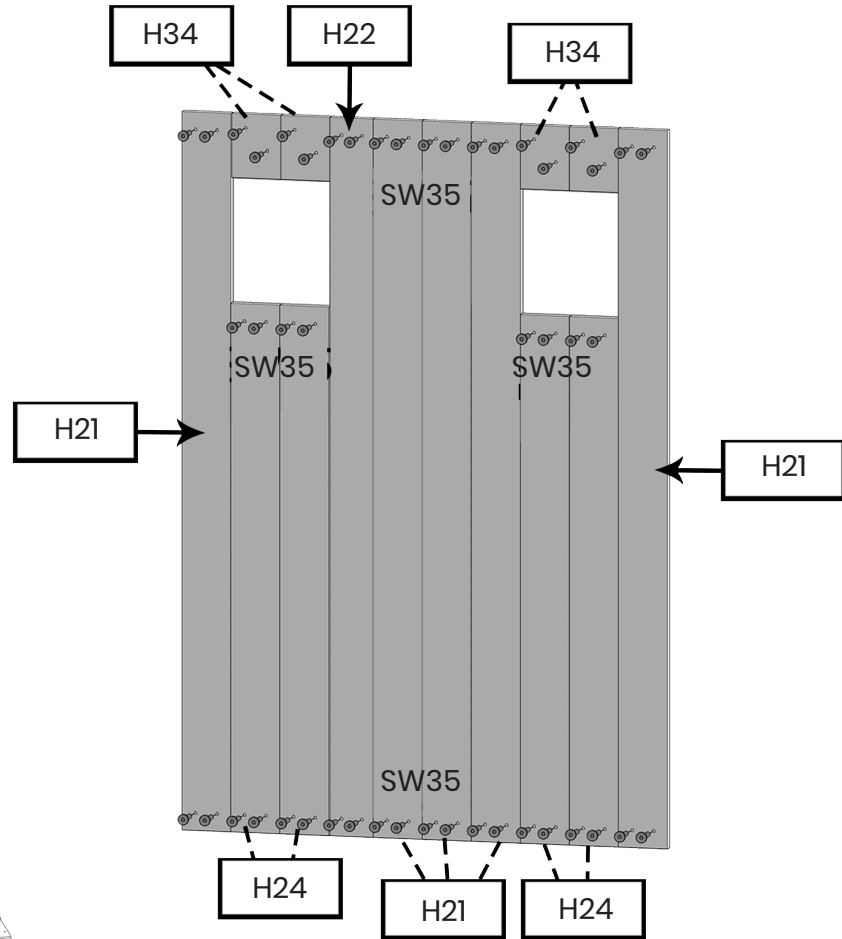

List	
Part NO.	Qty
H21	5
H22	1
H24	4
H34	4
SW35	48



**STEP 40**

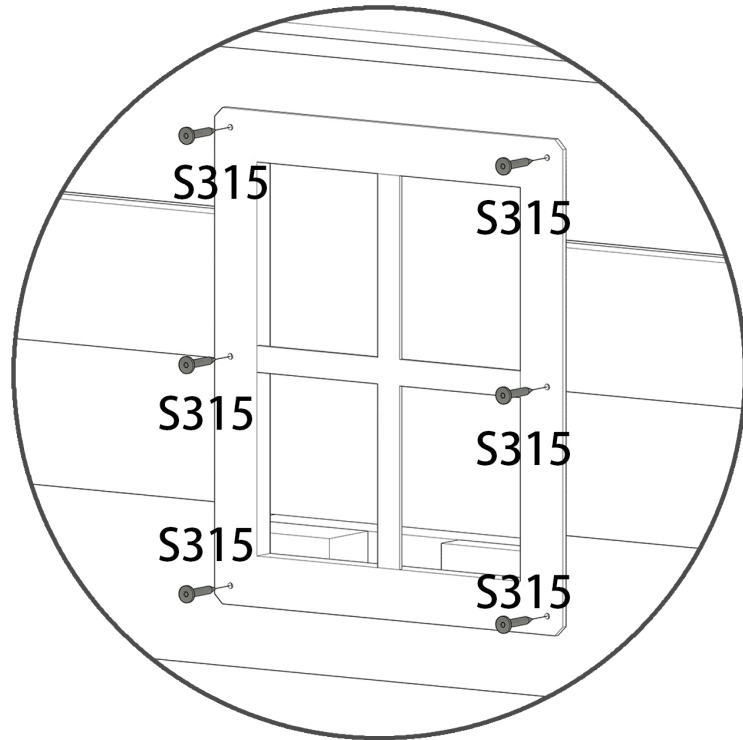

**650051** x3

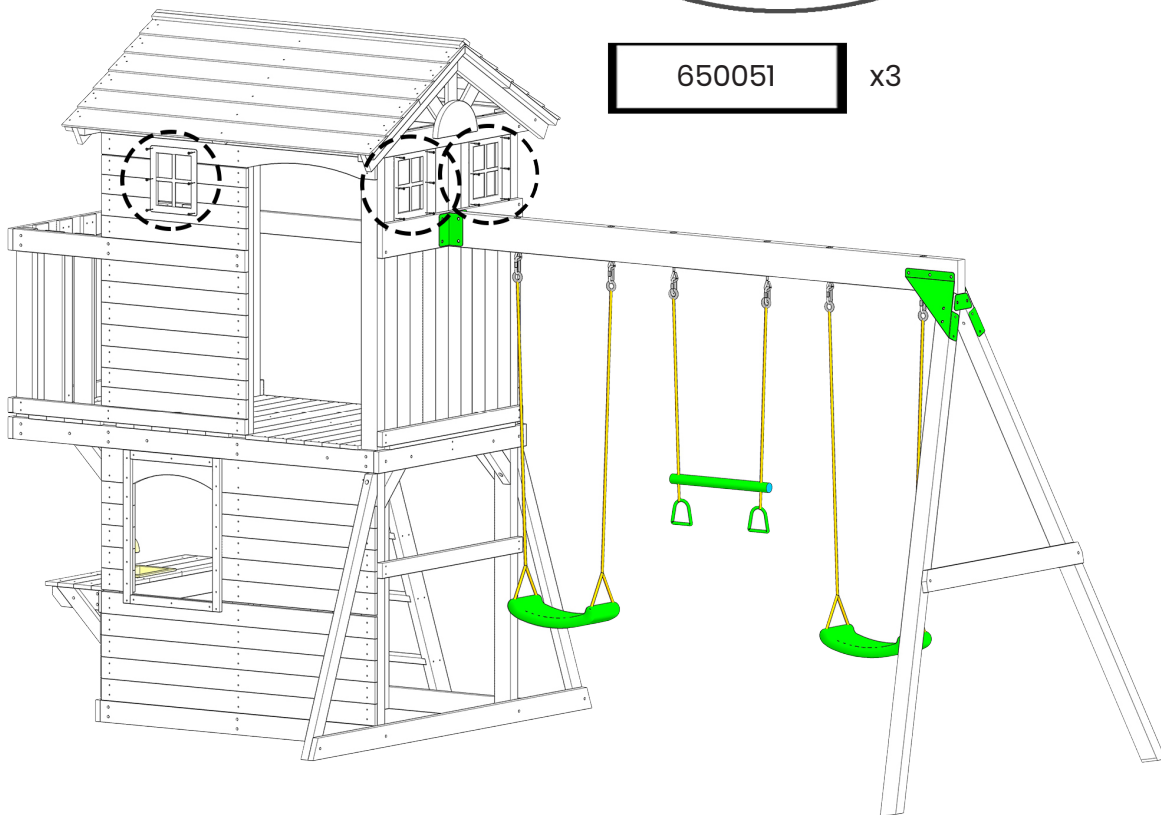

List	
Part NO.	Qty
S315	18
650051	3

**STEP 41**

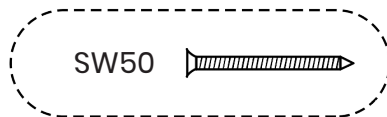
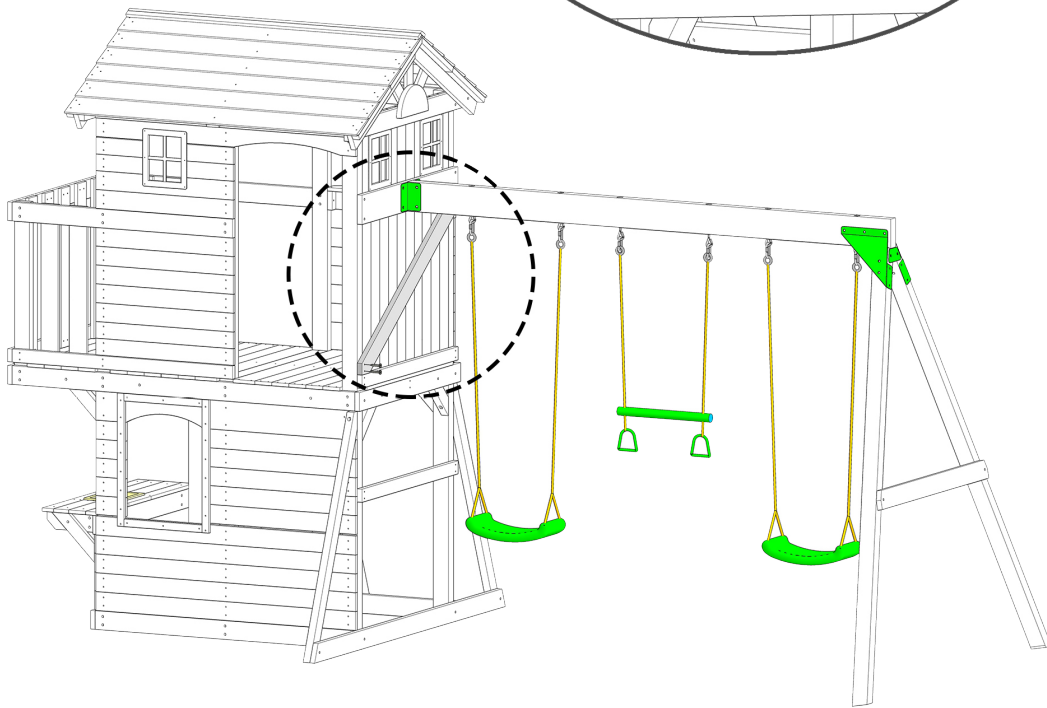
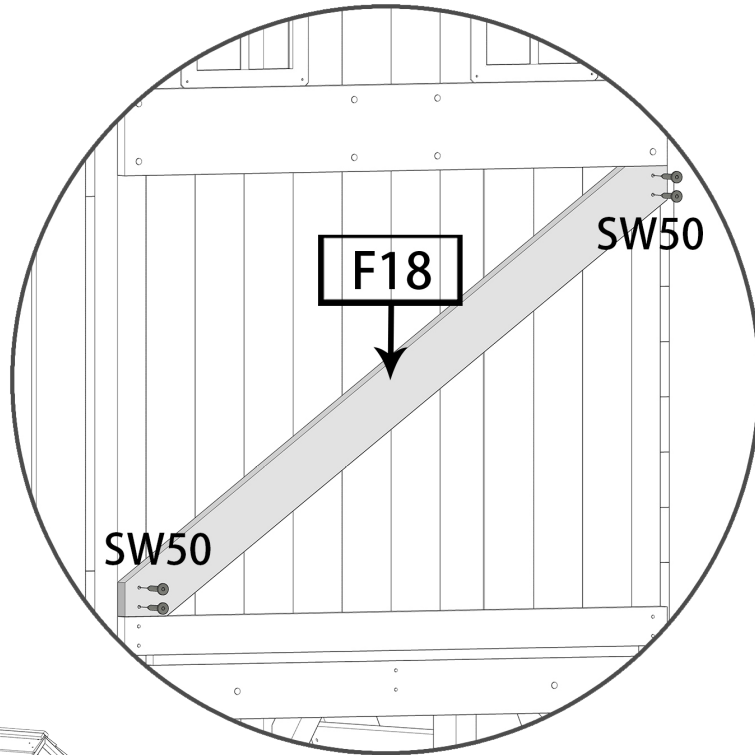

List	
Part NO.	Qty
F18	1
SW50	4

**STEP 42**

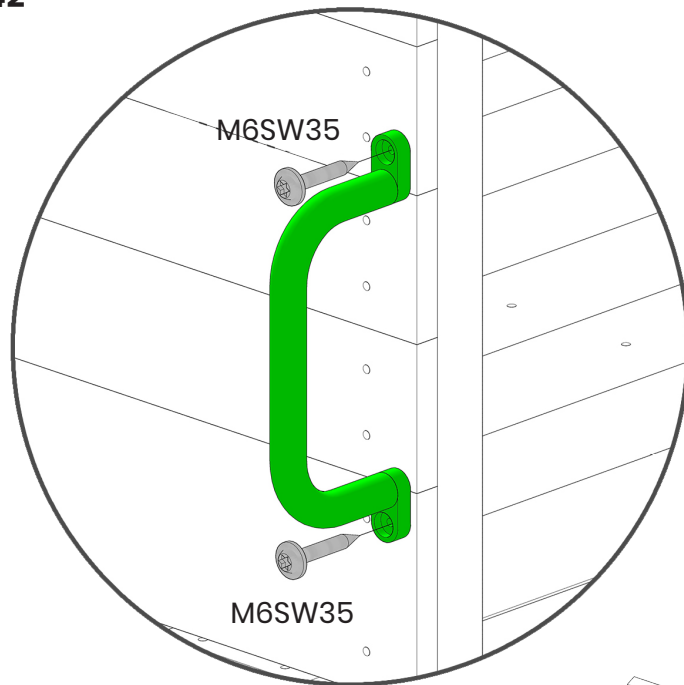

153003

x4

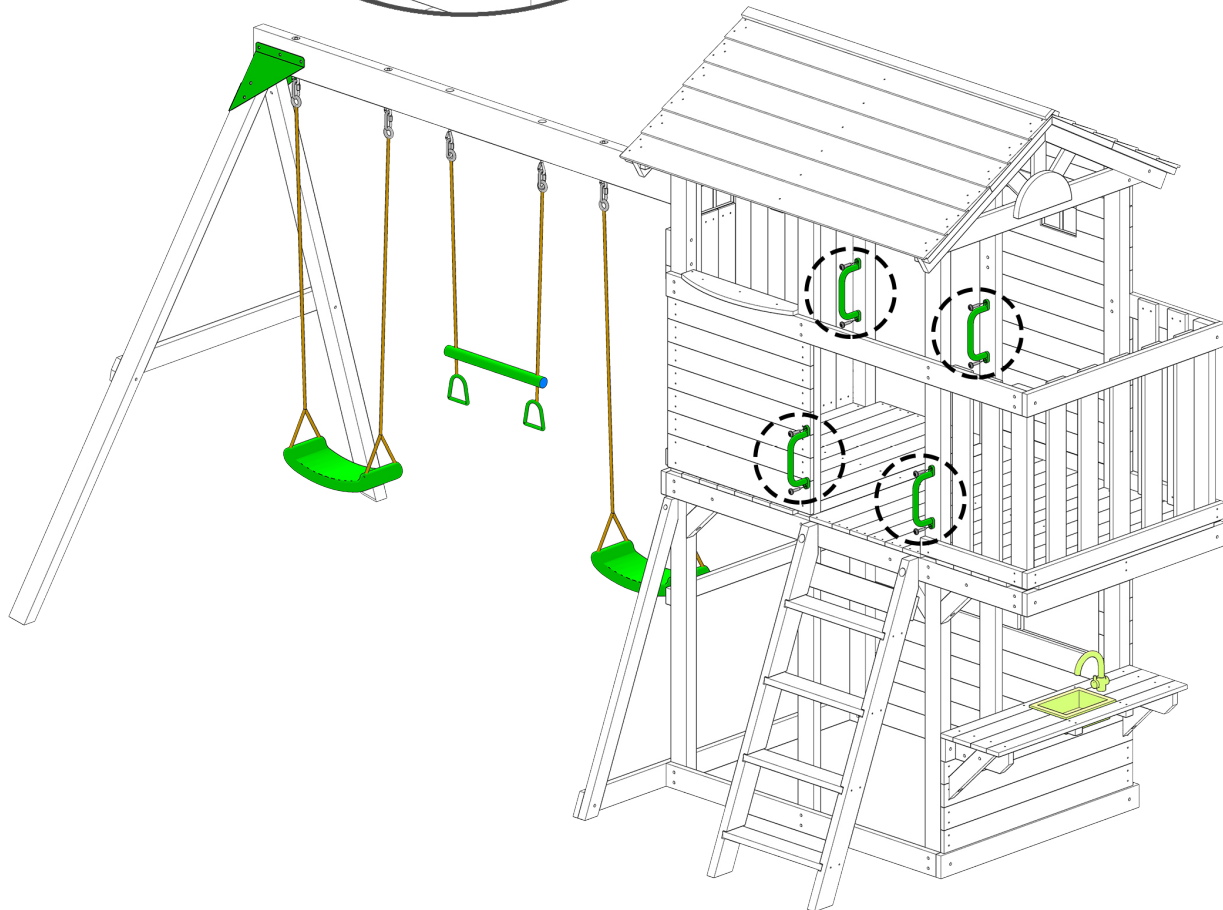

List	
Part NO.	Qty
M6SW35	8
153003	4

**STEP 43**

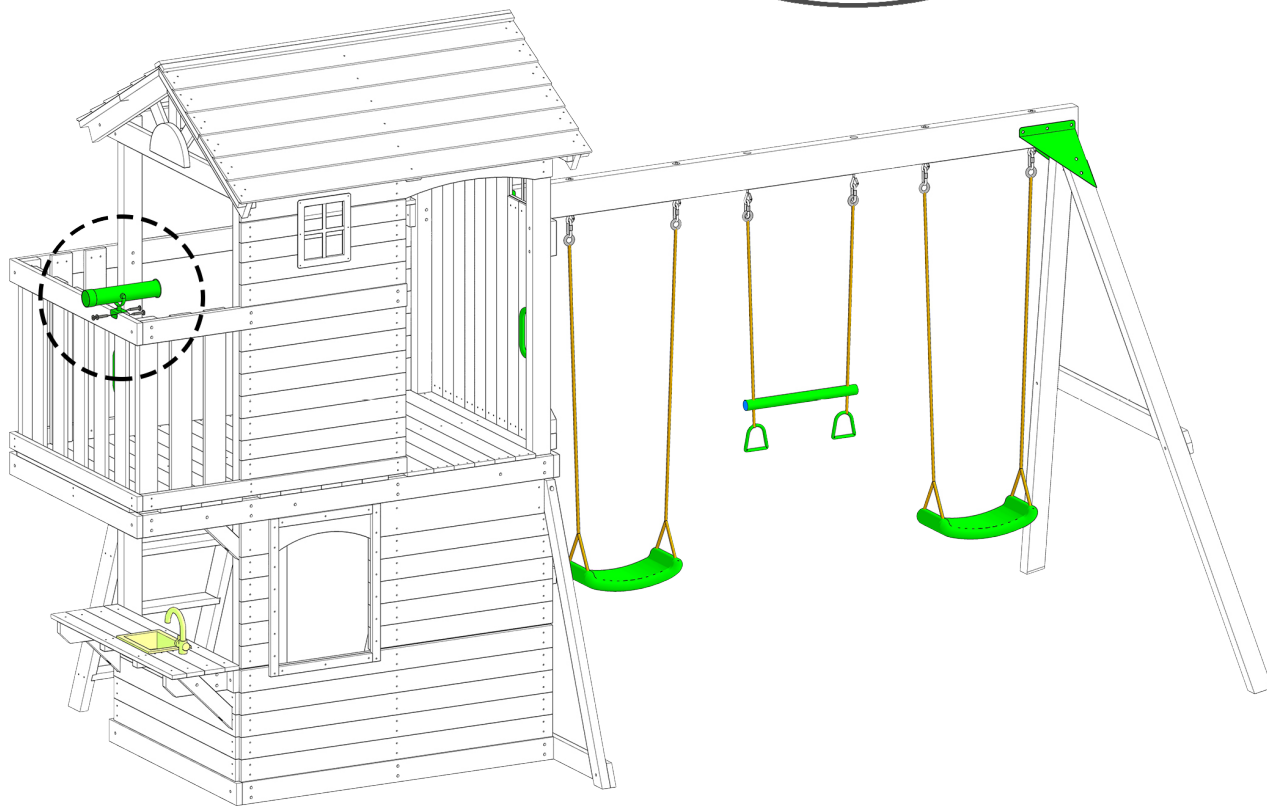
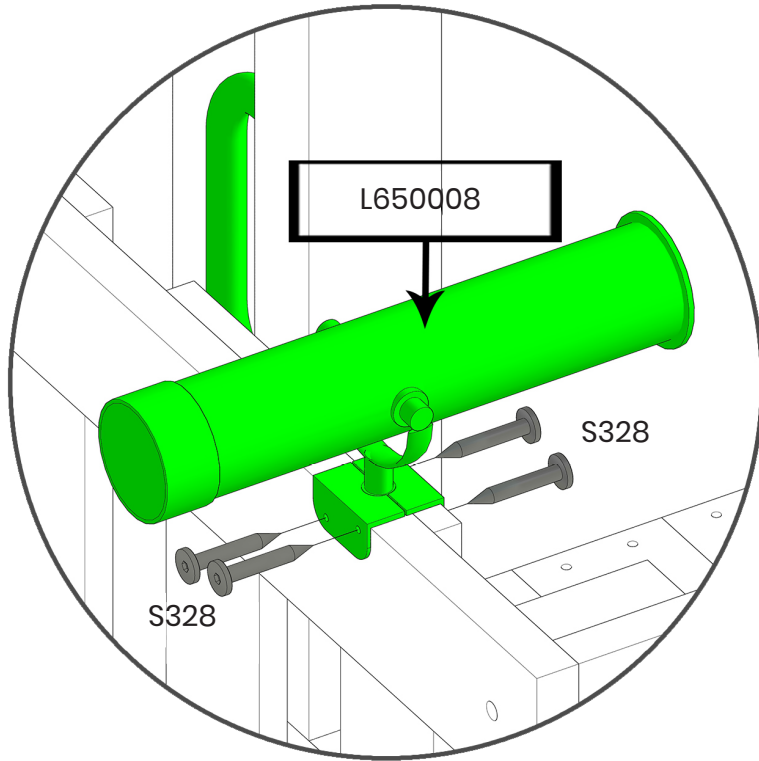

List	
Part NO.	Qty
S328	4
L650008	1

**STEP 44**

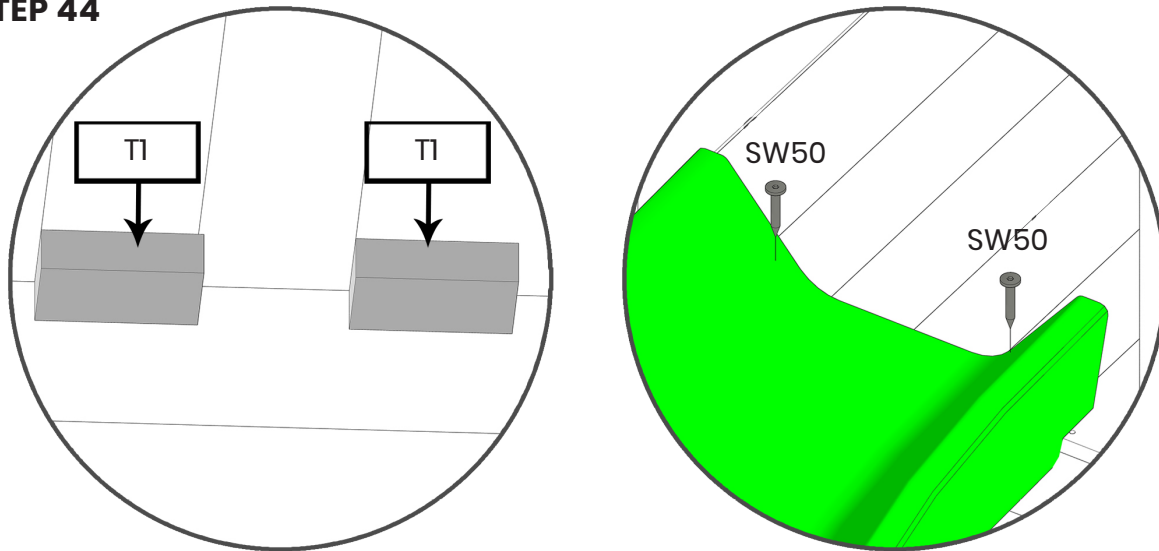

Put the slide braces T1 under the floor boards and fix the slide with floor and slide braces together

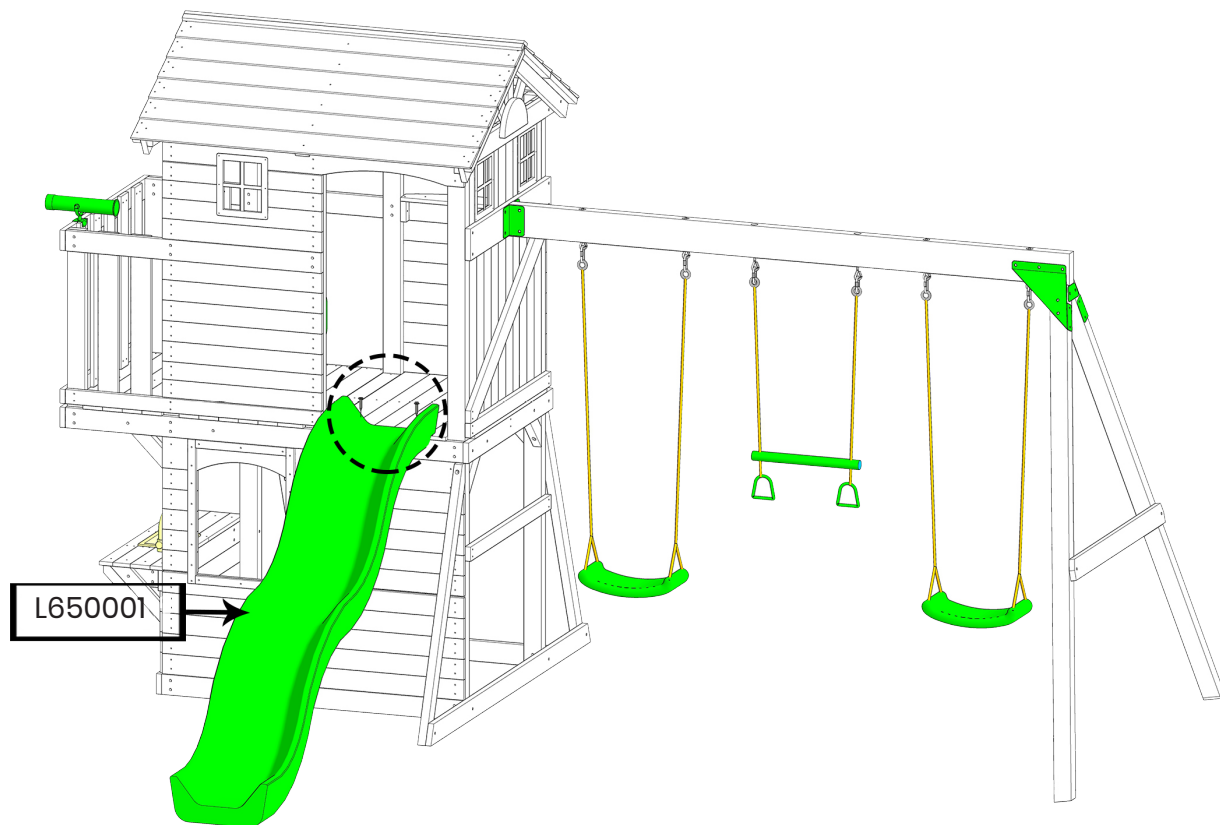

List	
Part NO.	Qty
T1	2
SW50	2
L650001	1

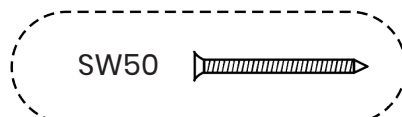

**STEP 45**

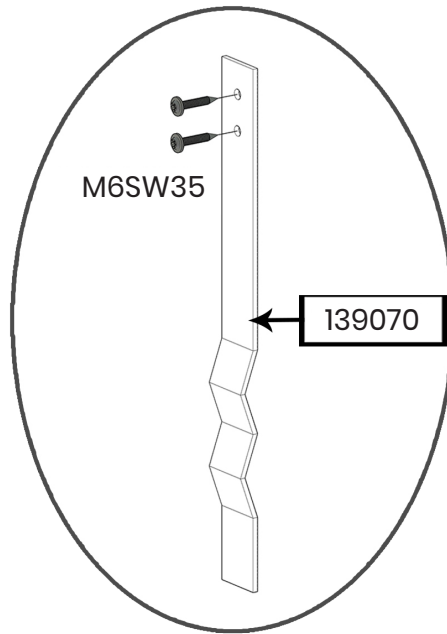
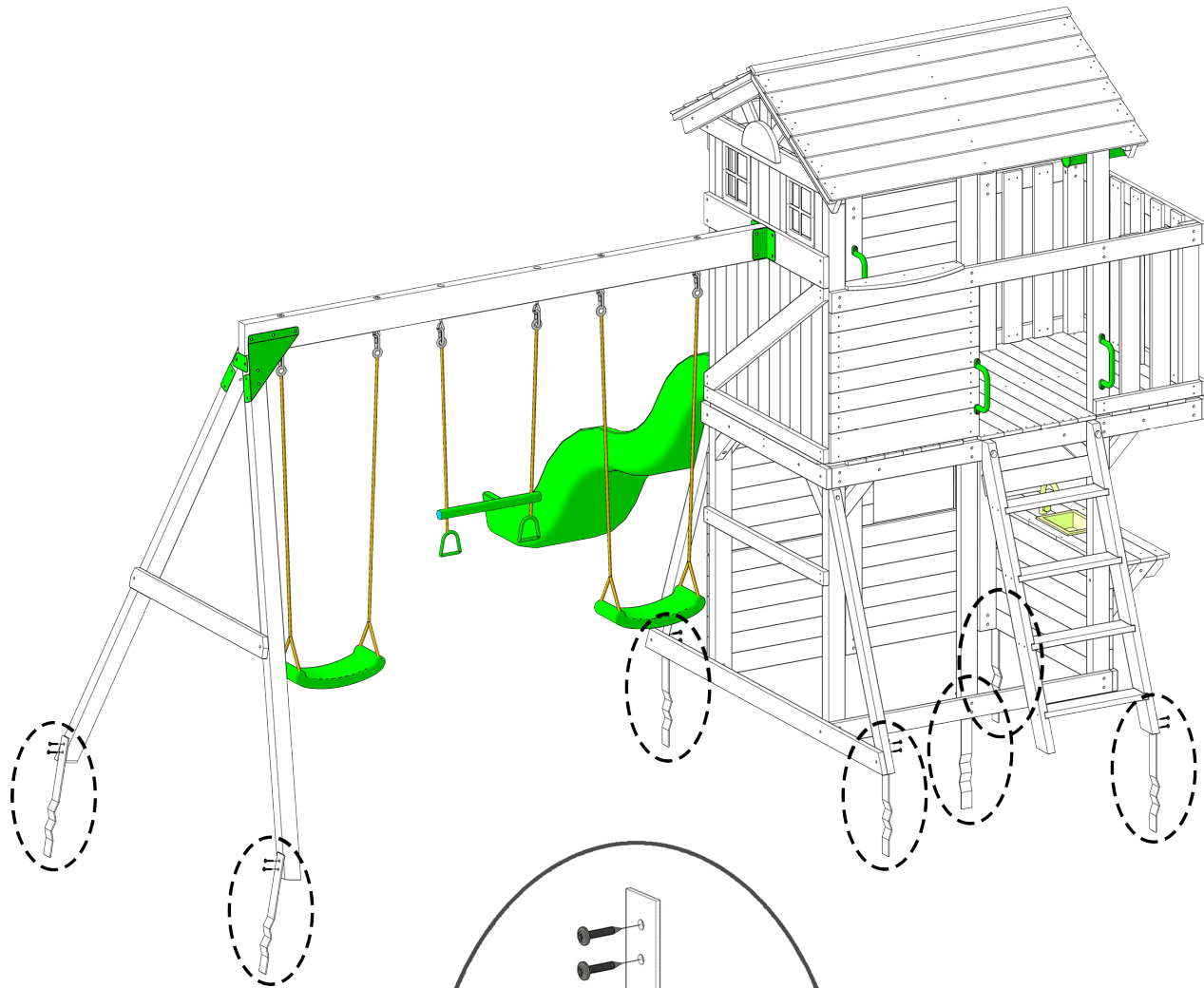

List	
Part NO.	Qty
M6SW35	14
139070	7

**STEP 46**

148001 x 1  
FBH-1 x 1

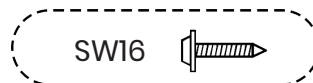
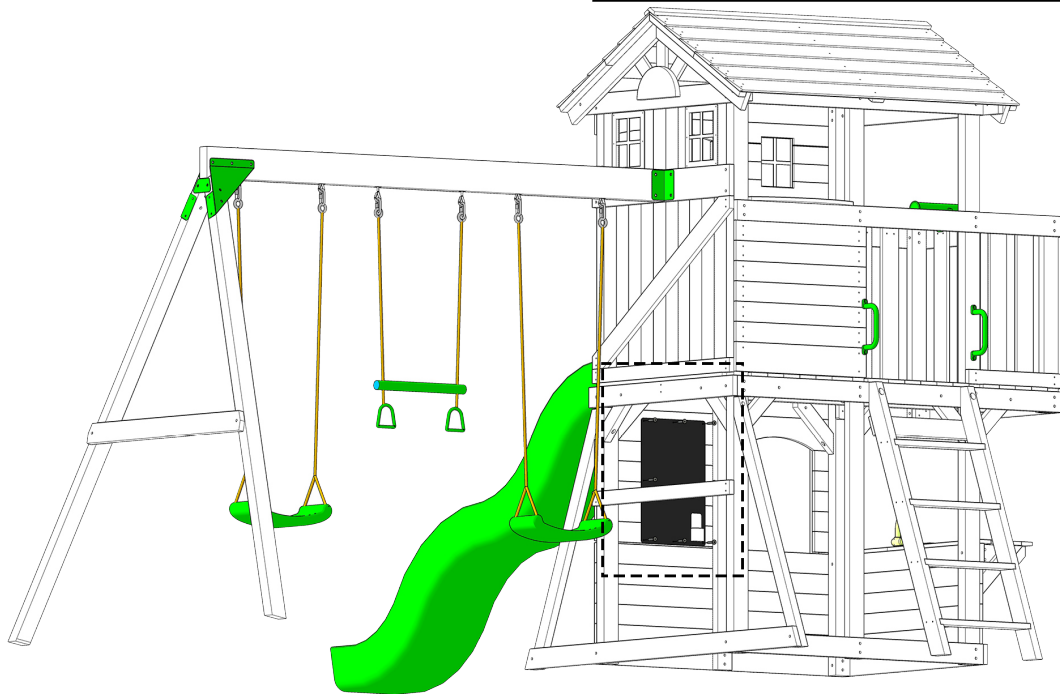
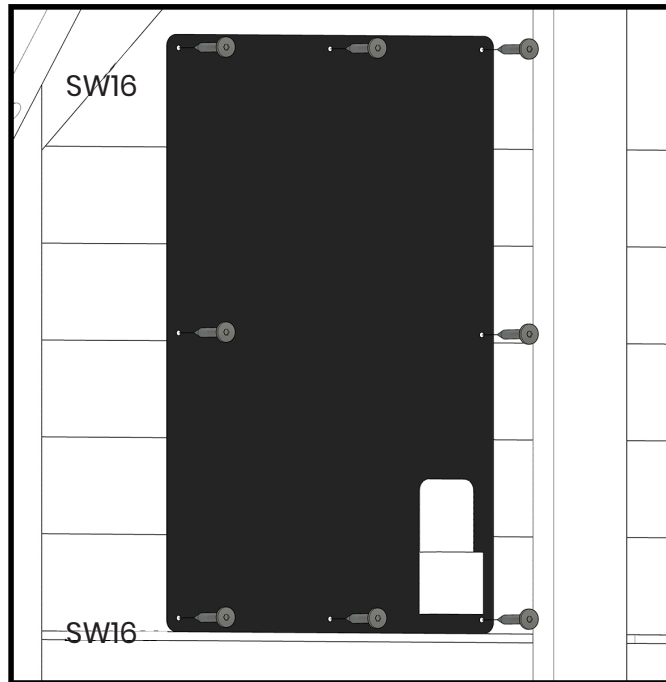

List	
Part NO.	Qty
148001	1
FBH-1	1
SW16	8

---

## IV. MAINTENANCE



**WARNING:** Please keep for future reference.

We recommend regular maintenance to be conducted at the beginning of each season as well as at regular intervals during the usage session for your play equipment to ensure all main parts/fixings are tightly secured, well-oiled and intact to avoid failure, injury or hazards.

### GENERAL ADVICE

It is of particular importance that this is followed at the beginning of each season as well as at regular intervals during the usage season.

- Check the accessories monthly as well as the play equipment's structure to prevent falling risks.
- Check and retighten screws, bolts, and all other hardware elements as necessary.
  - a. Do not over tighten to avoid damaging the thread or cracking the surrounding wood.
- Check all coverings and bolts for sharp edges and replace when required.
- Lubricate all moving metallic parts.
- Equipment situated in a high moisture or high salt content locations are more likely to oxidant and rust. Regular checks should be done more often. When signs of oxidation and / or rust appear on various metallic parts of your equipment, sand rusted areas and tubular members and repaint using a non-lead-based paint when required.
- Where applicable: check swing seats, chains, ropes, and other means of attachment for evidence of deterioration.
- Replace when required in accordance with the owner's manual.

If your play structure is disassembled, be sure to clearly mark any attached metal plates to prevent accidents. Check all bolt covers and sharp edges and replace them if necessary.

For longer accessory life, we suggest storing them during the winter.



---

## V. PLAY SET ASSEMBLY MANUAL FAQs:

### 1. Does the area for the playset need to be level?

Yes. We recommend the playset be positioned on a flat level area for maximum safety and durability. The stakes provided should be used to secure it firmly to the ground.

### 2. What age range is appropriate for the playsets?

The playsets are recommended for children ages 3 – 10 years.

### 3. Is the wood treated with chemicals?

We use 100% Chinese Cedar wood which is naturally bug resistant, decay and rot resistant. To help ensure your child's safety, our wood is completely chemical free and we do not use pressure-treated wood. The stain we use is a top coat using a waterbased product that is for appearance only.

### 4. How often should the playset be stained?

We recommend the playset be stained once each year. A water or oil based stain can be used at the customer's discretion.

### 5. Why does it seem that my swing set is developing cracks?

Wood is a natural material; no two pieces are exactly alike. Each piece has its own characteristics and personality and reacts differently to climate changes. When any wood product is exposed to the elements, it develops "wood checks". A check is the radial separation of the wood fibers running with the grain of the wood. These are caused by the varying temperature and moisture conditions. A check is not a crack – it does not affect the strength or durability of the wood or structural integrity of the play set.

### 6. Do the playsets come with a warranty?

Yes. All Lifespan Kids products carry replacement warranty on all parts for manufacturer's defect. Please see warranty details for more information.

### 7. What is the best way to get started assembling the playset?

We recommend taking all the parts out of the boxes and arranging them by part number before you begin any assembly. This will not only allow faster assembly, but will also identify any parts that may be missing or damaged so they can be replaced before assembly.

### 8. The playset seems to rock or sway too much. What's wrong?

Rocking is caused by uneven ground or obstructions such as rocks, roots, etc. under the ground rails. These should be removed and the ground underneath re-leveled to prevent rocking. Also ensure the playset is securely staked to the ground using the anchors provided.

### 9. The end beam is not straight up and down. Why not?

This is normal. Lifespan Kids designs playsets this way to ensure the strongest structure possible. The slight angle adds strength and reduces rocking and twisting.

---

## VI. WOOD ADVICE

Our products are manufactured from premium timber. Great care is taken in selecting, machining, and treating the timber before it is sold to you.

1. Inspect wood parts monthly. The grain of the wood sometimes will lift in dry periods causing splinters to appear. Light sanding may be necessary to maintain a safe environment. Treating your Product with protection (sealant) after sanding will help prevent severe checking/splitting and other weather damage.

2. The wood is treated via high temperature drying, degreasing and is stained against wood rot and insect damage (Termites not included). This is not a permanent treatment as weather conditions can wear it down. We recommend once or twice a year, depending on your climate conditions, you must apply some type of protection (sealant) to the wood of your unit. Prior to the application of sealant, lightly sand any "rough" spots on your set. **Please note this is a requirement of your warranty.**

Bear in mind that timber is a natural product and may experience changes throughout the course of its life. It may:

- Develop openings/checks (gaps, slits, apertures, cracks) along the line of the grain.
- Fade as the timber reacts with sunlight.

All woods are hygroscopic, that is, it will absorb or discharge moisture to attain equilibrium with the surrounding atmosphere. Timber openings/checks occur due to the moisture content between internal and outer surfaces of the timber. No two pieces of wood are exactly alike. Each piece has its own characteristics and personality and reacts differently to climate changes. When any wood products are exposed to the elements, it develops 'wood checks'. A check is the radial separation of the wood fibres running with the grain of the wood. These are caused by the varying temperature and moisture conditions. A check does not affect the strength or durability of the wood or structural integrity of the play set.

## WHEN SHOULD WOOD CRACKS BE A CONCERN?

Most of the wood splits will never become large enough to affect the reliability and strength of our products, however, there can be rare cases where splits can occur. This happens when a crack develops past the halfway point from the timber, splitting it into two separate pieces.

Feel free to contact us with detailed pictures of your product so we can assess and ensure that your playground remains safe.

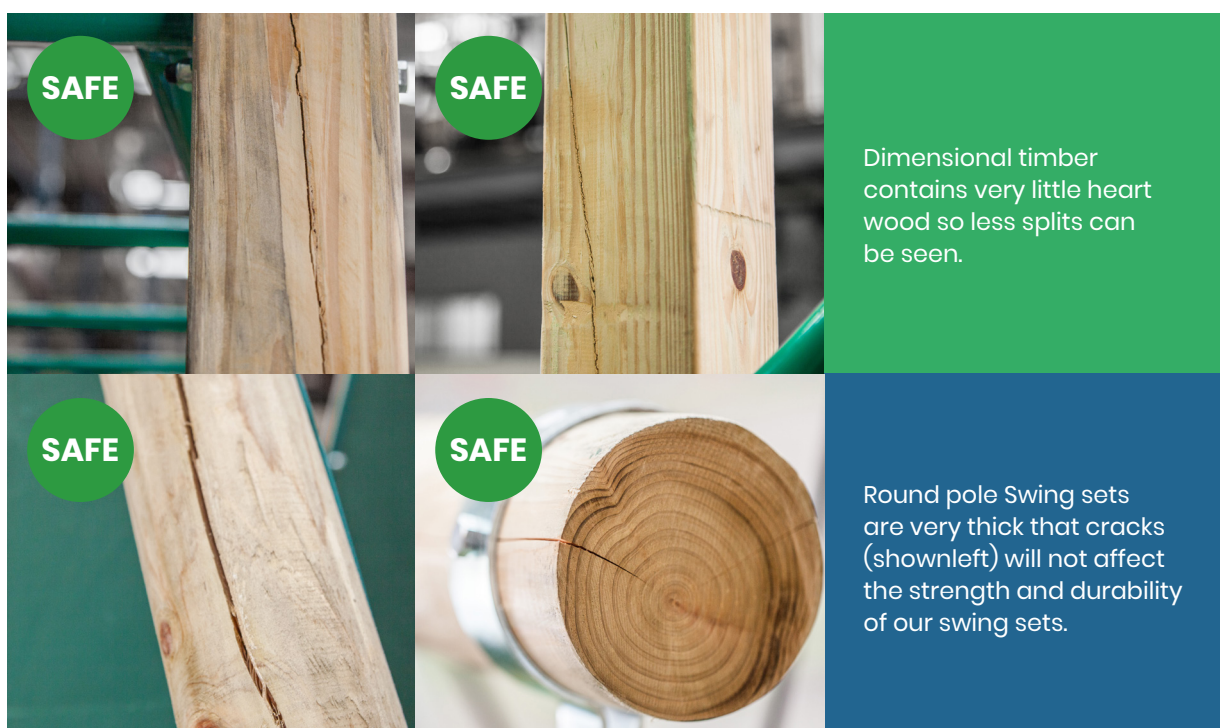

### 3. Mould and Mildew

Protecting against mould and mildew on your outdoor equipment is an important step in maintaining your backyard. Mould may develop for several reasons, such as certain weather conditions, improper drainage or infrequent usage. Here we'll share our tips for keeping your outdoor areas free of mould and mildew so that you can enjoy your backyard with peace of mind.

Once you spot mould on your equipment, it's important to start clearing it up straight away. The first step is to scrub it off with soap and water, until all the visible signs of mould are removed. It's important to remember however, that just because you can't see it anymore doesn't mean it's gone.

The next step is to kill off the remaining mould so that it doesn't grow back. Here are a few options, but keep in mind these should be used independently. Don't mix or combine these methods at the same time.

#### Mould Killer or Removal Spray

You can purchase off-the-shelf removal sprays that destroy mould either indoors or outdoors. For these products, make sure to follow the product instructions as well as wearing protective gloves to avoid contact with skin.

## Bleach

A solution of bleach and water can also be highly effective in killing mould. For this method, mix the water and bleach on a 1 to 1 ratio, then use a sponge or brush to scrub the affected area. You can also use a higher concentration of bleach for spot treating. After bleach treatment, make sure to rinse off your equipment and allow to dry.

## Vinegar

If mould is still lingers after applying bleach or a mould spray, vinegar will be an effective option for removing stubborn remnants. Vinegar will kill most types of mould and is best for nonporous materials like hard plastics or metal. The best method is to fill a spray-bottle with undiluted white vinegar of at least 5% acetic acid. Spray the affected area, then let sit for around an hour. Make sure to thoroughly rinse off afterwards.

For wooden equipment, you can add a coat of paint or stain after it has thoroughly dried.

Some people may find that mould keeps resurfacing after cleaning on certain areas. This can be due to a few reasons, such as poor sunlight. Areas without direct sun are more likely to become damp and take longer to dry off after rain. Consider removing obstacles or rearranging your equipment so that it receives more sunlight, which will also help to kill the mould once it develops.

---

## VII. WARRANTY

### AUSTRALIAN CONSUMER LAW

Many of our products come with a guarantee or warranty from the manufacturer. In addition, they come with guarantees that cannot be excluded under the Australian Consumer Law. You are entitled to a replacement or refund for a major failure and compensation for any other reasonably foreseeable loss or damage.

You are entitled to have the goods repaired or replaced if the goods fail to be of acceptable quality and the failure does not amount to a major failure. Full details of your consumer rights may be found at [www.consumerlaw.gov.au](http://www.consumerlaw.gov.au).

Please visit our website to view our full warranty terms and conditions:

[www.lifespankids.com.au/Warranty-Policy-Kids](http://www.lifespankids.com.au/Warranty-Policy-Kids)

### WARRANTY AND SUPPORT

Any claim against this warranty must be made through your original place of purchase. Proof of purchase is required before a warranty claim may be processed. If you have purchased this product from the Official Lifespan Kids website, please visit [www.lifespankids.com.au/warranty-form](http://www.lifespankids.com.au/warranty-form)

For support outside of warranty, if you wish to purchase replacement parts or request a repair or service, please visit [www.lifespankids.com.au/warranty-form](http://www.lifespankids.com.au/warranty-form) and fill in our Repair/Service Request Form or Parts Purchase Form.



