



LIFESPAN KIDS

# USER MANUAL

## Daintree Monkey Bar & Swing Set



Find the Digital  
Manual Online

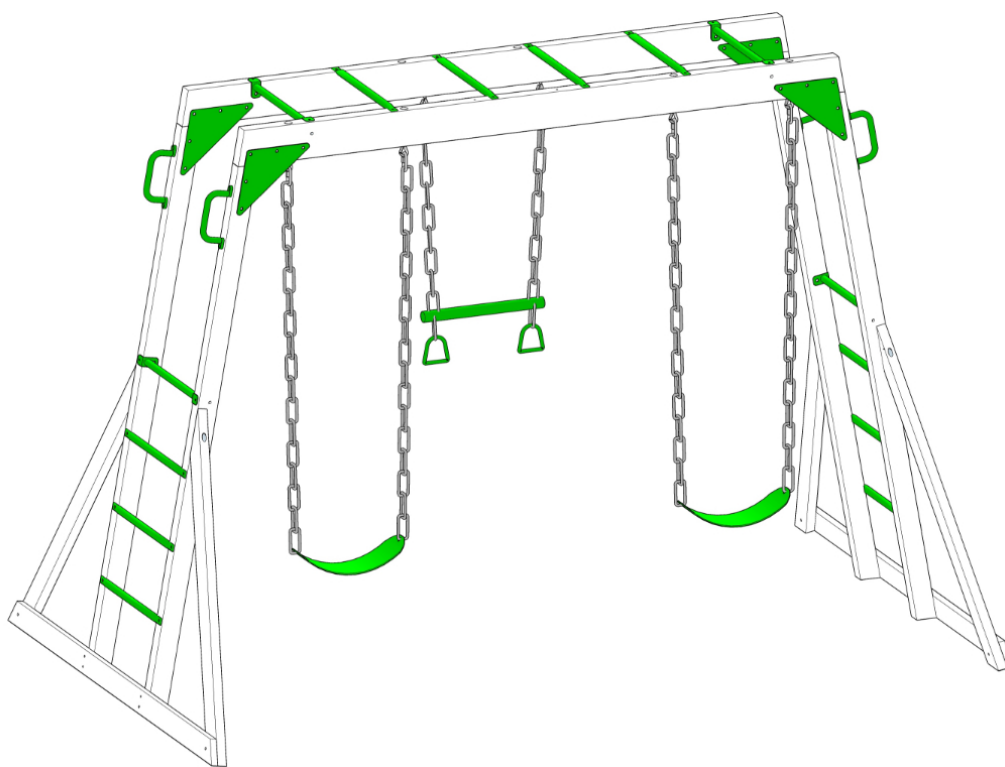

### WARNING

- DO NOT PLAY THE MONKEY BAR AND SWINGS/TRAPEZE AT THE SAME TIME.
- DO NOT ENTER THE MONKEY BAR WHEN KIDS ARE PLAYING ON THE FLEXIBLE SWINGS AND TRAPEZE BAR.
- THE FLEXIBLE SWINGS AND TRAPEZE BAR HAVE TO BE REMOVED BEFORE CHILDREN USE THE MONKEY BARS.

NOT SUITABLE FOR CHILDREN UNDER 3 YEARS .  
FOR OUTDOOR DOMESTIC USE ONLY.

#### MAX USER:

MONKEY BAR - ONLY 1 USER ALLOWED  
SWING AND TRAPEZE FUNCTION - ONLY 1  
USER ALLOWED FOR EACH FUNCTION.

#### MAX USER WEIGHT:

50KG FOR MONKEY BAR  
50KG FOR SWING SEAT AND TRAPEZE



**WARNING:** This instruction manual must be kept. Residential home and outdoor use only. This unit is not intended for public use. Don't install over concrete asphalt or any other hard surface.

### IMPORTANT:

This product may contain sharp points and small parts prior to assembly. The owner's manual contains safety, assembly, use and maintenance instructions. This product must be assembled by an adult who has read and understood these instructions. Keep the packaging away from children and dispose of all packaging before use.

*For the installer and your children's safety, it is important to fully read and understand the instructions and safety hazards before commencing the assembly of the product.*

### NOTE:

This manual should not be used to guide your purchasing decision. Your product, and the contents inside its carton, may vary from what is listed in this manual. This manual may also be subject to updates or changes. Updated manuals are available through our website at [www.lifespankids.com.au](http://www.lifespankids.com.au).

---

# TABLE OF CONTENTS

<b>I. GENERAL SAFETY INSTRUCTIONS</b>	3
1.1 Danger for Children	3
1.2 Risk of Injuries	3
1.3 Product Damage	3
1.4 Assembly Advice	4
<b>II. IMPORTANT SAFETY INSTRUCTIONS</b>	5
<b>III. WOOD ADVICE</b>	11
<b>IV. ASSEMBLY INSTRUCTIONS</b>	12
<b>V. CLEANING</b>	22
<b>VI. WARRANTY</b>	22

---

# I. GENERAL SAFETY INSTRUCTIONS

This product is intended for outdoor domestic use only.

## 1.1 DANGER FOR CHILDREN



**WARNING:** No eating while using the product.

- Children do not recognize potential dangers from this product. The product must be stored out of reach of children and pets.
- This product may only be used with adult supervision at all times.
- The packaging material is not suitable for children due to choking and suffocation hazards.

## 1.2 RISK OF INJURIES

- Do not use the product if it is damaged or defective. If it is damaged or defective, please contact a qualified technician.
- Check the product before each use. Defective parts must be changed immediately as they can impair the function and the safety of the product.
- No more than one person to use the product at the same time.
- Use the product only on even and non- slipping surfaces. Never use it near water and keep sufficient space around for safety.
- Beware of moving parts such as the springs or elastics, which could catch your arms and legs. Do not place any objects or body parts in the product's openings.

## 1.3 PRODUCT DAMAGE

- Do not make alterations to the product. Only use original spare parts. Qualified technicians should only carry out repairs – improper repairs can lead to danger for the user. Use this product only as described in this manual.
- Protect the product against splashes, humidity, high temperature and direct sunlight.

## 1.4 ASSEMBLY ADVICE

- The assembly of the product must be done carefully and by an able-bodied adult. If in any doubt, ask a technically qualified person.
- Before you start with the assembly, read the instructions carefully.
- Remove all packaging materials and lay down all parts on an open space. This gives you an overview and simplifies the assembly procedure.
- Check with the parts list that all parts are available. Dispose of the packaging material when the assembly is completed.
- Beware that when using tools or doing technical work, there is always a risk of injuries. Assemble the product with care.
- Create a danger free environment; for example, do not let tools lay around the workspace. Store the packaging material in a way that cannot cause any danger.
- After installing the product according to the instruction manual, ensure all screws, bolts and nuts are correctly installed and tightened and that all joints are secure.
- Reasonable space must be kept between the product and possible sources of danger, such as other equipment swimming pools and fences.
- The product must be assembled correctly before use.
- Your play structure must be installed on a flat horizontal surface with a minimum of 2m between it and any structure or obstacle such as a fence, garage house, tree branches, clothesline, or electric cables.
- Modifications made to the original product shall be carried out according to the instructions of the manufacturer.
- The product must always be used in a well-lit area.
- Do not place anything under the product.
- Use gloves during assembly and disassembly.
- Outdoor products should be equipped with a device that in strong wind conditions avoid displacement due to wind (e.g. steel bars in the ground or loads like sandbag or water bags).
- In certain areas during winter, snow buildup and the low temperatures can damage the product. It is recommended to remove snow buildup and to store the product indoor.
- We strongly recommend visual inspections every 3 months to ensure the integrity of the entire product. Replace any parts as necessary.

### Tools you will need (Not Included)

To complete this procedure, you will need a Power Drill, a Phillips Head Bit, a Hammer, a Rubber Mallet, a Metric Socket Wrench Set, a Level, a Square, a Tape Measure and a Ladder (not pictured). Optional, you may need a Flathead Screwdriver.

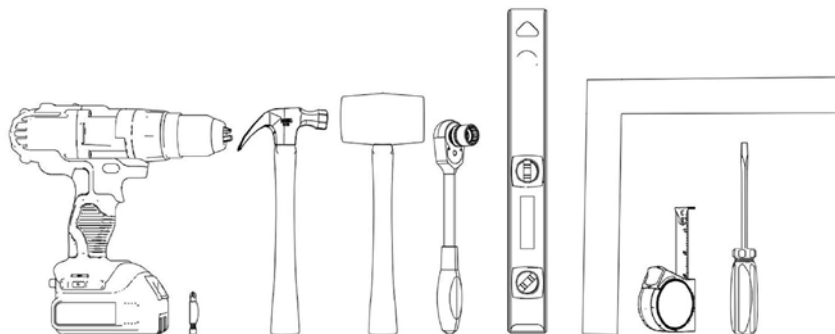

---

## II. IMPORTANT SAFETY INFORMATION

### **WARNING**

- To reduce the risk of serious injury or death, you **MUST** read and follow these instructions before assembly and before use.
- Continuous adult supervision is required.
- This unit is recommended for use by children 3-10 years of age.

- **RESIDENTIAL HOME USE ONLY.** This unit is not intended for public use. The manufacturer does not warranty this product if it is used for commercial purposes like daycare, schools, churches, nurseries, or parks.

- Children must not use this product prior to complete assembly and inspection by a competent adult. The unit must be fully assembled, properly installed and anchored prior to use.

a. Not suitable for children under 3 years.

b. Max User: when using Monkey Bar, only 1 user is allowed. Only 1 user each when using Swing seat and Trapeze.

c. Max User Weight: 50kg each for Monkey Bar, Swing Seat and Trapeze.

d. Max fall height: 2m

e. For outdoor domestic use only

### **SERIOUS HEAD INJURY HAZARD**

Installation over concrete, asphalt, dirt, grass, carpet, and other hard surfaces creates a risk of serious injury or death from falls to the ground. Install and maintain shock absorbing material under and around this unit as recommended in this manual.

### **COLLISION HAZARD**

Place this unit on level ground at least 6 Ft (2m) from any obstruction such as a garage, or house, fences, poles, trees, sidewalks, walls, landscape timbers, rocks, pavement, planters, garden borders, overhanging branches, laundry lines and electrical wires.

### **CHOCKING HAZARD/ SHARP EDGES & POINTS**

ADULT ASSEMBLY REQUIRED. This product contains small parts and part with sharp edges and points. Keep parts away from children until fully assembled.

### **STRANGULATION HAZARD**

- NEVER allow children to play with ropes, clotheslines, pet leashes, cables, chains, cord-like items or items with a cord or strap when playing on this unit. DO NOT attach these items or similar to this unit.

- MUST wear appropriate clothing and avoid loose fitting clothes while playing on this unit. Children should wear well-fitting clothing and closed toe shoes.

### **TIP OVER HAZARD**

Choose a level surface for this equipment. This can reduce the likelihood of the unit tipping over and loose-fill material from washing away during heavy rains. DO NOT allow children to play on this unit until assembly is complete and the unit is properly anchored.

## INSTRUCTIONS FOR SAFE USE

### **WARNING**

User safety is our top concern, Read and understand the following statements and warnings to reduce the likelihood of serious or fatal injury.

#### **Review this information with your child and any other users.**

1. ON-SITE CONTINUOUS ADULT SUPERVISION IS REQUIRED FOR CHILDREN OF ALL AGES. Most serious injuries and deaths on playground equipment result when children are playing unsupervised.

This product meets all applicable safety standards. Complying with all warnings and important information in this manual will reduce the risk of serious or fatal injury to children playing on this unit. Review all warnings and play information regularly with any child using this unit. Ensure children fully understand and follow these instructions.

2. This unit is designed for a specific number of users whose combined weight should not exceed the capacity limitations for 50kg per child with a maximum of 4 children.

3. DO NOT walk close to, in front of, behind or between moving swings or other moving equipment.

4. DO NOT stand on swings. Only sitting is permitted.

5. DO NOT twist the chains and ropes of the swings or loop them over the support bar as this may reduce the strength of the chain or rope.

6. DO NOT get off swings or other playground equipment while in motion.

7. DO NOT push the empty swing seat to prevent them from swinging back and causing possible injury.

8. Children should sit with full weight in the center of the swings to prevent erratic swing motions and falling off the swings.

9. DO NOT allow children to use the equipment in a manner other than intended.

10. When wet equipment will be slippery. Wipe dry before use.

11. DO NOT jump from the deck or any part of the unit. Always use the ladders and ramps. Standing on or jumping from elevated surfaces can be dangerous.

12. DO NOT crawl or climb on the roof.

13. Verify that any suspended climbing rope, chain, or cable is secured at both ends and that it cannot be looped back on itself and create an entanglement hazard.

14. MINIMUM CLEARANCE BETWEEN SWINGS AND GROUND: 14 in. (350mm).

15. DO NOT attach items to the unit that are not specifically designed for use with the unit such as but not limited to: jump ropes, clothesline, pet leashes, cables, and chains, as they may cause strangulation hazard.

16. Never add extra length to chain to rope. The chains or ropes provided are the maximum length designed for the swing elements.

17. DO NOT wrap legs around the swing chain.

18. DO NOT slide down the swing chain.

19. On hot days, check the plastic components to ensure they are not too hot for use. Cool the plastic with water and wipe down before use.

## Consumer Information Sheet for Playground Surfacing Materials

The US Consumer Product Safety Commission (CPSC) estimates that about 100 000 playground equipment-related injuries resulting from falls to the ground surface are treated annually in US hospital emergency rooms. Injuries involving this hazard pattern tend to be among the most serious of all playground injuries, and have the potential to be fatal, particularly when the injury is to the head. The surface under and around playground equipment can be a major factor in determining the injury-causing potential of a fall. It is self-evident that a fall onto a shock-absorbing surface is less likely to cause a serious injury than a fall onto a hard surface. Playground equipment should never be placed on hard surfaces, such as concrete or asphalt, and while grass may appear to be acceptable, it may quickly turn to hard-packed earth in areas of high traffic. Shredded bark mulch, wood chips, tine sand or the gravel are considered to be acceptable shock absorbing surfaces when installed and maintained at a sufficient depth under and around playground equipment.

Table B.1 lists the maximum height from which a child would not be expected to sustain a life-threatening head injury in a fall on to four different loose-fill surfacing materials if they are installed and maintained at depths of 150 mm, 225 mm and 300 mm.

**TABLE B.1:** Fall height in millimetres from which a life-threatening head injury would not be expected.

TYPE OF MATERIAL	DEPTH OF SURFACING MATERIAL		
	150mm	225mm	300mm
Double Shredded Bark Mulch	1800	3000	3300
Wood Chips	1800	2100	3600
Fine Sand	1500	1500	2700
Fine Gravel	1800	2100	3000

However, it should be recognised that all injuries due to falls cannot be prevented, no matter what surfacing material is used.

It is recommended that a shock absorbing material extend a minimum of 1800mm in all directions from the perimeter of stationary equipment such as climbing frames and slides. However, because children may deliberately jump from a moving swing, the shock absorbing material should extend in the front and rear of a swing a minimum distance of twice the height of the pivot point measured from a point directly beneath the pivot on the supporting structure.

This information is intended to assist in comparing the relative shock-absorbing properties of various materials. No particular material is recommended over another. However, each material is only effective when properly maintained. Materials should be checked periodically and replenished to maintain correct depth as determined necessary for the equipment in question. The choice of a material depends on the type and height of the playground equipment, the availability of the material in a particular area, and its cost.

## UNIT POSITIONING

- PLEASE REFER TO CRITICAL FALL HEIGHT INFORMATION
- This unit should be installed on a level surface by an ADULT with an ADULT ASSISTANT (if needed). Place the unit on a flat area to minimize ground preparation.
- Choose a level location for this unit to reduce the likelihood of the play set tipping over and loose-fill surfacing materials washing away during heavy rains.
- Place the unit no less than 6Ft (2m) from any structure or obstruction, such as fence, garage, house, overhang, branches, laundry lines, or electrical wires.
- Provide enough room so that children may play on this unit safely. For example, for structures with multiple play activities, a slide should not exit in front of a swing.
- Place this unit where adults are easily able to watch children play.
- Create a play area free of obstacles that could cause injuries – such as low hanging tree branches, overhead wires, tree stumps or roots, large rocks, bricks, and concrete.
- Do not build this unit on top of surfacing material.
- Locate bare metal platforms and slides out of direct sunlight to reduce the likelihood of serious burns.
- For to-fro swings, extend protective surfacing in front of and behind the swing to a distance equal to twice the height of the top of the bar from which the swing is suspended.

## VERTICAL HEIGHT

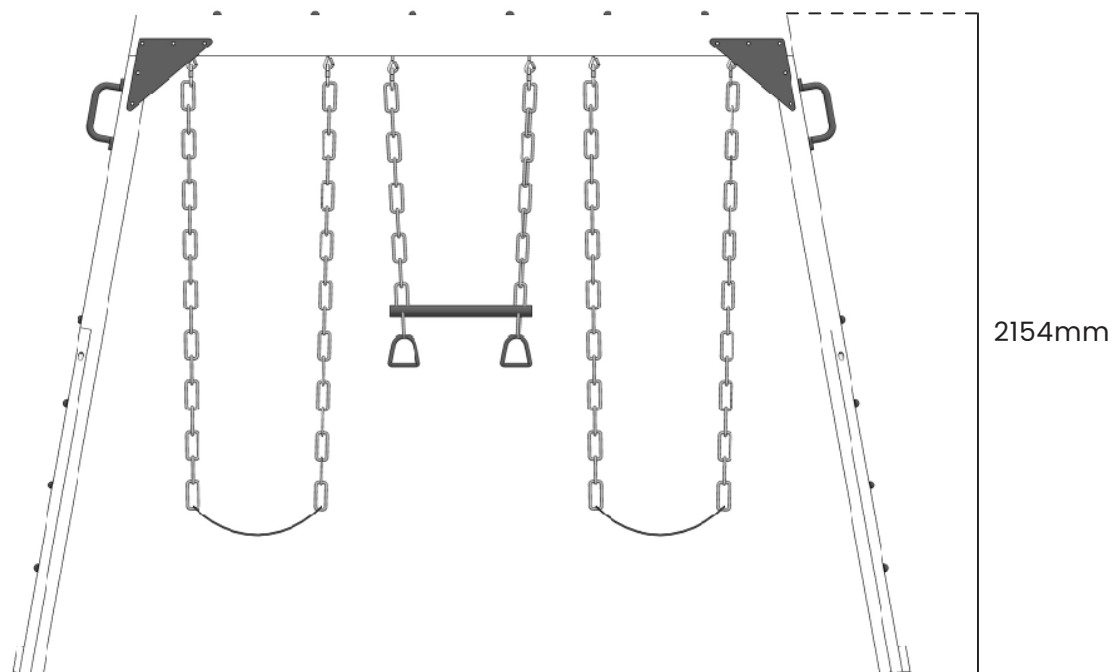



## SAFETY SURFACING REQUIREMENTS

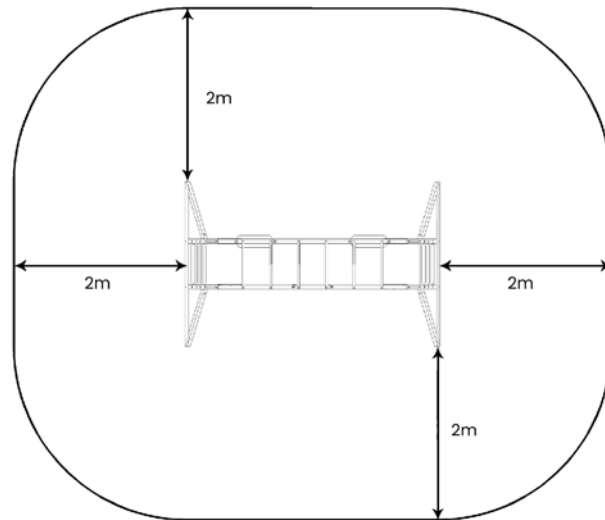

## IMPORTANT SAFETY INFORMATION - MAINTENANCE

ONLY REPLACE DAMAGED PRODUCT ACCORDING TO THE MANUFACTURER'S INSTRUCTIONS  
If checks are not carried out, the equipment could overturn or become a hazard.

### At The Beginning Of Each Play Season

- Tighten all hardware, but do not over-tighten to prevent splintering.
- Lubricate all metallic moving parts with silicon oil.
- Check that swing hanger bolts are secure and tight. Quick clips should be completely closed, and threaded clips screwed tight. Ropes should be secure at both ends so they cannot loop back and create an entrapment.
- Check all protective coverings on bolts, pipes, edges, and corners. Replace if they are loose, cracked or missing.
- Check for sharp edges or protruding screw threads. Add washers if required.

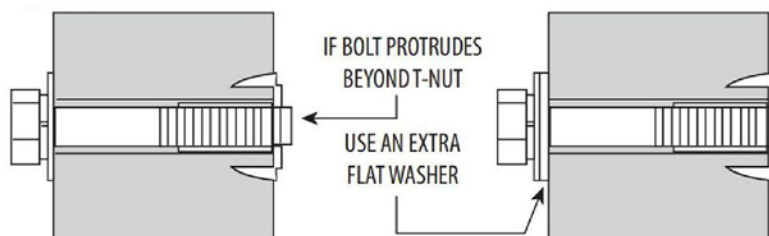

- Check ground stakes for looseness, damage, or deterioration. Firmly anchor unit to the ground during use. Re-secure or replace if necessary.
- Check all moving parts including swing seats, ropes, cables and chains for wear, rust, or other deterioration. Replace as needed.
- Check metal for rust. If found sand and repaint using a non-lead-based paint.

- Check all wood pieces for deterioration and splinters. Sand down splinters and replace deteriorating wood.
- Reinstall any plastic parts, such as swing seats or any other items that were removed for the cold season.
- Rake and check depth of loose fill protective surfacing materials to prevent compaction and to maintain appropriate depth. Replace as necessary.

### **At the End of each Play Season**

\*Or when the temperature falls below 0° Celsius.

- Remove plastic swing seats and other items as specified by the manufacturer and take indoors. Plastic components may become more brittle in wintry conditions.
- Rake and check depth of loose fill protective surfacing materials to prevent compaction and to maintain appropriate depth. Replace as necessary.

### **Twice a Month During Play Season**

- Tighten all hardware, but do not over-tighten to prevent splintering.
- Check all protective coverings on bolts, pipes, edges, and corners. Replace if they are loose, cracked or missing.
- Check for sharp edges or protruding screw threads. Add washers if required.
- Rake and check depth of loose fill protective surfacing materials to prevent compaction and to maintain appropriate depth. Replace as necessary.

### **Once a Month During Play Season**

- Check all moving parts including swing seats, ropes, cables, and chains for wear, rust, or other deterioration. Replace as needed.
- Lubricate all metallic moving parts per manufacturer's instructions.

### **Additional Maintenance**

- Check the swing beam and hardware every two weeks due to wood expansion and contraction. It is particularly important that this procedure be followed at the beginning of each season.
- Inspect wood parts monthly. The grain of the wood sometimes will lift in dry season causing splinters to appear. Light sanding may be necessary to maintain a safe play environment. Treat your unit with stain regularly to help prevent severe splitting and other damage.
- A waterborne transparent stain has been applied to your unit. Once or twice a year, depending on your climate conditions, you must apply some protection (sealant) on your unit. Prior to the application of the sealant, lightly sand any rough spots on your unit.

### **Please note this is a requirement of your warranty.**

- Assembling and maintaining the unit on a level surface is very important. As your children play, your unit will slowly dig its way into the soil. And it is very important that it settles evenly. Make sure the unit is level once each year or at the beginning of each play season.

---

### III. WOOD ADVICE

Our products are manufactured from premium timber. Great care is taken in selecting, machining, and treating the timber before it is sold to you.

1. Inspect wood parts monthly. The grain of the wood sometimes will lift in dry periods causing splinters to appear. Light sanding may be necessary to maintain a safe environment. Treating your product with protection (sealant) after sanding will help prevent severe checking/splitting and other weather damage.
2. We have applied a waterborne translucent stain to your unit. This is done for colour only. Once or twice a year, depending on your climate conditions, you must apply some type of protection (sealant) to the wood of your unit. Prior to the application of sealant, lightly sand any "rough" spots on your set. Please note this is a requirement of your warranty.

Bear in mind that timber is a natural product and may experience changes throughout the course of its life. It may:

- Develop opening/checks (splits, gaps, slits, apertures, cracks) along the line of the grain due to moisture & temperature changes.
- Colour fades as the timber reacts with sunlight.

#### MORE INFORMATION ON WOOD SPLITS

Each Lifespan Kids Timber Play Equipment is designed and built with tolerances to account for wood splits. All timber components are dried, temperature treated, and specified to the right size to ensure that the structural integrity of your play equipment will not be compromised from normal weathering. Most wood splits will never become large enough to affect the reliability and strength of your play equipment.

Please note that in dryer seasons, wood splits will appear more often, and often in wet seasons, you'll find that these wood splits will mostly disappear as the timber collects moisture and swells up. These are normal cycles

In the unlikely event you feel that a part has a possible fault in the timber, please contact Lifespan Kids immediately with pictures of the parts so they can be reviewed. Please refer to Page 15 to get in touch with us.



















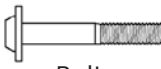

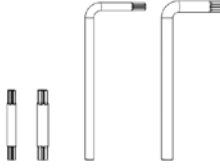

For more information: [www.lifespankids.com.au/natural-timber](http://www.lifespankids.com.au/natural-timber)

## IV. ASSEMBLY INSTRUCTIONS

### BOARD LIST

Unit:mm	Part Code	Quantity	Dimensions
	E1	x 1	2180 x 134 x 50
	E2	x 1	2180 x 134 x 50
	E3	x 4	2065 x 76 x 50
	E4	x 4	1325 x 86 x 35
	F1	x 2	1900 x 86 x 24

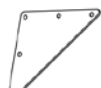
### PARTS LIST

<b>BM818</b> x 28  B-Nut 8x18mm	<b>N815</b> x 10  Nut 8x15mm	<b>AN8</b> x 6  A-Nut 8mm	<b>W12/28</b> x 6  Washer	<b>W10/18</b> x 4  Washer	
<b>M845</b> x 28  Bolt φ8mmx45mm	<b>M855</b> x 4  Bolt φ8mmx55mm	<b>SW50</b> x 8  Screw φ4x50mm	<b>M6SW35</b> x 20  Screw φ6x35mm	<b>M8SW35</b> x 16  Screw φ8x35mm	<b>M6SW55</b> x 12  Screw φ6x55mm
 Swing Hanger x 6	 (1) 6mm Star Bit, 8mm Star Bit, 6mm Allen Wrench, 8mm Allen Wrench	 Hand Grip x 4	 Trapeze x 1	 Swing x 2	<b>Tools you may need. Not Included.</b> • Drill/screw gun • No.17 wrench • Hammer • Level • Shovel/pick axe • Tape measure
 Metal Rung 651011 x 10	 Anchors x 8				
 Metal Board 651012x 8					
 Metal Rung 651034-L x 4					

# SET UP

## STEP 1

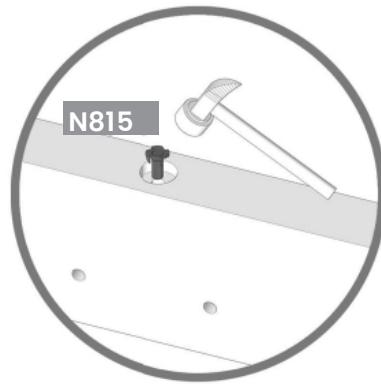

Insert the N815 into the beam by hammer

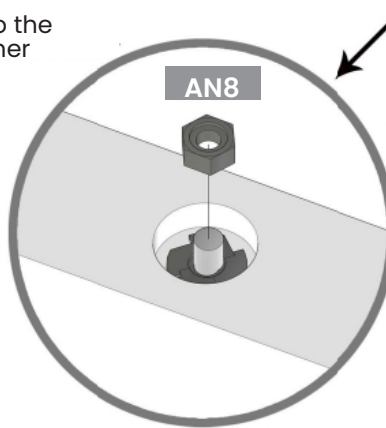
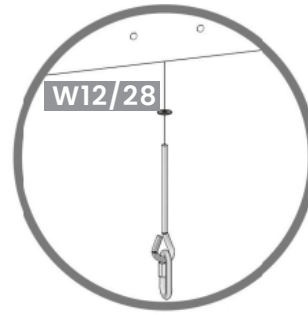

Insert the swing hanger into the beam and fixing them with nuts N815 as tight as possible

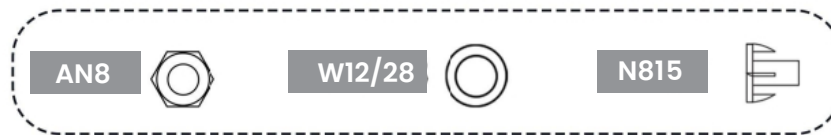

List	
Part NO.	Qty
E1	1
AN8	4
N815	4
W12/28	4
650007	4

Try to ensure that the distance between the two support feet is parallel.

# SET UP

## STEP 2

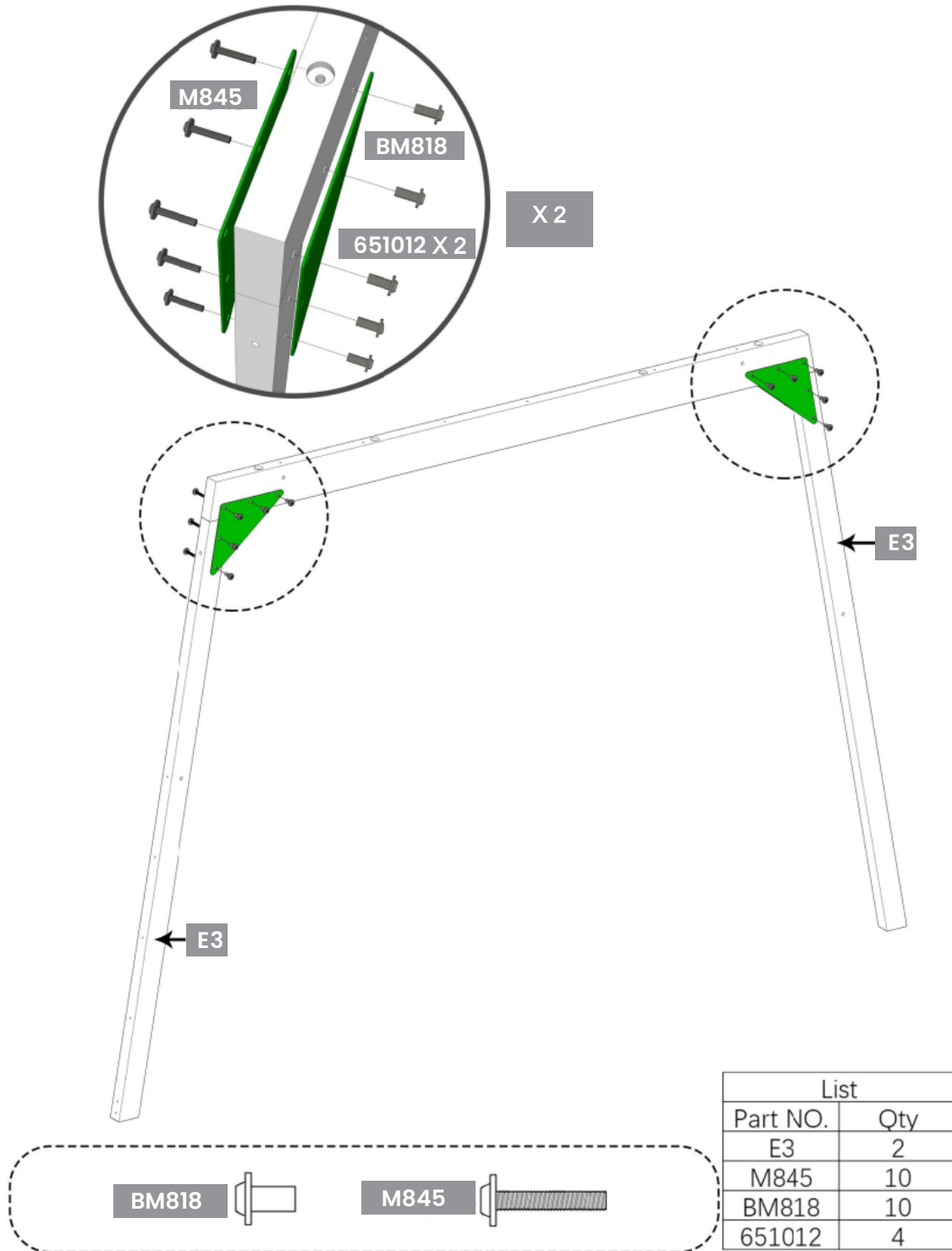

# SET UP

## STEP 3

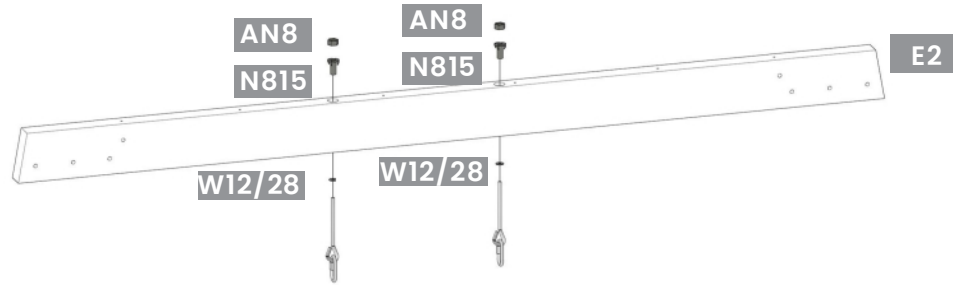

Swing Hanger x 2pcs

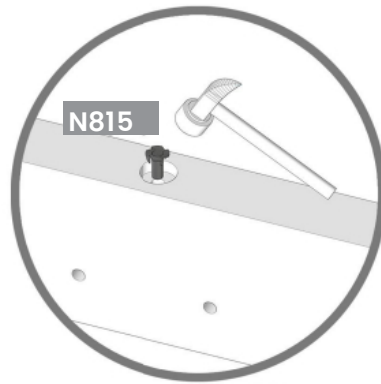

Insert the N815 into the beam by hammer

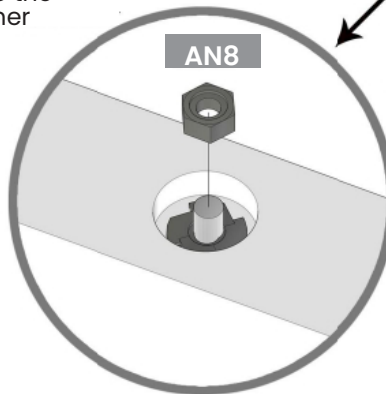
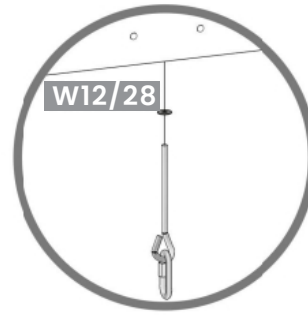

Insert the swing hanger into the beam and fixing them with nuts N815 as tight as possible



List	
Part NO.	Qty
E2	1
AN8	2
N815	2
W12/28	2
650007	2

Try to ensure that the distance between the two support feet is parallel.

# SET UP

## STEP 4

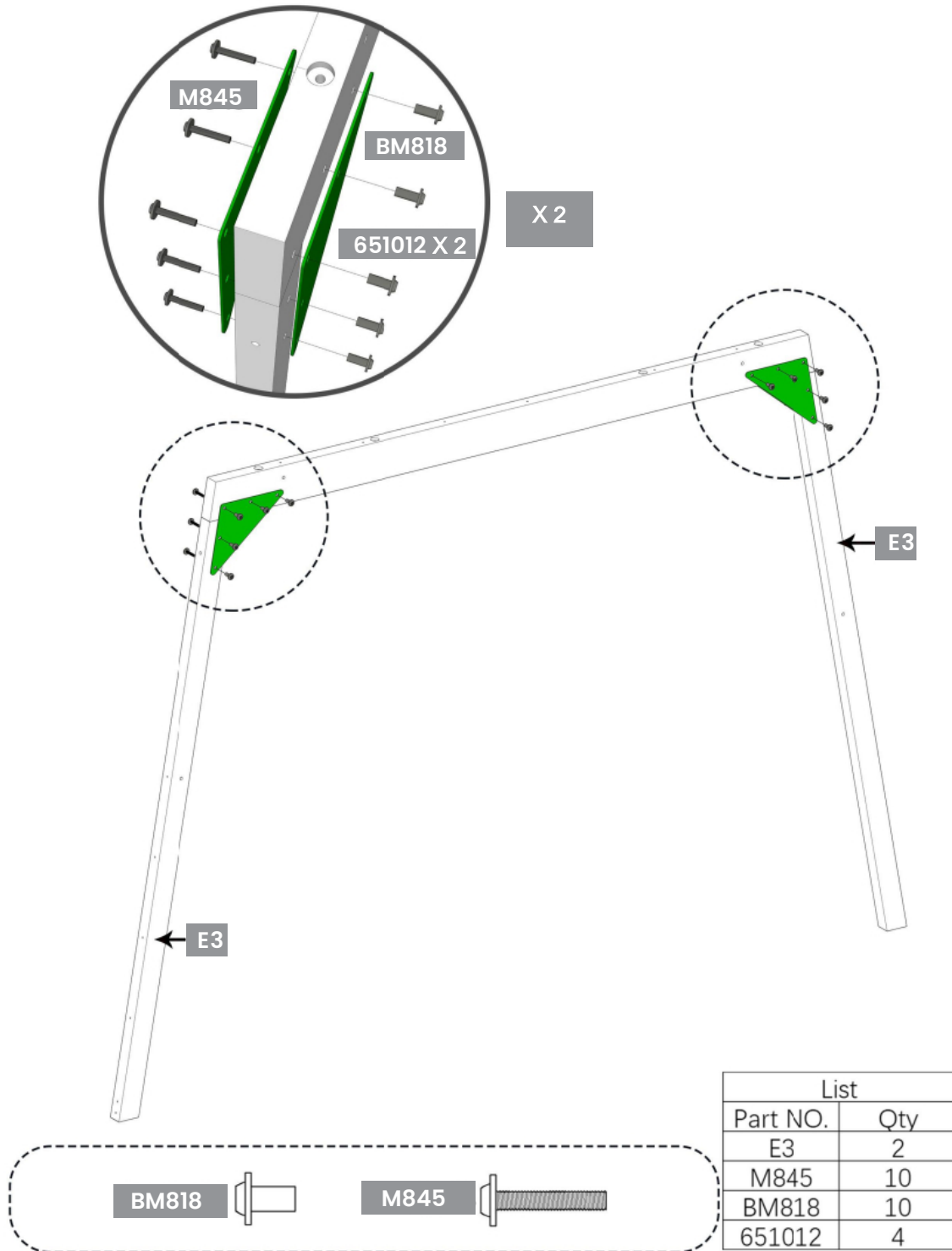



# SET UP

## STEP 5

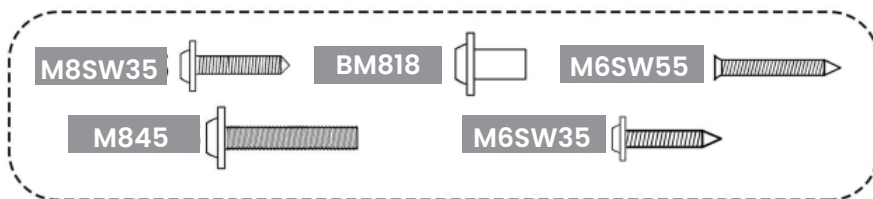
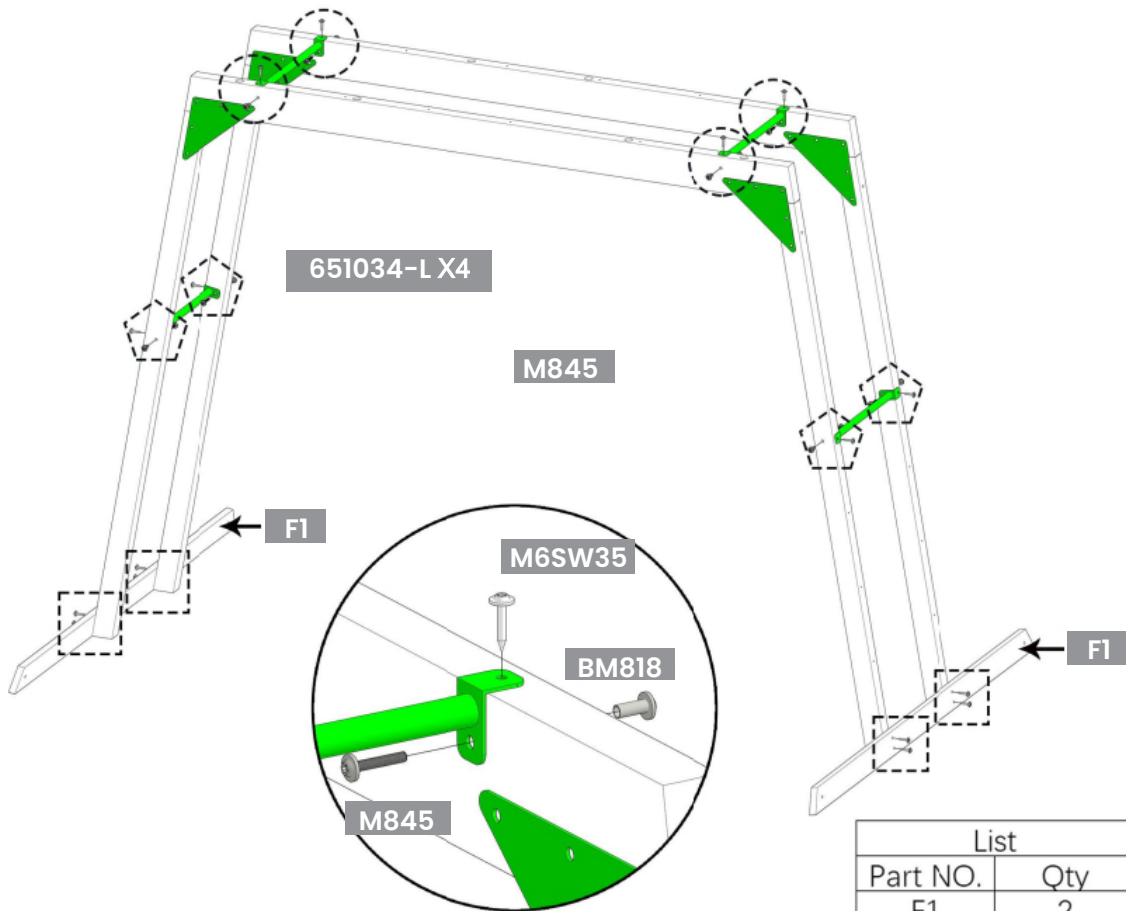
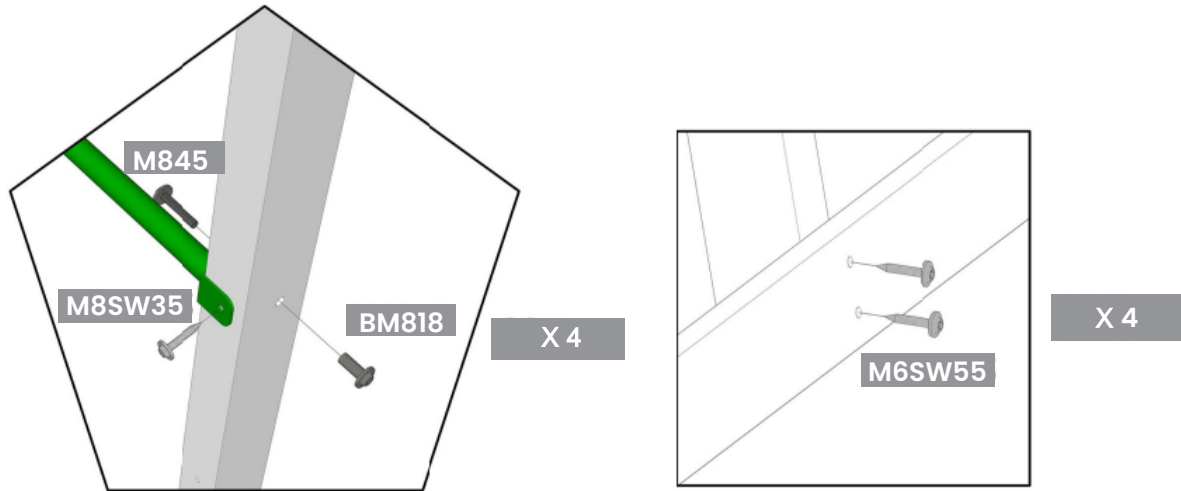

List	
Part NO.	Qty
F1	2
M845	8
BM818	8
M6SW55	8
M6SW35	4
651034-L	4
M8SW35	4

# SET UP

## STEP 6

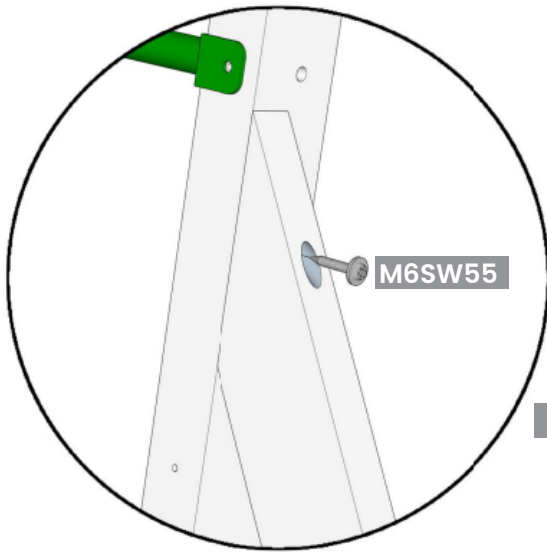

X4

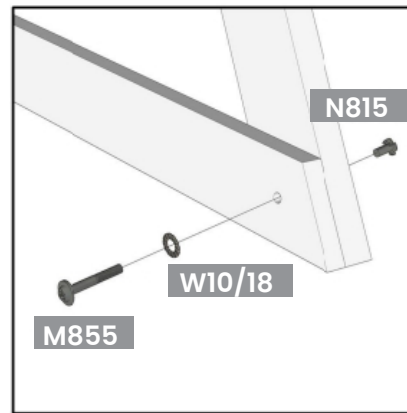

X4

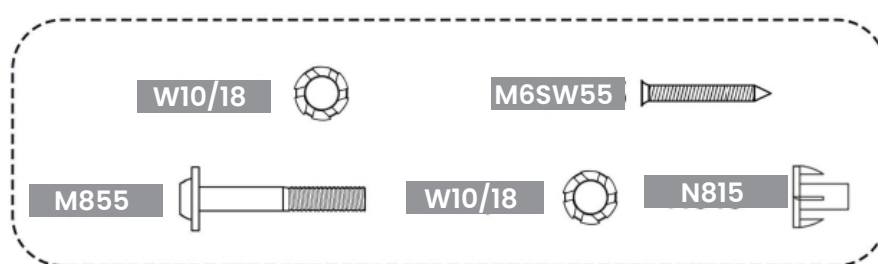
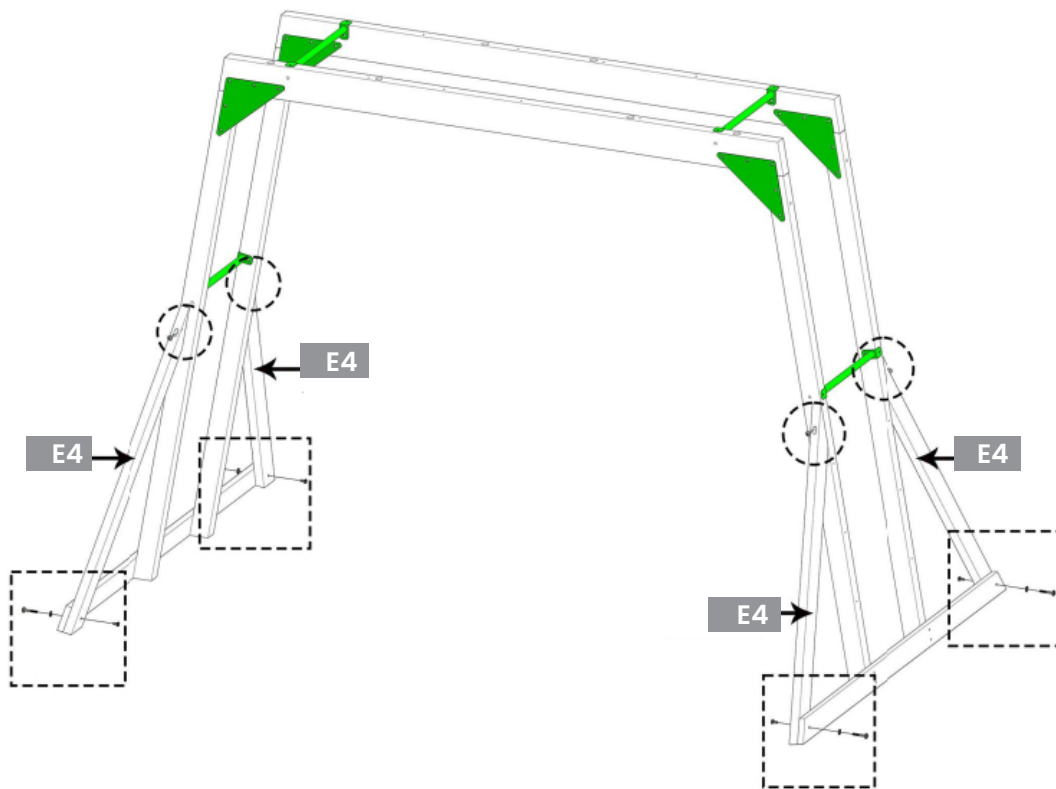

List	
Part NO.	Qty
E4	4
M6SW55	4
M855	4
W10/18	4
N815	4

# SET UP

## STEP 7

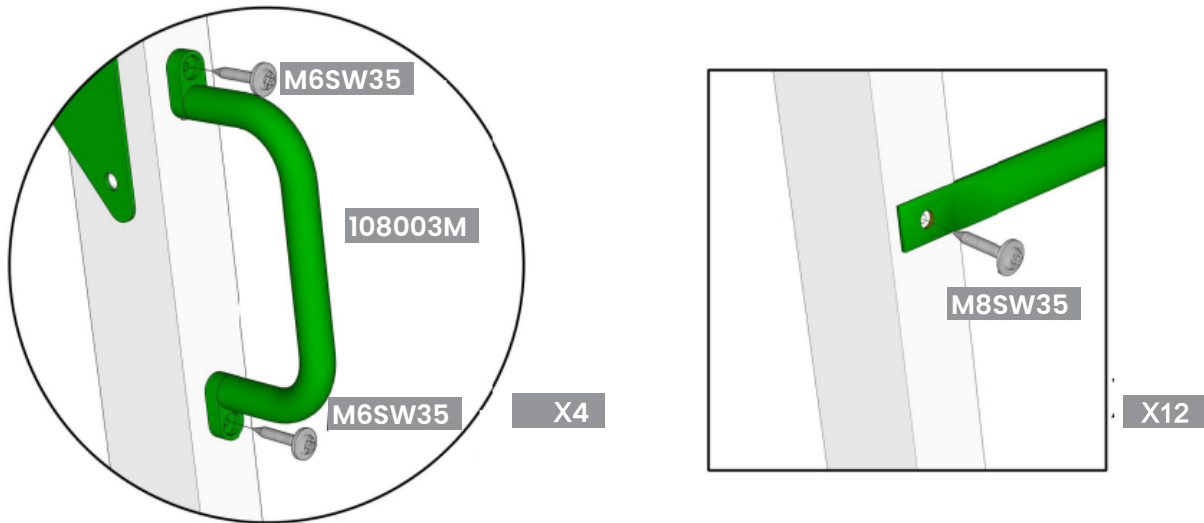

List	
Part NO.	Qty
M8SW35	12
651011	6
108003M	4
M6SW35	8

# SET UP

## STEP 8

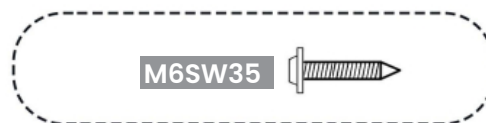
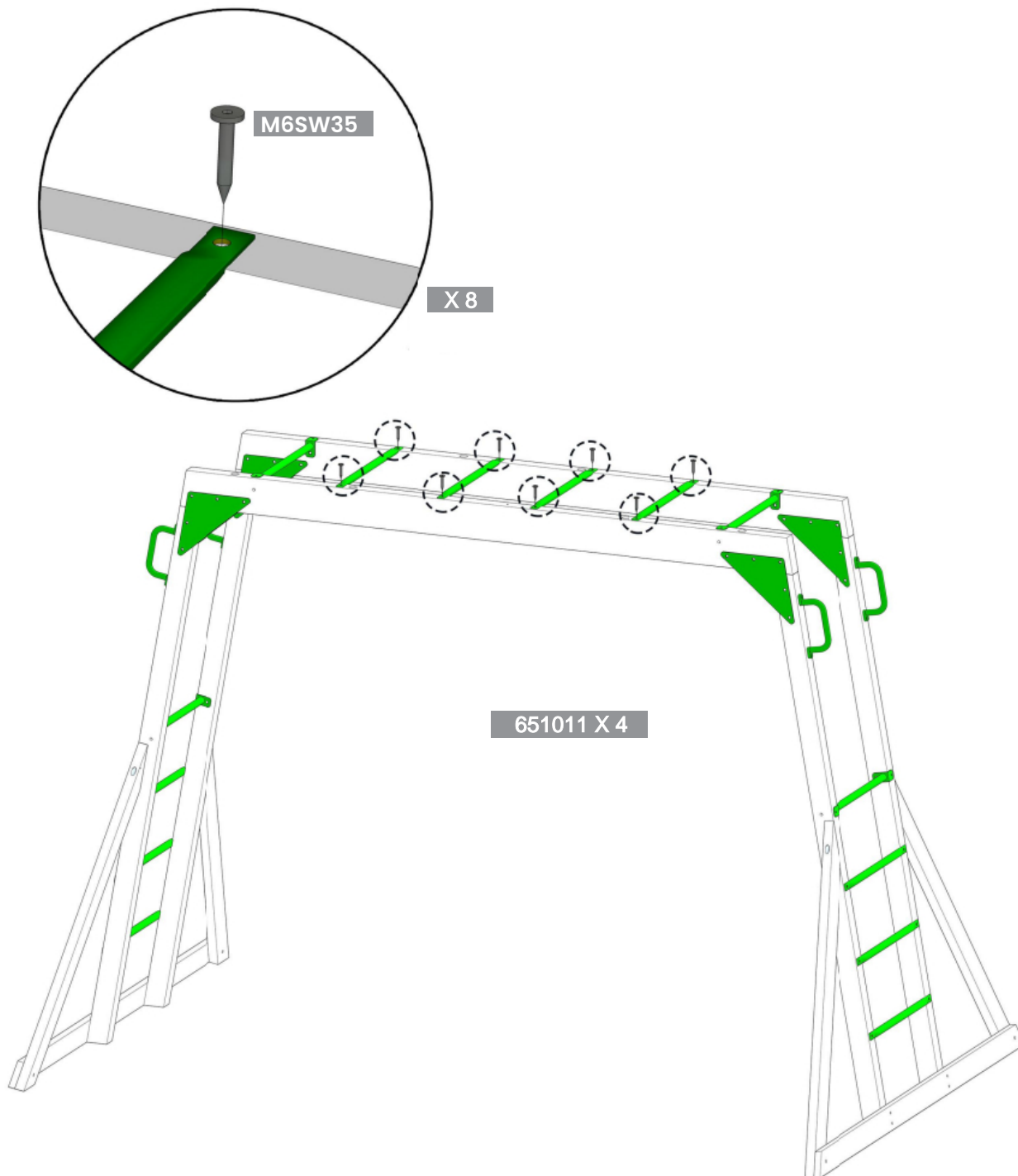

List	
Part NO.	Qty
M6SW35	8
651011	4

# SET UP

## STEP 9

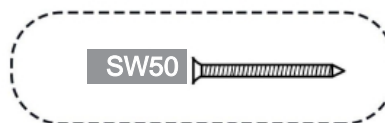
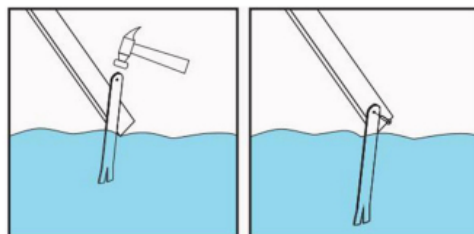
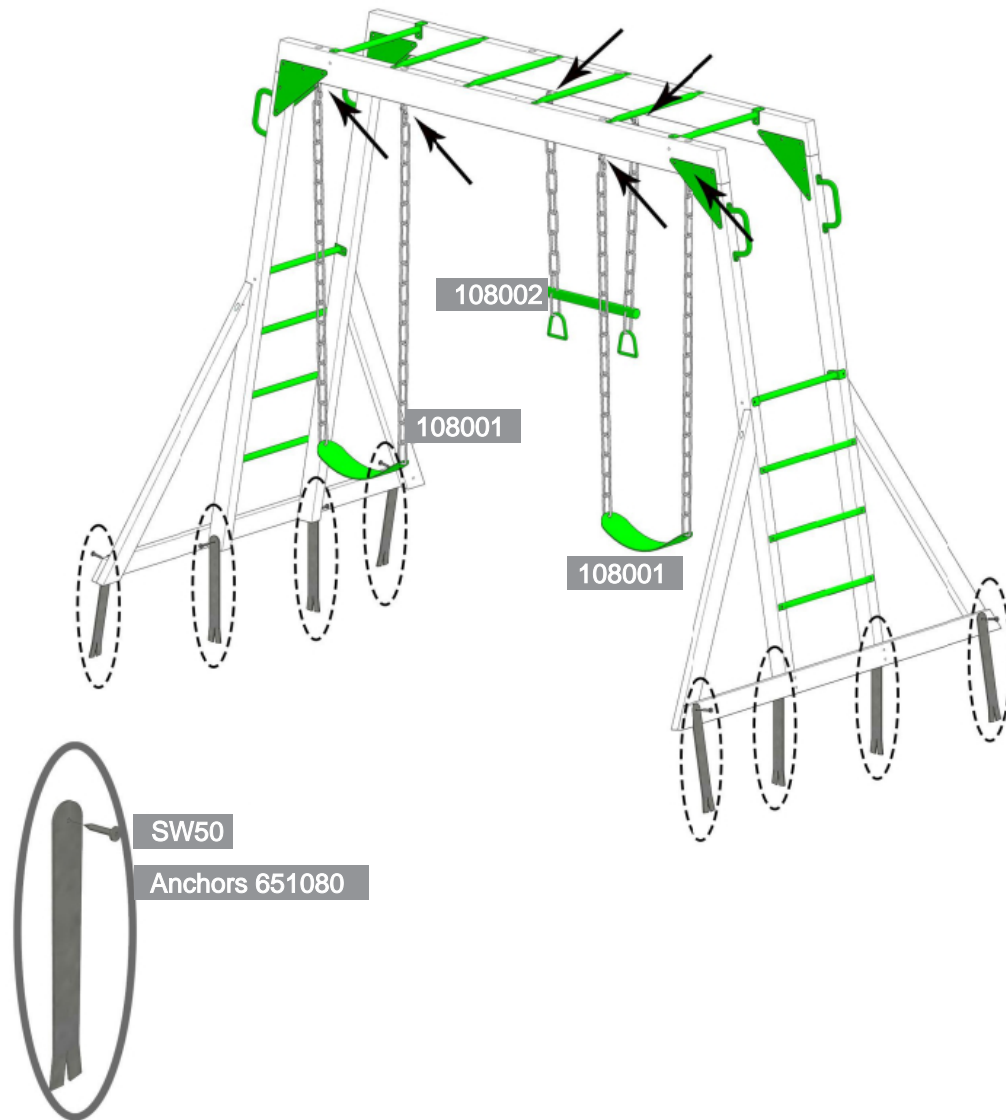

List	
Part NO.	Qty
SW50	8
651080	8
108001	2
108002	1

---

## V. CLEANING

Do not use any abrasive cleansers for the cleaning. Use a soft, damp cloth to eliminate dirt and dust.

---

## VI. WARRANTY

### AUSTRALIAN CONSUMER LAW

Many of our products come with a guarantee or warranty from the manufacturer. In addition, they come with guarantees that cannot be excluded under the Australian Consumer Law. You are entitled to a replacement or refund for a major failure and compensation for any other reasonably foreseeable loss or damage.

You are entitled to have the goods repaired or replaced if the goods fail to be of acceptable quality and the failure does not amount to a major failure. Full details of your consumer rights may be found at [www.consumerlaw.gov.au](http://www.consumerlaw.gov.au).

Please visit our website to view our full warranty terms and conditions:  
[www.lifespankids.com.au/Warranty-Policy-Kids](http://www.lifespankids.com.au/Warranty-Policy-Kids)

### WARRANTY AND SUPPORT

Any claim against this warranty must be made through your original place of purchase. Proof of purchase is required before a warranty claim may be processed. If you have purchased this product from the Official Lifespan Kids website, please visit [www.lifespankids.com.au/warranty-form](http://www.lifespankids.com.au/warranty-form)

For support outside of warranty, if you wish to purchase replacement parts or request a repair or service, please visit [www.lifespankids.com.au/warranty-form](http://www.lifespankids.com.au/warranty-form) and fill in our Repair/Service Request Form or Parts Purchase Form.



