



LIFESPAN KIDS

USER MANUAL

Kensington Play Centre Set with 2.2m Slide



Find the Digital
Manual Online

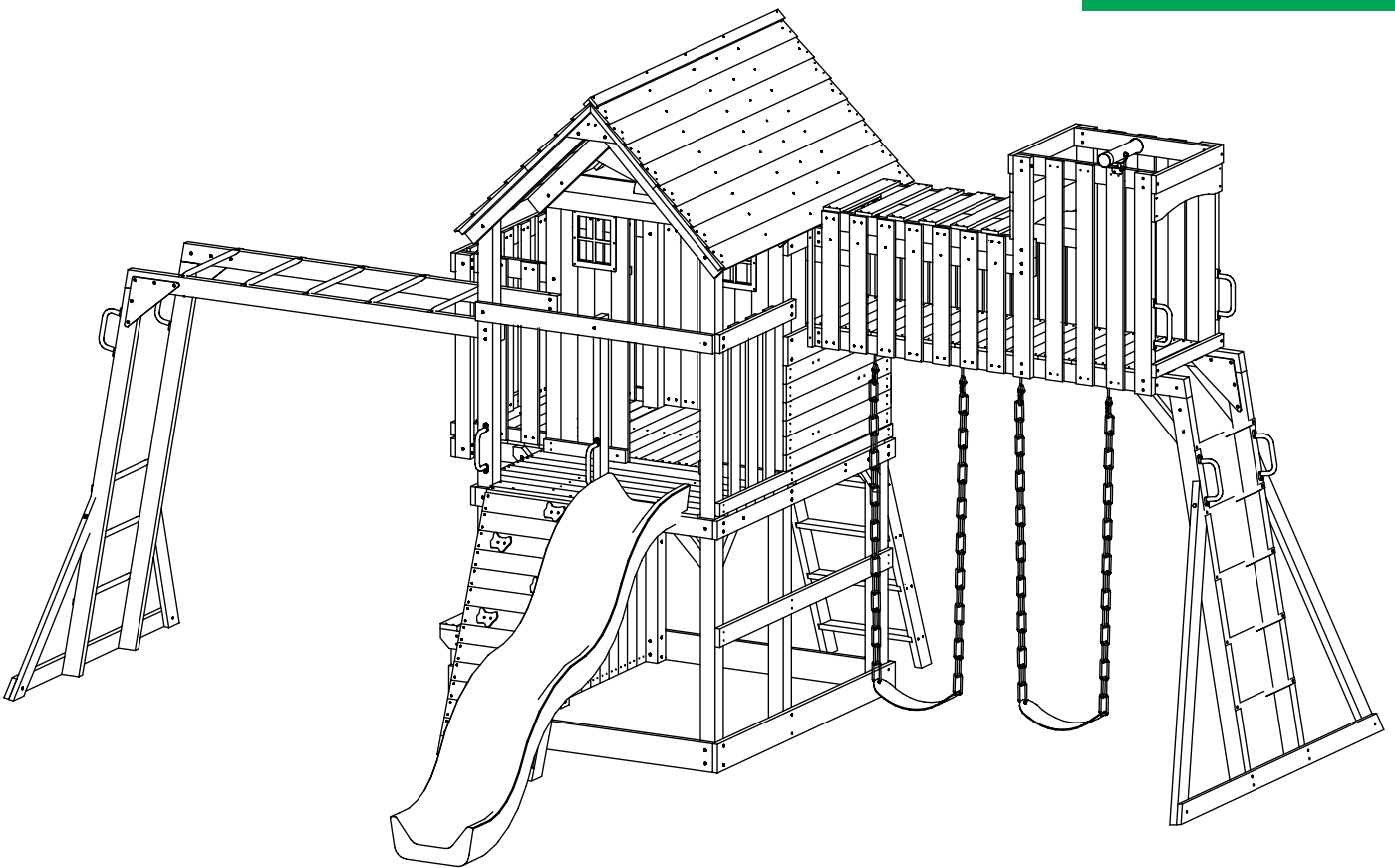

WARNING: The disassembled product may contain small parts which pose a choking hazard to children under 3.

IMPORTANT:

The owner's manual contains safety, assembly, use and maintenance instructions. This product must be assembled by an adult who has read and understood these instructions. Keep the packaging away from children and dispose of all packaging before use.

For the installer and your children's safety, it is important to fully read and understand the instructions and safety hazards before commencing the assembly of the product.

NOTE:

This manual should not be used to guide your purchasing decision. Your product, and the contents inside its carton, may vary from what is listed in this manual. This manual may also be subject to updates or changes. Updated manuals are available through our website at www.lifespankids.com.au.

TABLE OF CONTENTS

I. GENERAL SAFETY INSTRUCTIONS	3
1.1 Danger for Children	3
1.2 Risk of Injuries	3
1.3 Product Damage	3
1.4 Assembly Advice	4
II. SAFETY INSTRUCTIONS	5
IV. ASSEMBLY INSTRUCTIONS	7
V. MAINTENANCE	57
VI. WOOD ADVICE	58
VII. CLEANING	60
VIII. WARRANTY	61

I. GENERAL SAFETY INSTRUCTIONS

NOTE: This product is intended for outdoor domestic use only.

- Maximum Users: 9
- Maximum Fall Height: 2.0m
- A maximum of 68 kgs. per child is recommended for play activities designed for individual use.
- A maximum of 54 kgs. per child is recommended for play activities designed for multiple child use.

1.1 DANGER FOR CHILDREN



WARNING: No eating while using the product at the same time.

- Children do not recognize potential dangers from this product. The unassembled product must be stored out of reach of children and pets.
- This product may only be used with adult supervision at all times.
- The packaging material is not suitable for children due to choking and suffocation hazards.

1.2 RISK OF INJURIES

- Do not use the product if it is damaged or defective. If it is damaged or defective, please contact a qualified technician.
- Check the product before each use. Defective parts must be changed immediately as they can impair the function and the safety of the product.
- No more than one child at a time going down the slide and using the rock climbing wall.
- Use the product only on even and non-slipping surfaces. Never use it near water and keep sufficient space around for safety.
- Beware of moving parts such as the springs or elastics, which could catch your arms and legs. Do not place any objects or body parts in the product's openings.

1.3 PRODUCT DAMAGE

- Do not make alterations to the product. Only use original spare parts. Qualified technicians should only carry out repairs – improper repairs can lead to danger for the user. Use this product only as described in this manual.

1.4 ASSEMBLY ADVICE

- The assembly of the product must be done carefully and by an able-bodied adult. If in any doubt, ask a technically qualified person.
- Before you start with the assembly, read the instructions carefully.
- Remove all packaging materials and lay down all parts on an open space. This gives you an overview and simplifies the assembly procedure.
- Check with the parts list that all parts are available. Dispose of the packaging material when the assembly is completed.
- Beware that when using tools or doing technical work, there is always a risk of injuries. Assemble the product with care.
- Create a danger free environment; for example, do not let tools lay around the workspace. Store the packaging material in a way that cannot cause any danger.
- After installing the product according to the instruction manual, ensure all screws, bolts and nuts are correctly installed and tightened and that all joints are secure.
- Reasonable space must be kept between the product and possible sources of danger, such as other equipment swimming pools and fences.
- The product must be assembled correctly before use.
- Your play structure must be installed on a flat horizontal surface with a minimum of 2m between it and any structure or obstacle such as a fence, garage house, tree branches, cloths lines, or electric cables.
- Modifications made to the original product shall be carried out according to the instructions of the manufacturer.
- The product must always be used in a well-lit area.
- Do not place anything under the product.
- Use gloves during assembly and disassembly.
- Outdoor products should be equipped with devices to prevent displacement in strong wind conditions (e.g. steel bars in the ground or loads like sandbag or water bags).
- In certain areas during winter, snow buildup and the low temperatures can damage the product. It is recommended to remove snow buildup and to store the product indoors.
- We strongly recommend visual inspections every 3 months to ensure the integrity of the entire product. Replace any parts as necessary.

II. SAFETY INSTRUCTIONS

- The safety instructions of the product should always be considered and obeyed.
- Using this product incorrectly may result in permanent injury such as paralysis, or even death. Falling off the product may lead to injuries, particularly to the back, neck or head.
- No clothes with hooks or loose parts should be worn or carried during product usage in order to avoid hooks getting caught and causing injury.
- Strong winds can result in the product being blown away or damaged. If strong winds are predicted, the product must be disassembled and moved to a sheltered area or sufficiently anchored down.
- Moving the product whilst assembled may affect the integrity of the frame. Should it be necessary to move the product, please consider the following:
 1. Force to be evenly spaced around the frame to lift the product off the ground.
 2. The product must be carried horizontally.
 3. Use caution whilst moving as it could bend the product frame.
- Users should be familiar with the assembly manual. This manual contains assembly guidance; selected precautionary measures as well as recommendations for servicing and maintenance of the product, in order to ensure a secured and fun use of the product.
- It is the responsibility of the owner or the supervisor to guarantee that all users of the product are informed sufficiently of all warning references and safety instructions.

For the supervisor

The supervisor's role is to make sure users are aware of all safety precautions and that these precautions are enforced. When a supervisor is not available, the product may be disassembled or covered to limit access.

- The product can be only used if it is in good condition, worn or damaged parts should be replaced.
- Objects, which could be dangerous to the user, should be away from the product.
- Avoid unauthorized and unsupervised use of the product.
- Do not use the product under influence of alcohol or drugs (incl. medicines).
- Do not use the product as a jumping platform for other articles.

Consumer Information Sheet for Playground Surfacing Materials

The US Consumer Product Safety Commission (CPSC) estimates that about 100 000 playground equipment-related injuries resulting from falls to the ground surface are treated annually in US hospital emergency rooms. Injuries involving this hazard pattern tend to be among the most serious of all playground injuries, and have the potential to be fatal, particularly when the injury is to the head. The surface under and around playground equipment can be a major factor in determining the injury-causing potential of a fall. It is self-evident that a fall on to a shock-absorbing surface is less likely to cause a serious injury than a fall onto a hard surface. Playground equipment should never be placed on hard surfaces, such as concrete or asphalt, and while grass may appear to be acceptable, it may quickly turn to hard-packed earth in areas of high traffic. Shredded bark mulch, wood chips, tine sand or the gravel are considered to be acceptable shock absorbing surfaces when installed and maintained at a sufficient depth under and around playground equipment.

Table B.1 Lists the maximum height from which a child would not be expected to sustain a life-threatening head injury in a fall on to four different loose-fill surfacing materials if they are Installed and maintained at depths of 150 mm, 225 mm and 300 mm.

Table B.1 Fall height in millimetres from which a life-threatening head injury would not be expected.







Type of Material	Depth of surfacing material		
	150mm	225mm	300mm
Double Shredded Bark Mulch	1800	3000	3300
Wood Chips	1800	2100	3600
Fine Sand	1500	1500	2700
Fine Gravel	1800	2100	3000



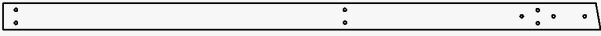
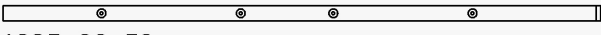
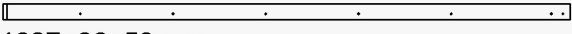
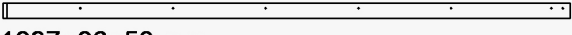
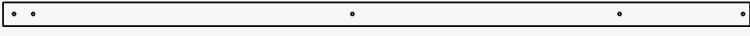
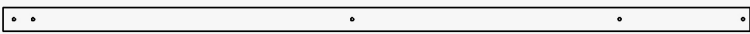
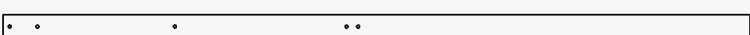
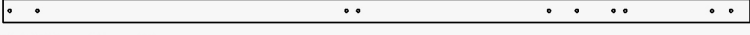
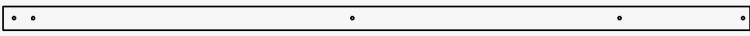
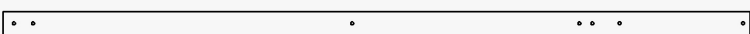
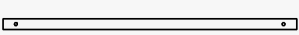
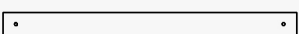
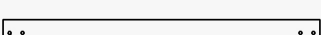
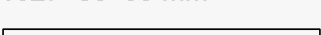
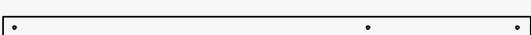
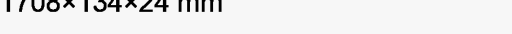

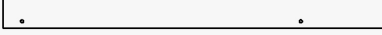
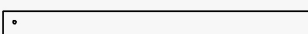

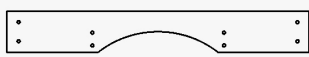

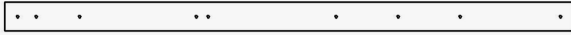

However, it should be recognised that all injuries due to falls cannot be prevented, no matter what surfacing material is used.

It is recommended that a shock absorbing material extend a minimum of 1 800 mm in all directions from the perimeter of stationary equipment such as climbing frames and slides. However, because children may deliberately jump from a moving swing, the shock absorbing material should extend in the front and rear of a swing a minimum distance of twice the height of the pivot point measured from a point directly beneath the pivot on the supporting structure.

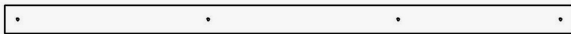
This information is intended to assist in comparing the relative shock-absorbing properties of various materials. No particular material is recommended over another. However, each material is only effective when properly maintained. Materials should be checked periodically and replenished to maintain correct depth as determined necessary for the equipment in question. The choice of a material depends on the type and height of the playground equipment, the availability of the material in a particular area, and its cost.

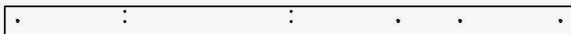
III. ASSEMBLY INSTRUCTIONS

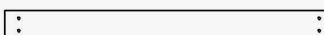
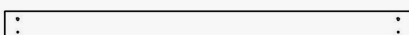
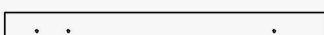
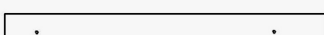
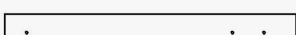
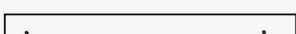
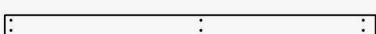
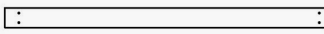
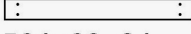
- B1A=1**  1935×86×50 mm
- B1B=1**  1935×86×50 mm
- B2A=1**  1837×86×50 mm
- B2B=1**  1837×86×50 mm
- C1=1**  2420×76×76 mm
- C2=1**  2420×76×76 mm
- C3=1**  2420×76×76 mm
- C4=1**  2420×76×76 mm
- C5=1**  2420×76×76 mm
- C6=1**  2420×76×76 mm
- C7=2**  951×76×35 mm
- C8=2**  951×76×35 mm
- C9=2**  1027×86×35 mm
- C10=2**  1027×86×35 mm
- D1=1**  1708×134×24 mm
- D2=1**  1641×134×24 mm
- D3=1**  1665×134×24 mm
- D4=1**  1220×134×24 mm
- D5=1**  979×134×24 mm
- D6=3**  266×134×24 mm
- D7=1**  464×134×24 mm
- D9=1**  979×134×24 mm
- D68=2**  268×134×24 mm

- F1=1 
1708×86×24 mm
- F2=1 
1665×86×24 mm
- F3=1 
1220×86×24 mm
- F4=1 
738×86×24 mm
- F5=1 
1708×86×24 mm
- F6=1 
962×86×24 mm
- F7=1 
1708×86×24 mm
- F8=1 
714×86×24 mm
- F9=1 
1220×86×24 mm
- F10=1 
564×86×24 mm
- F11=1 
962×86×24 mm
- F13=2 
1220×86×24 mm
- F14A=2 
961×86×24 mm
- F14B=1 
961×86×24 mm
- F15A=2 
875×86×24 mm
- F15B=1 
875×86×24 mm
- F16=1 
1115×60×24 mm
- F17=1 
962×60×24 mm
- F18=1 
564×60×24 mm
- F19=1 
1617×60×24 mm

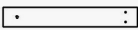
F20=2 
420×60×24 mm

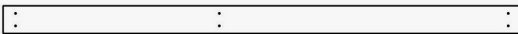
F21=1 
1617×86×24 mm

F22=1 
979×86×24 mm

F23=4 
476×86×24 mm

F24=2 
234×86×24 mm

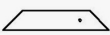
F25=2 
330×60×24 mm

F26=2 
1027×86×24 mm

F27=2 
172×86×24 mm

F28=2 
998×86×24 mm

F29=1 
1558×86×24 mm

F31=1 
1900×86×24 mm

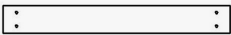
F32=2 
710×86×24 mm

F33=2 
630×86×24 mm

F34=2 
1150×86×24 mm

F35=1 
630×60×24 mm

F36=2 
300×86×24 mm

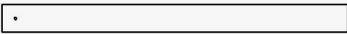
F39=2 
1082×86×24 mm

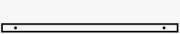
F40=2 
550×24×24 mm

FP1=1

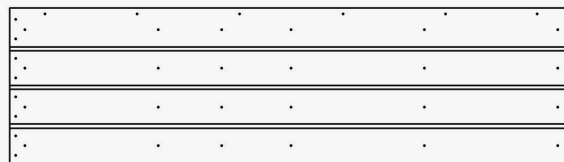

FP2=1

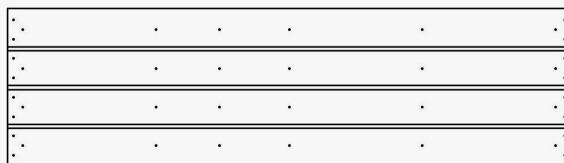

FP3=1



FP4=1

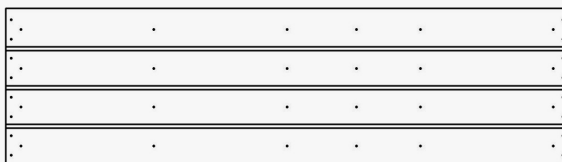

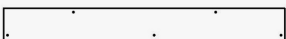

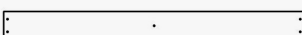
H1=1  868×100×16 mm

H2=11  927×86×16 mm

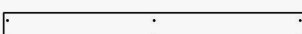
H3=1  827×76×16 mm

H4=2  927×100×16 mm

H5=2  927×86×16 mm

H6=1  827×100×16 mm

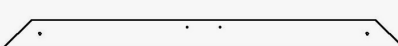
H7=2  1233×86×16 mm

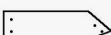
H8=4  332×86×16 mm

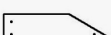
H9=4  337×86×16 mm

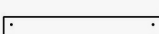
H10=2  484×86×16 mm

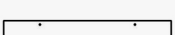
H11=2  516×100×16 mm

H12=5  1268×86×16 mm

H13=1  1268×132×16 mm

H14=18  846×86×16 mm

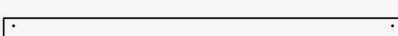
H15A=2  1230×86×16 mm

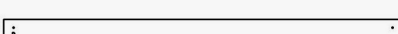
H15B=2  1230×86×16 mm

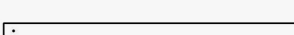
H16=4  906×86×16 mm

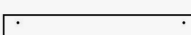
H18=2  599×134×16 mm

H19=3  979×86×16 mm

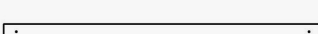
H20=1  979×86×16 mm

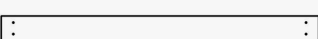
H21=2  979×76×16 mm

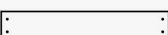
H23=1  516×86×16 mm

H24=8  600×86×16 mm

H25=1  600×134×16 mm

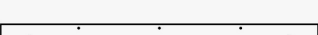
H26=1  979×86×16 mm

H27=2  979×86×16 mm

H28=1  172×60×16 mm

H29=1  234×60×16 mm

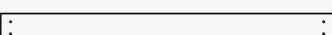
H30=6  1026×86×16 mm

H31=14  636×86×16 mm

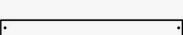
H32=6  560×86×16 mm

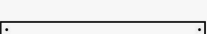
H33=2  630×86×16 mm

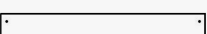
H35=2  630×132×16 mm

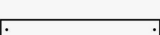
H38=1  490×60×16 mm

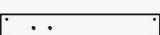
H39=7  490×86×16 mm

H40=7  490×86×16 mm

H42=2  342×35×16 mm

FA26=9 

86×76×24 mm

T1=2 

89×60×24 mm

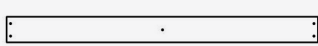
H43=2 

927×76×16 mm

H44=1 

1068×76×16 mm

H49=1 

1759×50×16 mm

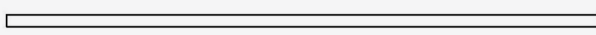
H50=1 

1759×35×16 mm

H54=4 

110×86×16 mm

K1=2 

714×60×35 mm

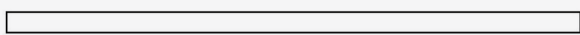
K2=1 

1708×60×35 mm

K3=2 

1585×86×35 mm

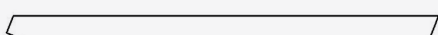
K5=2 

1286×86×35 mm

K8=2 

1888×86×35 mm

K9=2 

1935×86×35 mm

K22=1 

1284×86×35 mm

K23=1 

1284×86×35 mm

K30=10 

300×60×35 mm

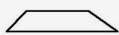
K33=2 

330×60×35 mm

WP1=3

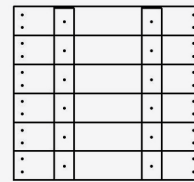



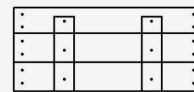



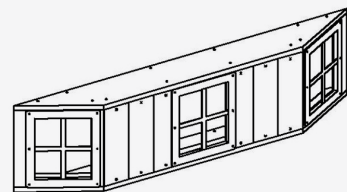











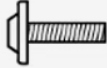









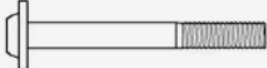

WP2=1



SILL=1



PARTS LIST

BM615 	N815 	BM818 	AN8 
B-NUT x22	NUT x169	NUT x30	A-NUT8 X4
W12/28 	W8/15 	W10/18 	N610 
Washer X4	Washer X20	Washer X147	B-NUT x2
M625 		S315 	
Bolt x20		Screw x12	
M633 		S321 	
Bolt x 2		Screw x8	
M821 		S328 	
Bolt x24		Screw x9	
M833 		SW28 	
Bolt x14		Screw x17	
M845 		SW35 	
Bolt x32		Screw x683	
M855 		SW40 	
Bolt x32		Screw x34	
M865 		SW50 	
Bolt x2		Screw x88	
M880 		SW60 	
Bolt x8		Screw x12	
M896 		M6SW35 	
Bolt x69		Screw x64	
M8107 		M6SW55 	
Bolt x10		Screw x22	
M8125 		M615 	
Bolt x4		Bolt x2	

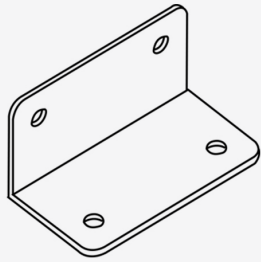

(1) L651003

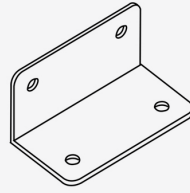

(6) L651015

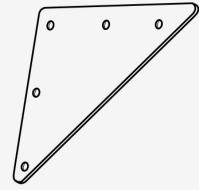

(4) L651007



(13) L651006

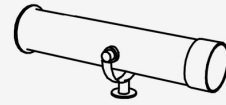

(1) L650008



(2) L651025

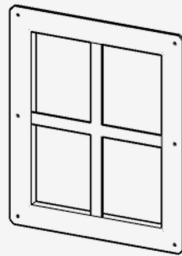

(2) 650051



(9) 139070



(10) 152004

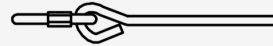

(4) 650019



(10) 152003

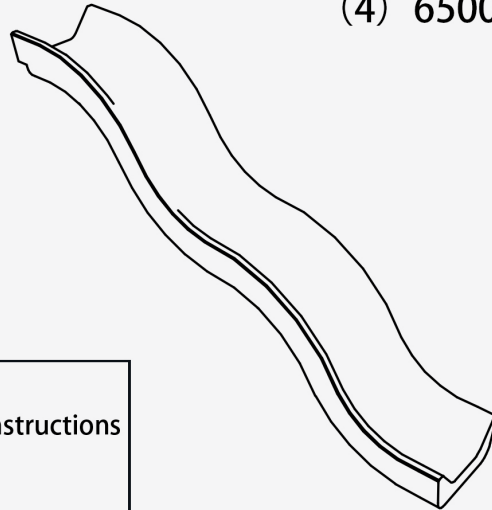

(1) L650001

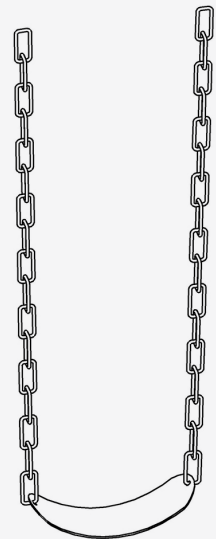

(2) 108001

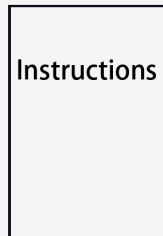

(1) 152090

3.1 SET UP

STEP 1

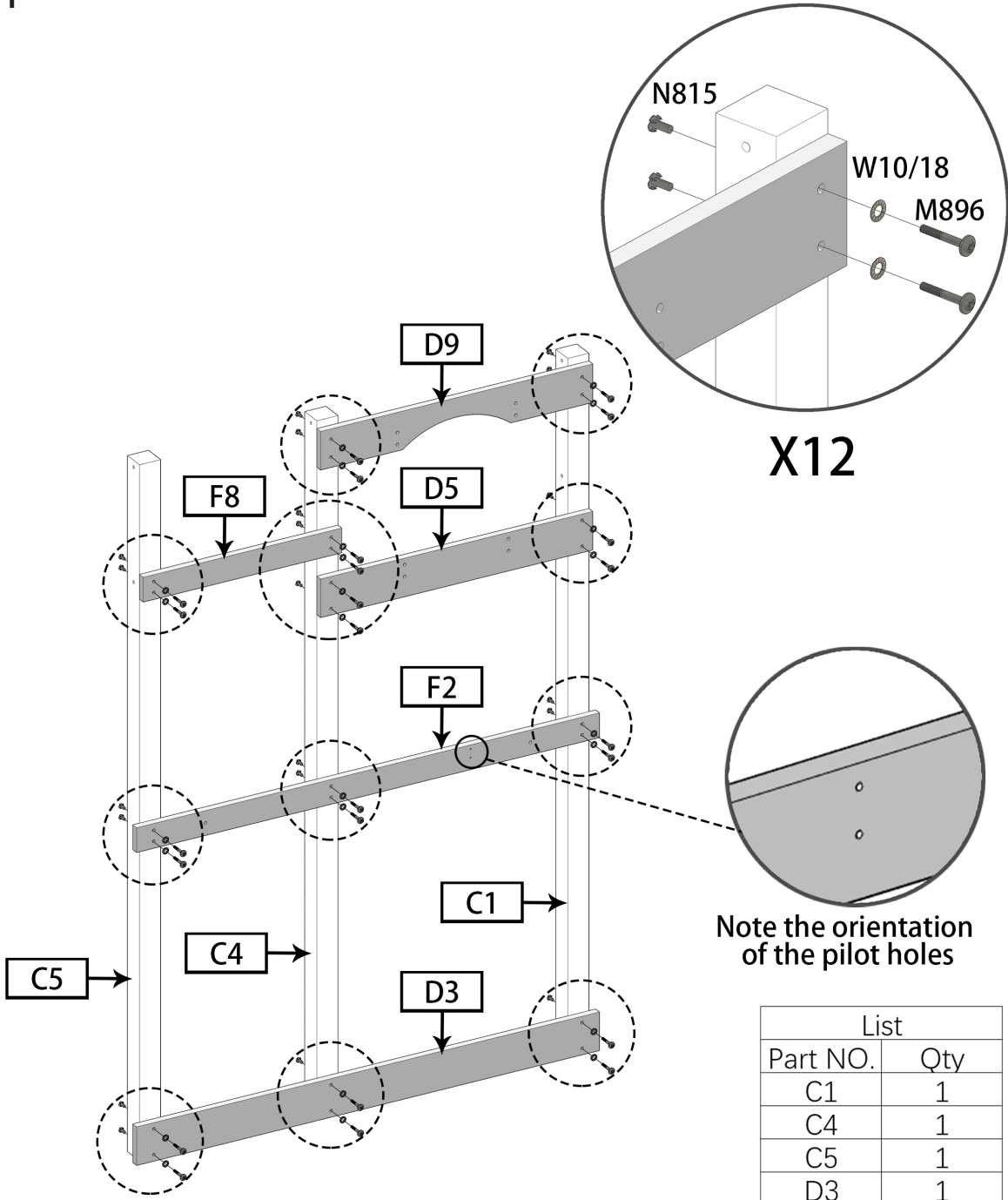

Note the orientation of the pilot holes

List	
Part NO.	Qty
C1	1
C4	1
C5	1
D3	1
D5	1
D9	1
F2	1
F8	1
M896	24
W10/18	24
N815	24

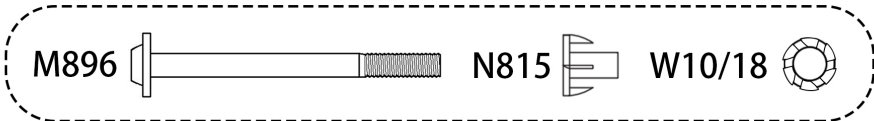

STEP 2

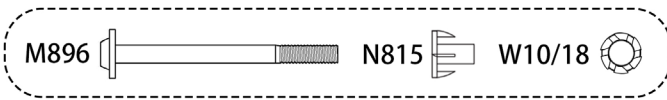
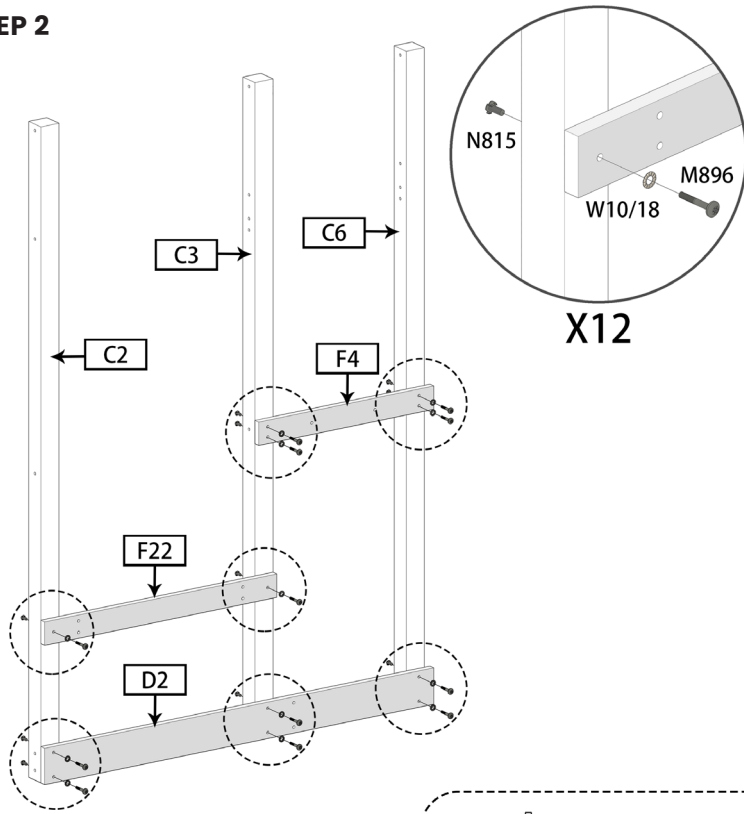

List	
Part NO.	Qty
C2	1
C3	1
C6	1
D2	1
F4	1
F22	1
M896	12
W10/18	12
N815	12

STEP 3

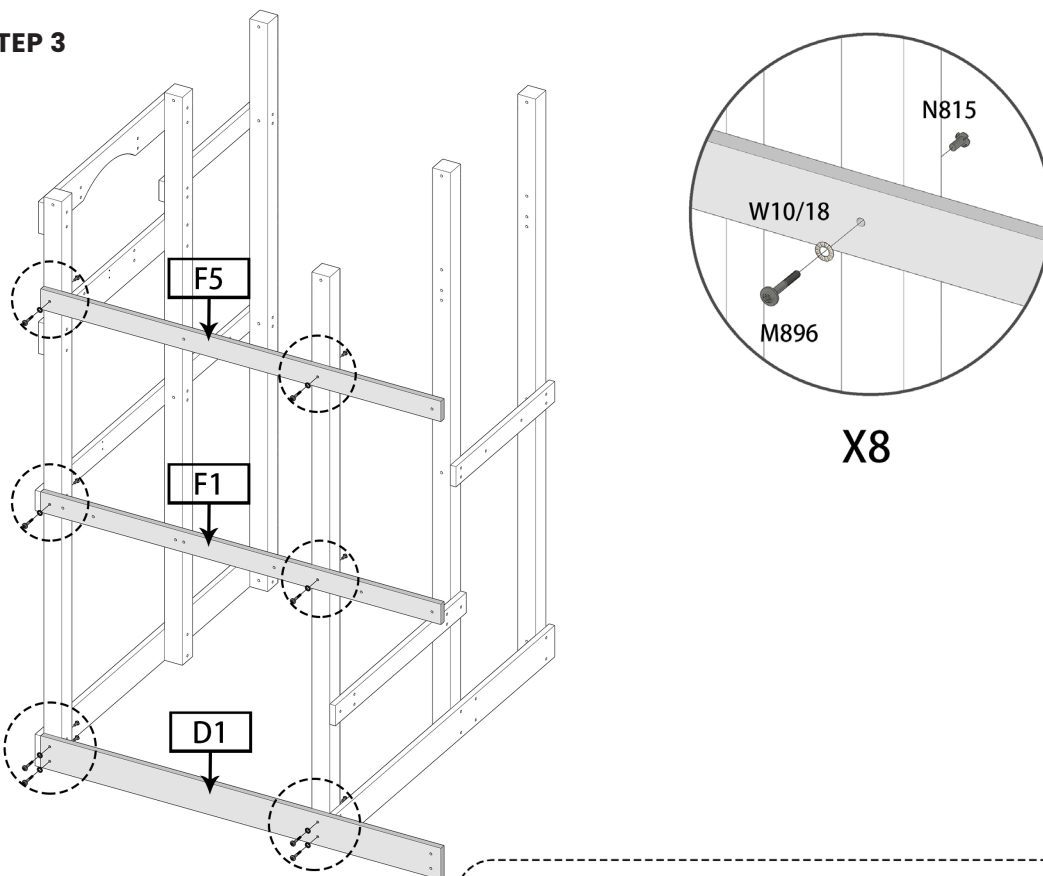

List	
Part NO.	Qty
F1	1
F5	1
D1	1
M896	8
W10/18	8
N815	8

STEP 4

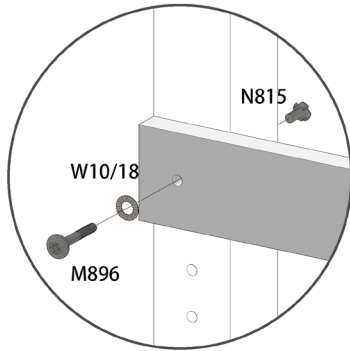

X8

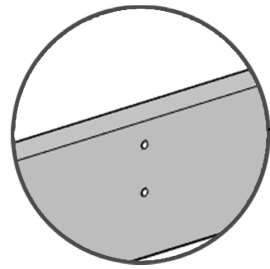

Note the orientation of the pilot holes

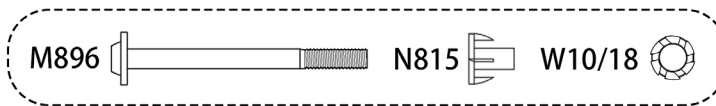
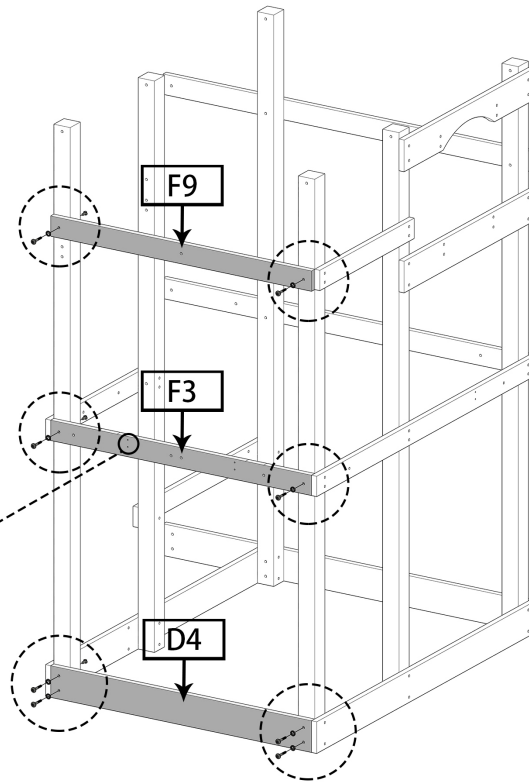

List	
Part NO.	Qty
F3	1
F9	1
D4	1
M896	8
W10/18	8
N815	8

STEP 5

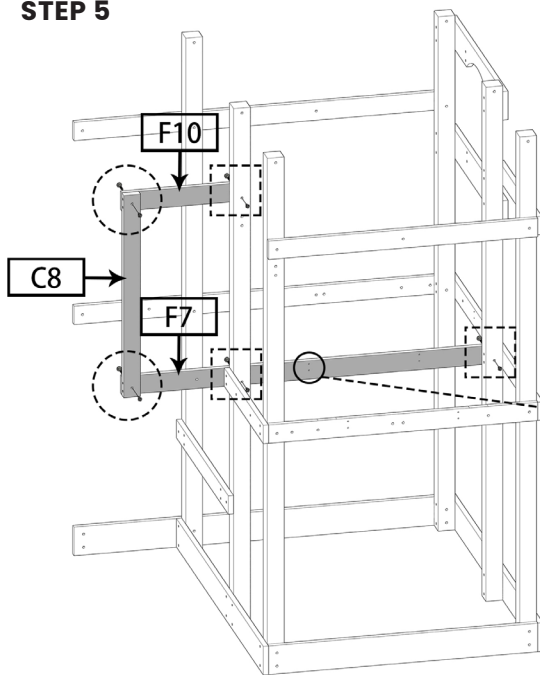

Note the orientation of the pilot holes

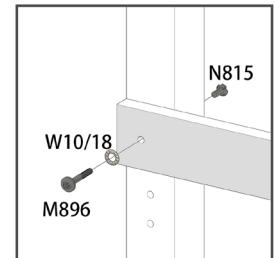

X3

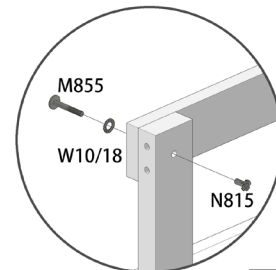

X2

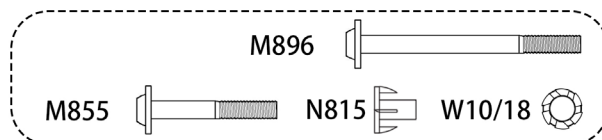

List	
Part NO.	Qty
F7	1
F10	1
C8	1
M855	2
M896	3
W10/18	5
N815	5

STEP 6

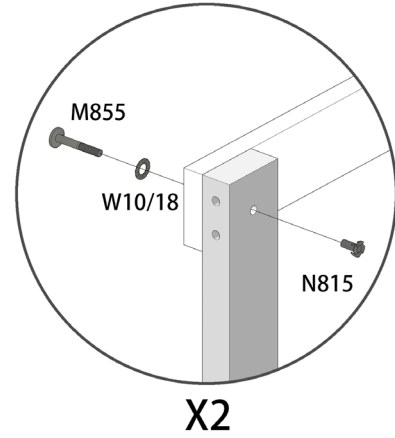
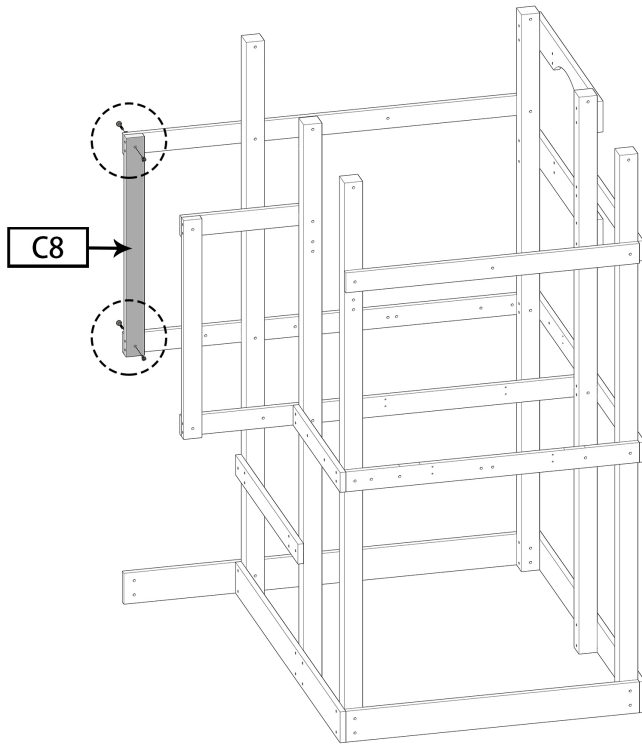

X2

List	
Part NO.	Qty
C8	1
M855	2
W10/18	2
N815	2



STEP 7

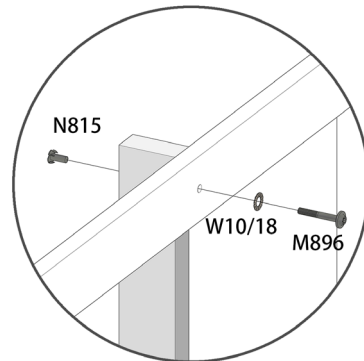
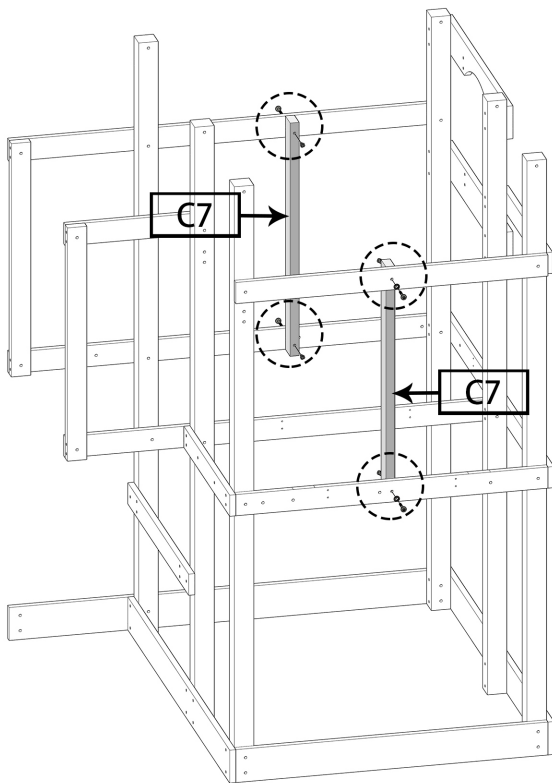

X4

List	
Part NO.	Qty
C7	2
M896	4
W10/18	4
N815	4

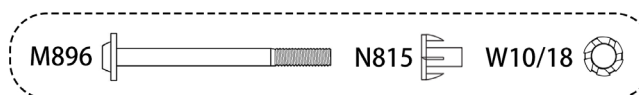

STEP 8

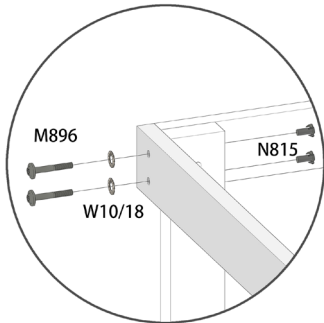

X4

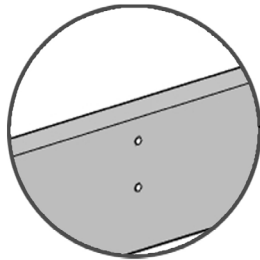

Note the orientation of the pilot holes

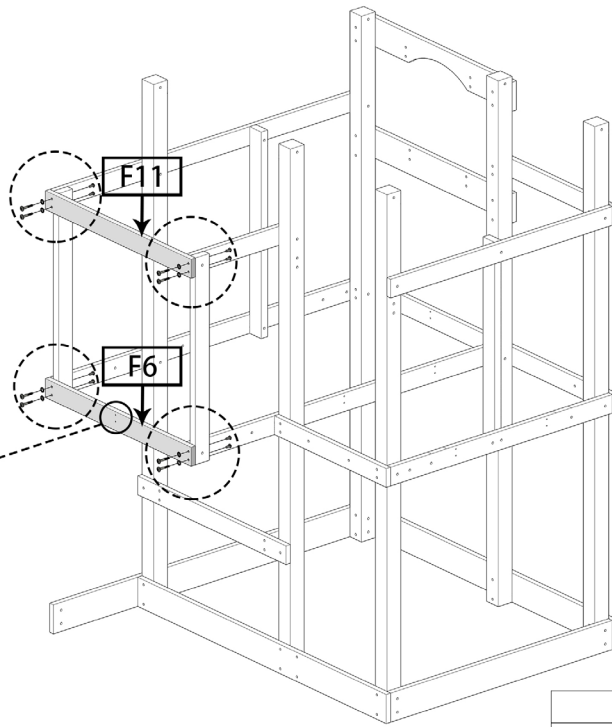

List	
Part NO.	Qty
F6	1
F11	1
M896	8
W10/18	8
N815	8

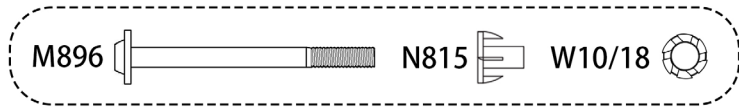

STEP 9

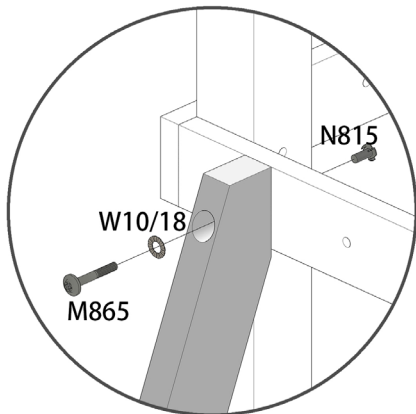

X2

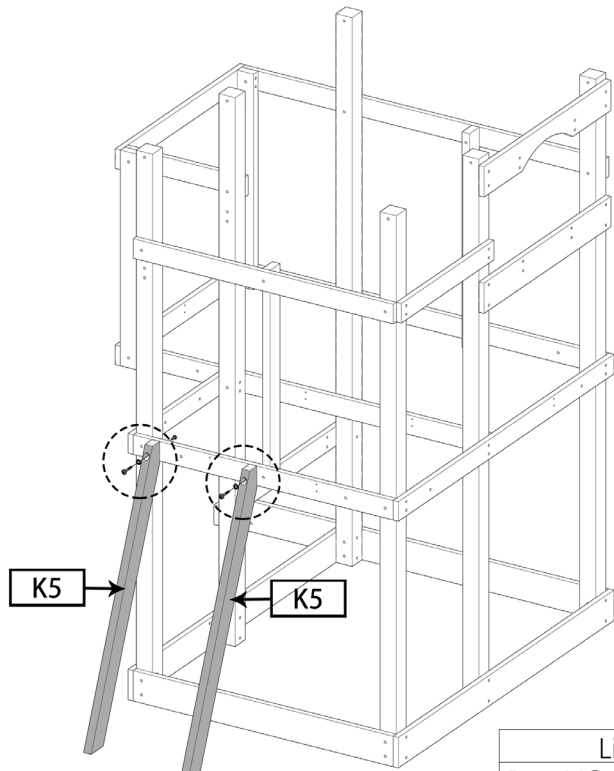

List	
Part NO.	Qty
K5	2
M865	2
W10/18	2
N815	2



STEP 10

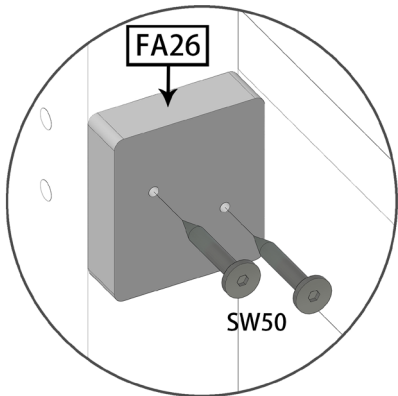

X9

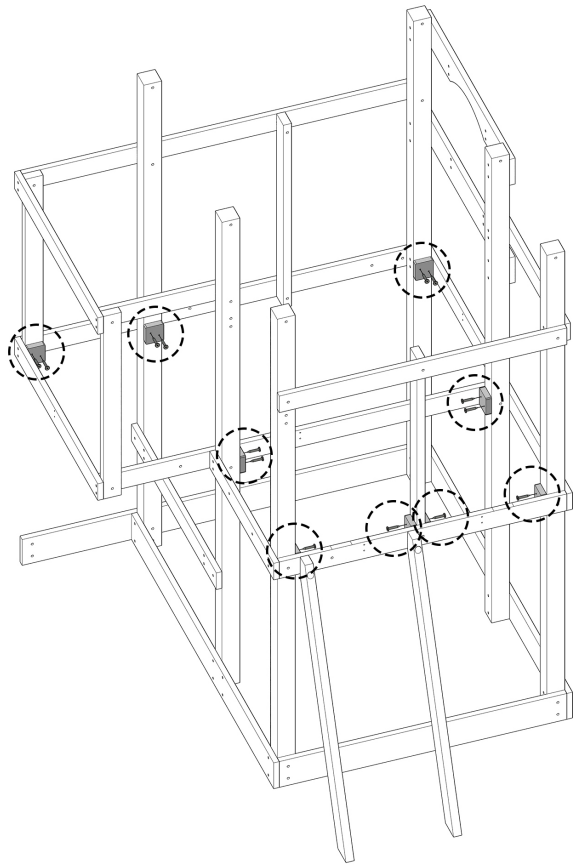

List	
Part NO.	Qty
FA26	9
SW50	18

STEP 11

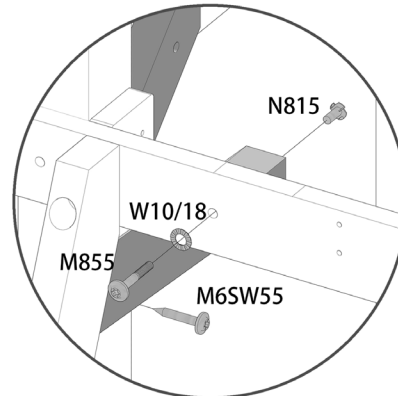
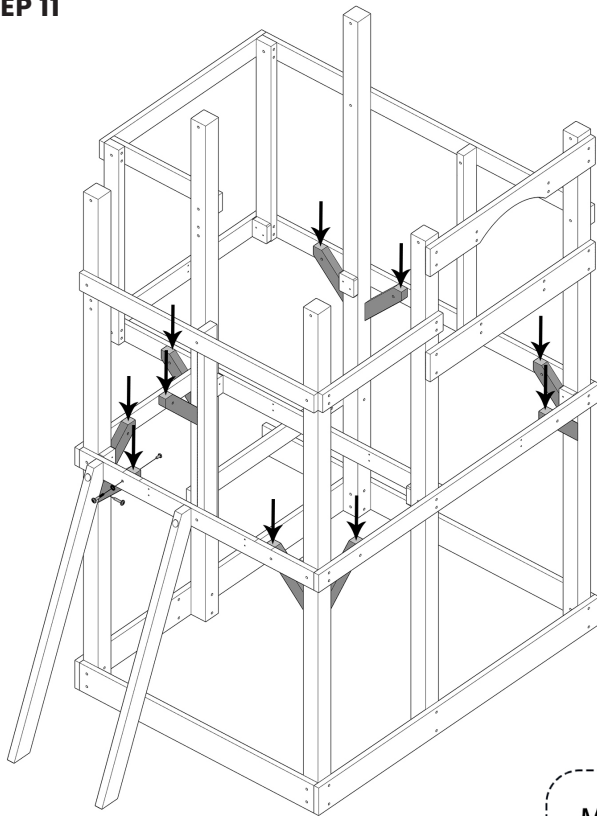

K30 X10

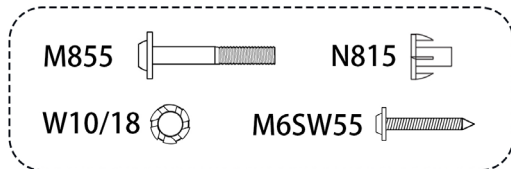

List	
Part NO.	Qty
K30	10
M855	10
W10/18	10
N815	10
M6SW55	10

STEP 12

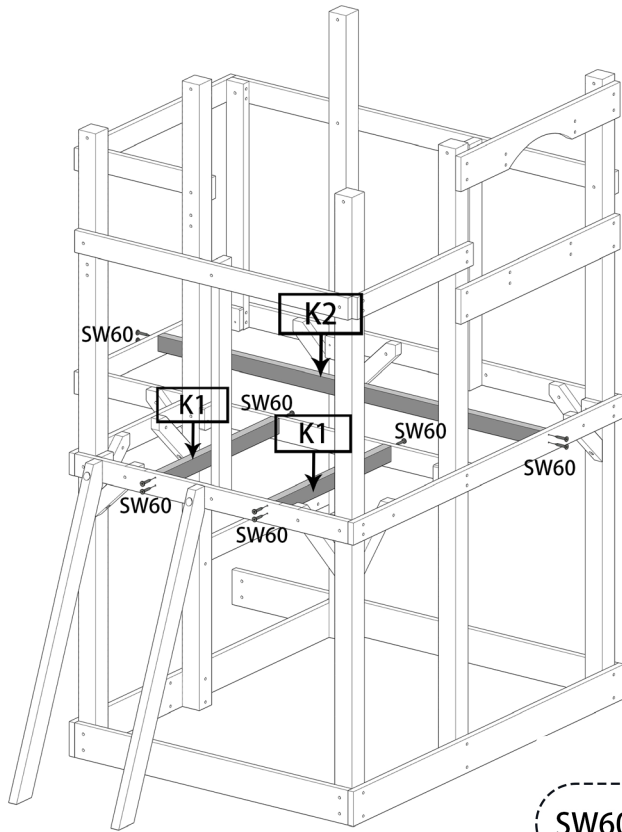

List	
Part NO.	Qty
K1	2
K2	1
SW60	12

STEP 13

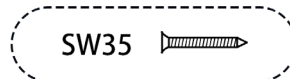
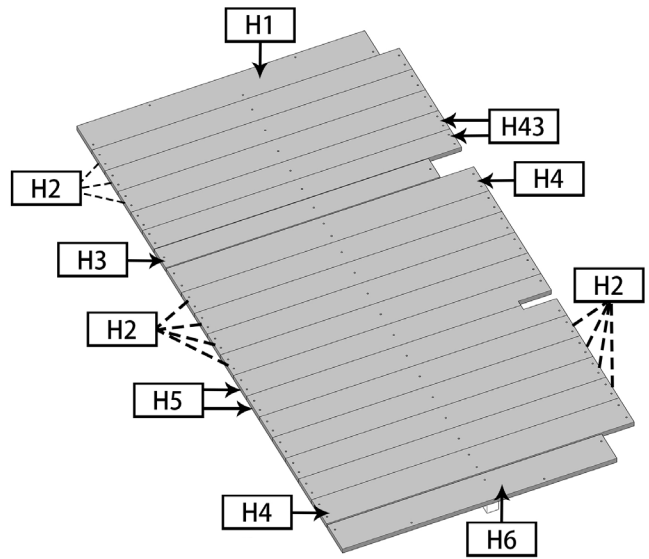
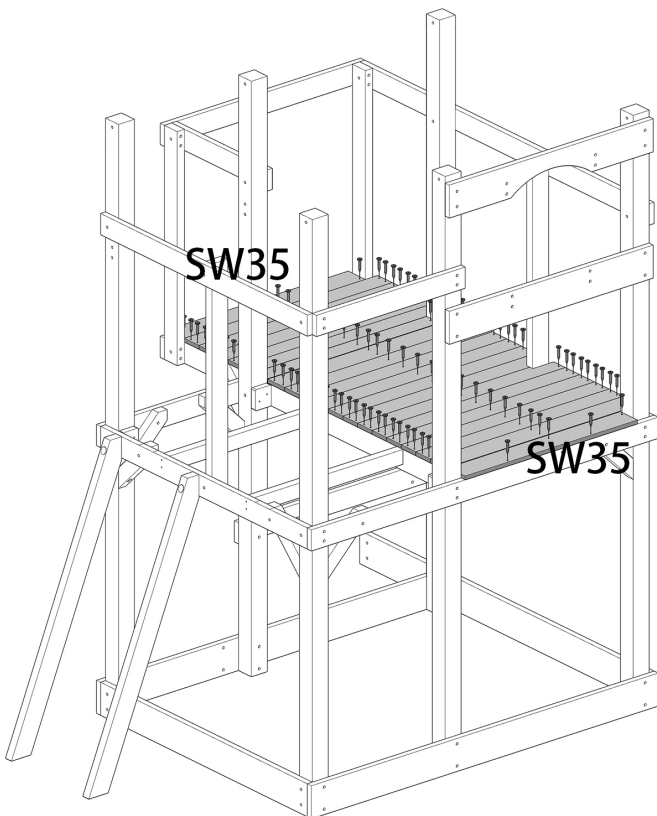

List	
Part NO.	Qty
H1	1
H2	11
H3	1
H4	2
H5	2
H6	1
H43	2
SW35	98

STEP 14

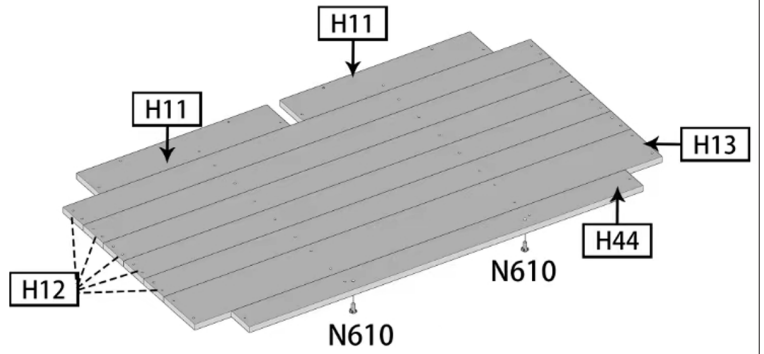
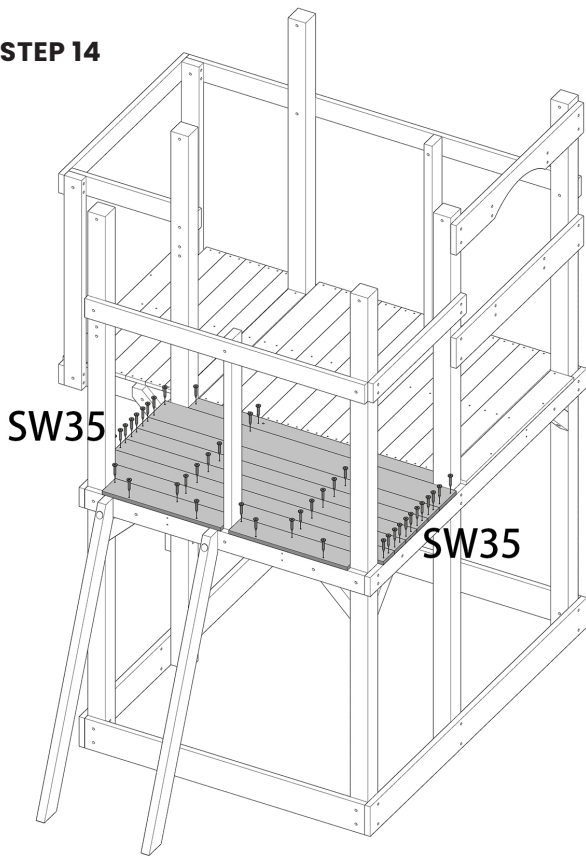

The hole of $\varnothing 8$ at the bottom of H44 is knocked into the claw mother first



List	
Part NO.	Qty
H11	2
H12	5
H13	1
H44	1
SW35	52
N610	2

STEP 15

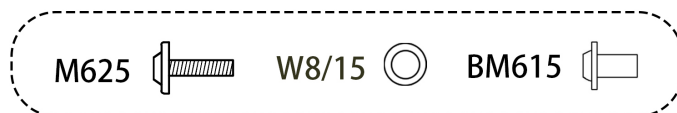
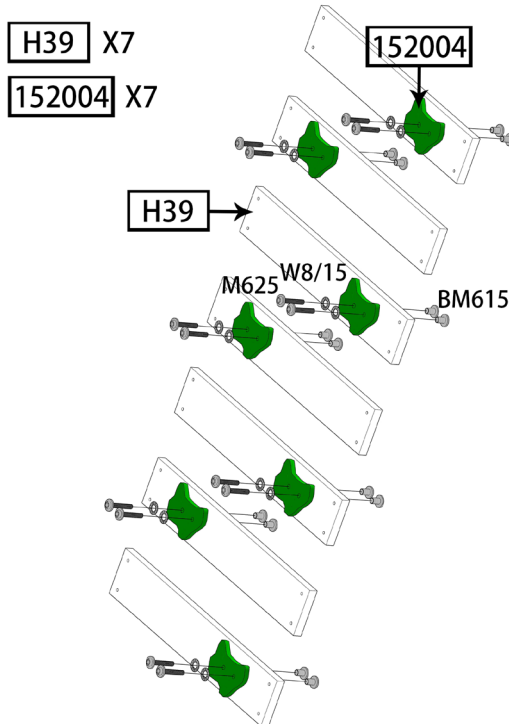

List	
Part NO.	Qty
H39	7
M625	14
W8/15	14
BM615	14
152004	7

STEP 16

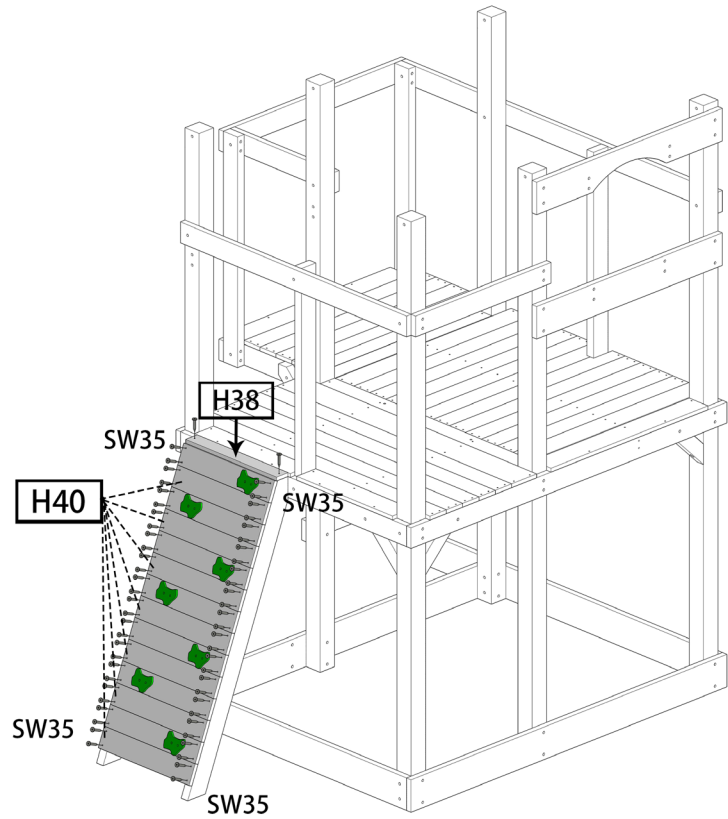

List	
Part NO.	Qty
H38	1
H40	7
SW35	58

STEP 17

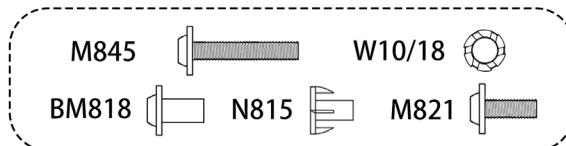
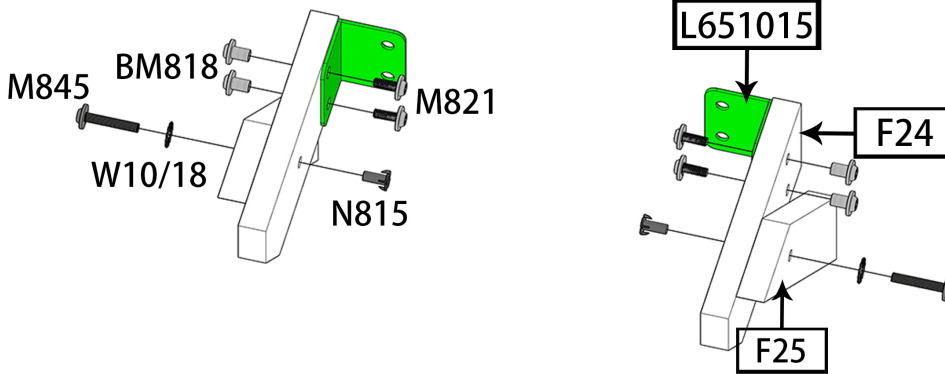

List	
Part NO.	Qty
F24	2
F25	2
M845	2
W10/18	2
N815	2
M821	4
BM818	4
L651015	2

STEP 18

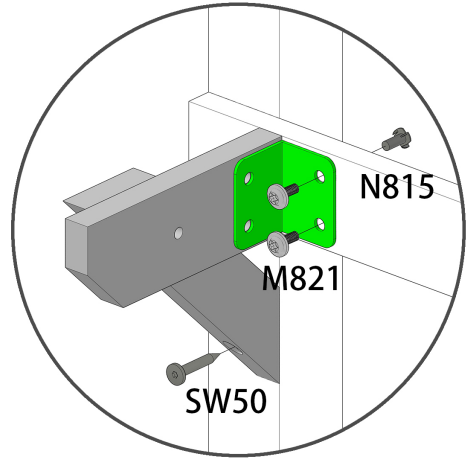
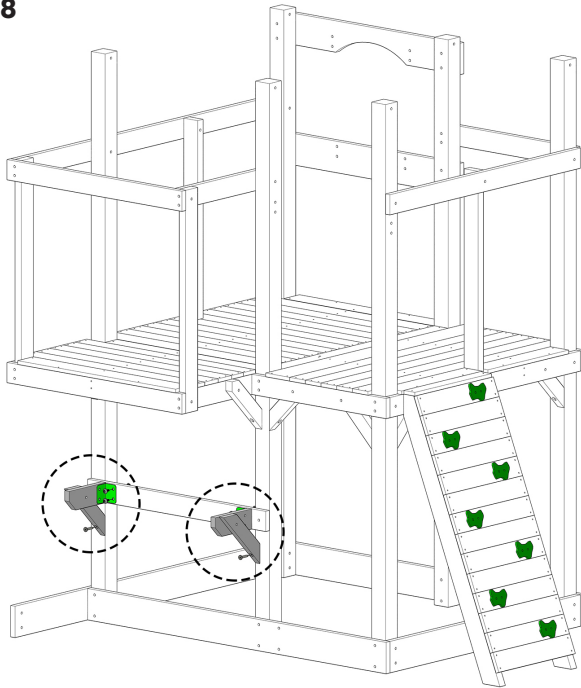

X2

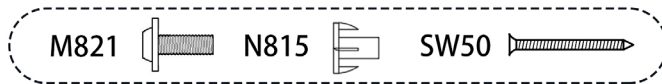

List	
Part NO.	Qty
M821	4
N815	4
SW50	2

STEP 19

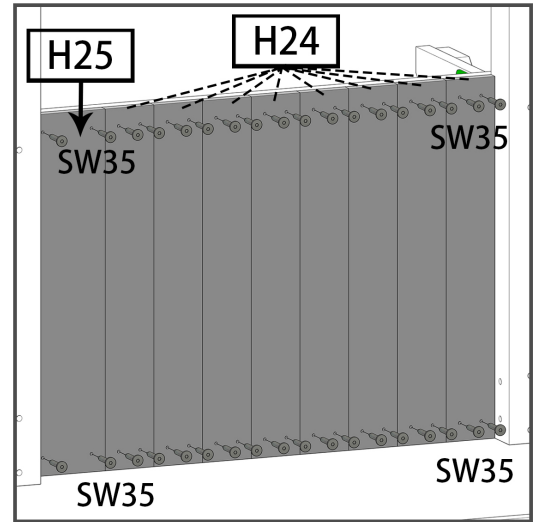
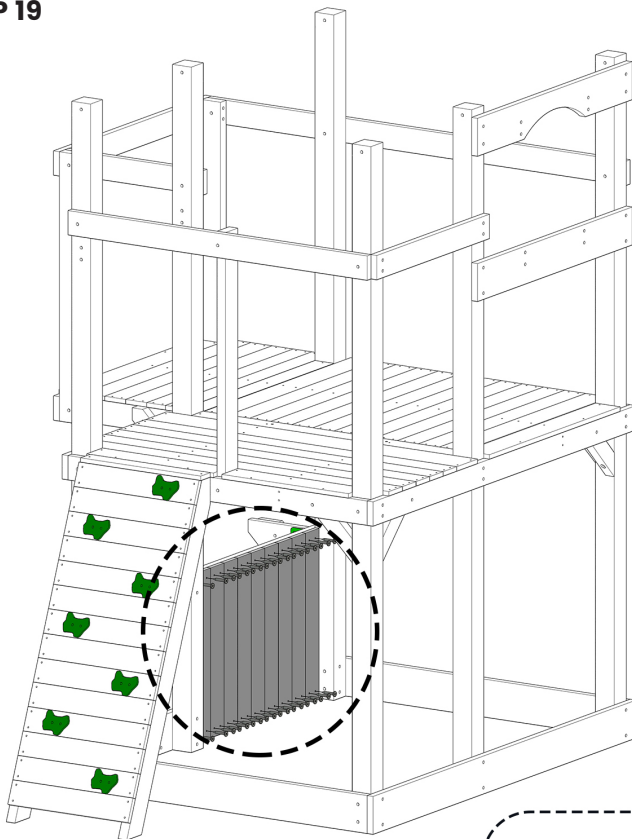

List	
Part NO.	Qty
H24	8
H25	1
SW35	36

STEP 20

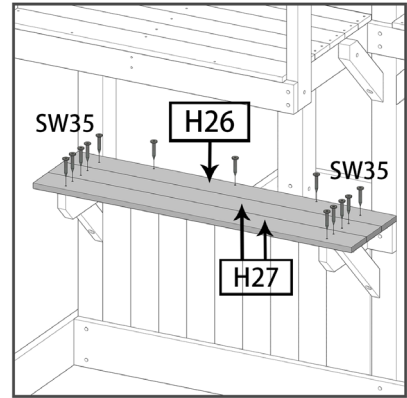
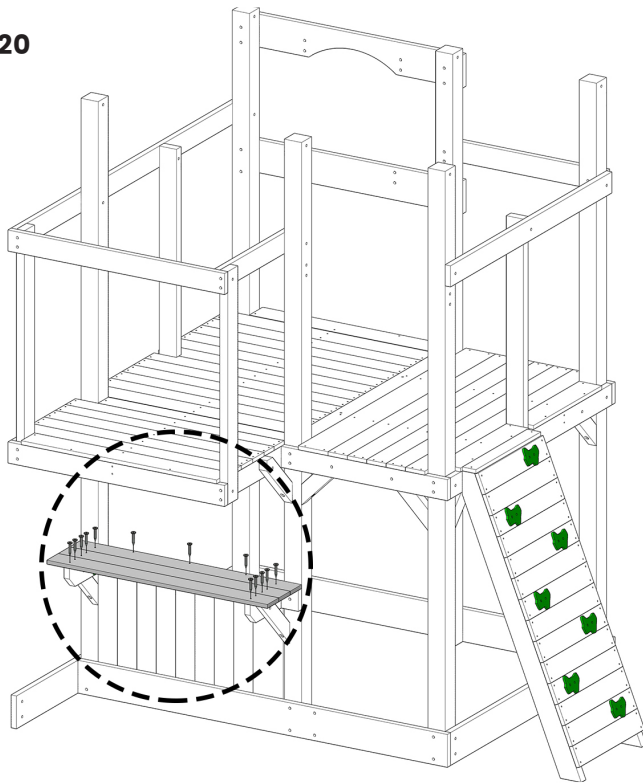

List	
Part NO.	Qty
H26	1
H27	2
SW35	13

STEP 21

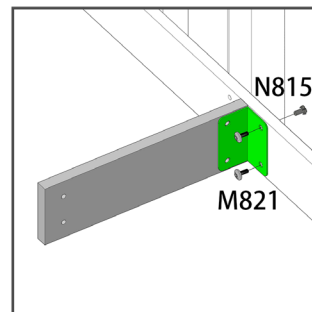
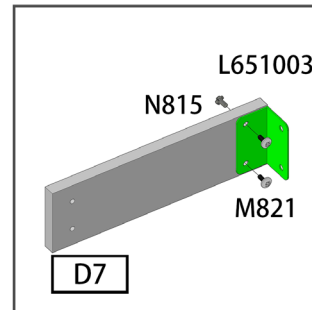
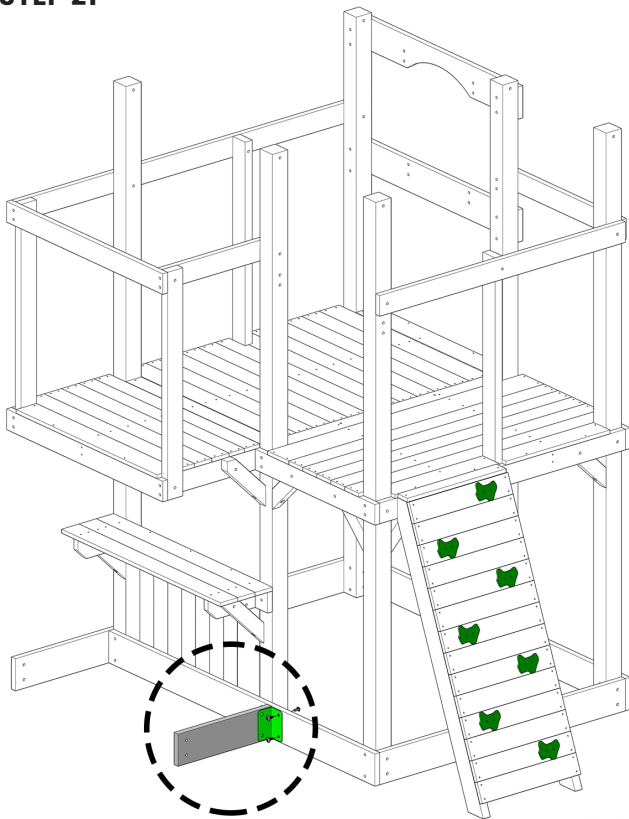

List	
Part NO.	Qty
D7	1
N815	4
M821	4
L651003	1

STEP 22

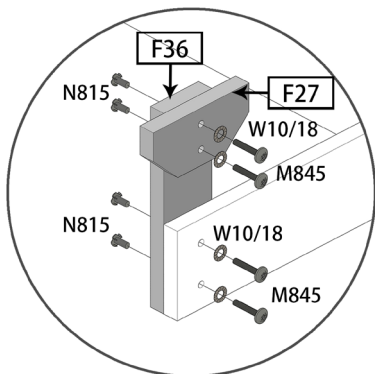

X2

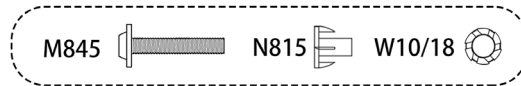
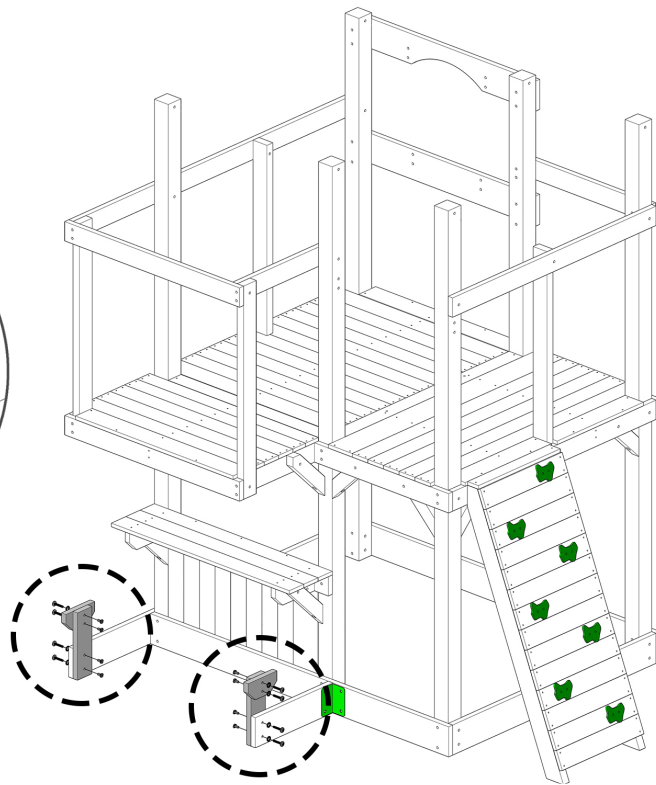

List	
Part NO.	Qty
F27	2
F36	2
M845	8
W10/18	8
N815	8

STEP 23

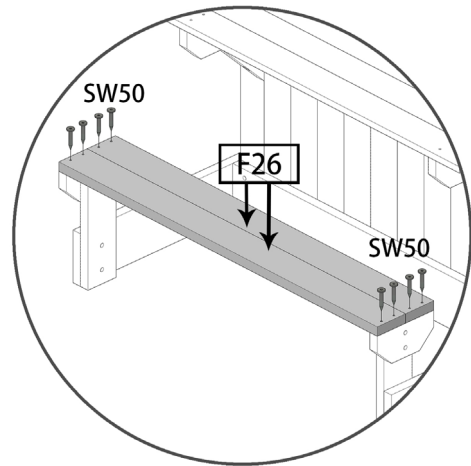
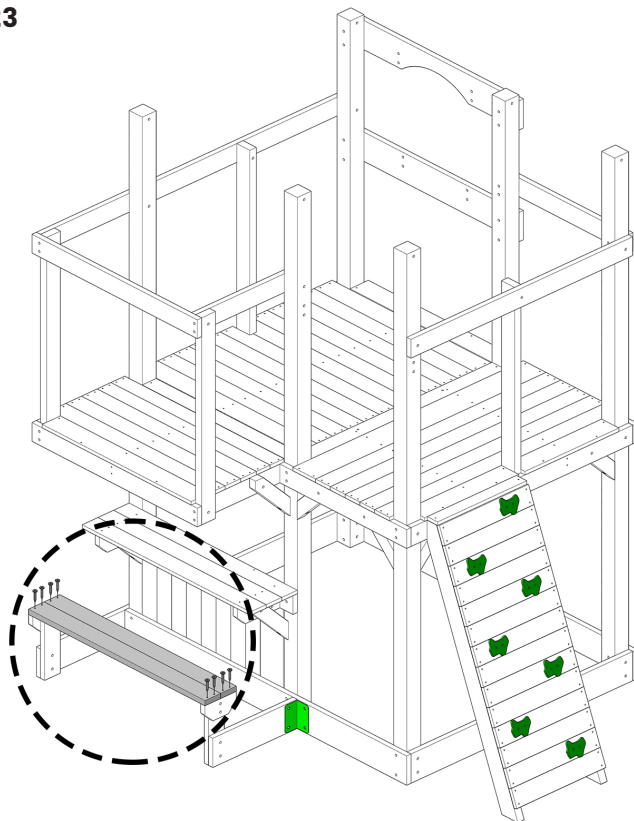

List	
Part NO.	Qty
F26	2
SW50	8

STEP 24

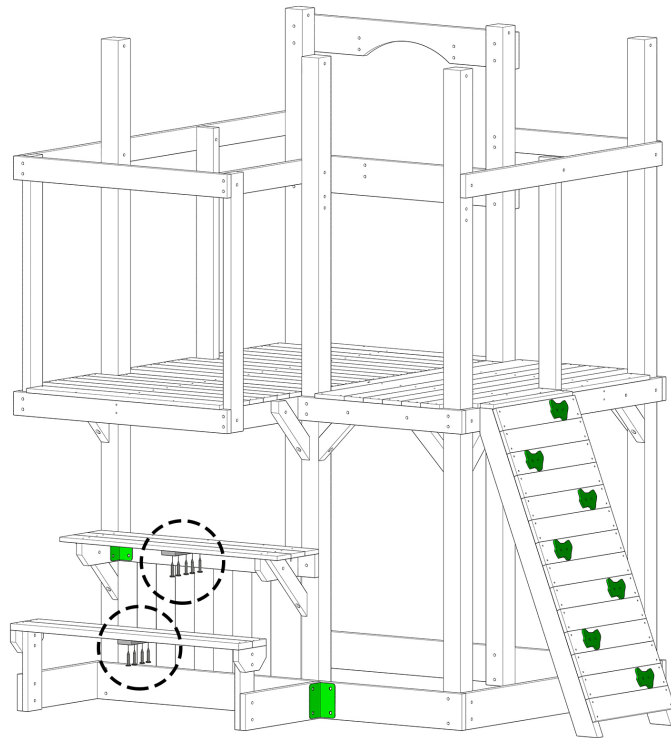
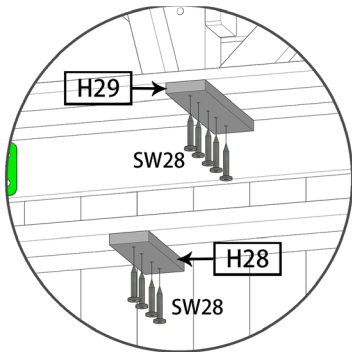

List	
Part NO.	Qty
H28	1
H29	1
SW28	9

STEP 25

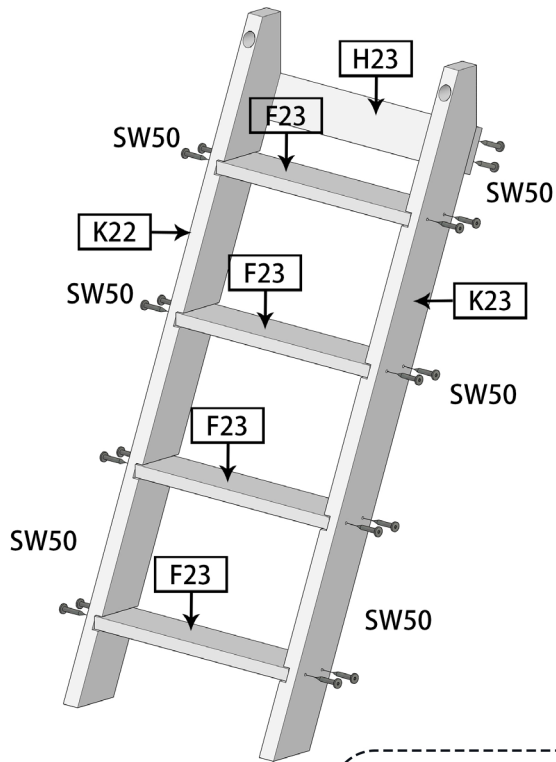

List	
Part NO.	Qty
H23	1
F23	4
K22	1
K23	1
SW50	20

STEP 26

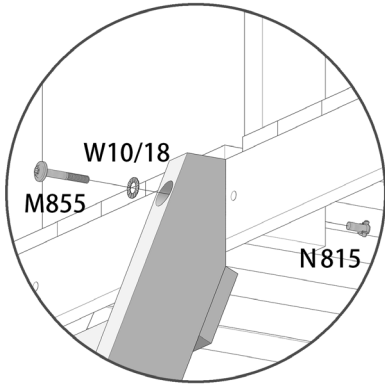

X2

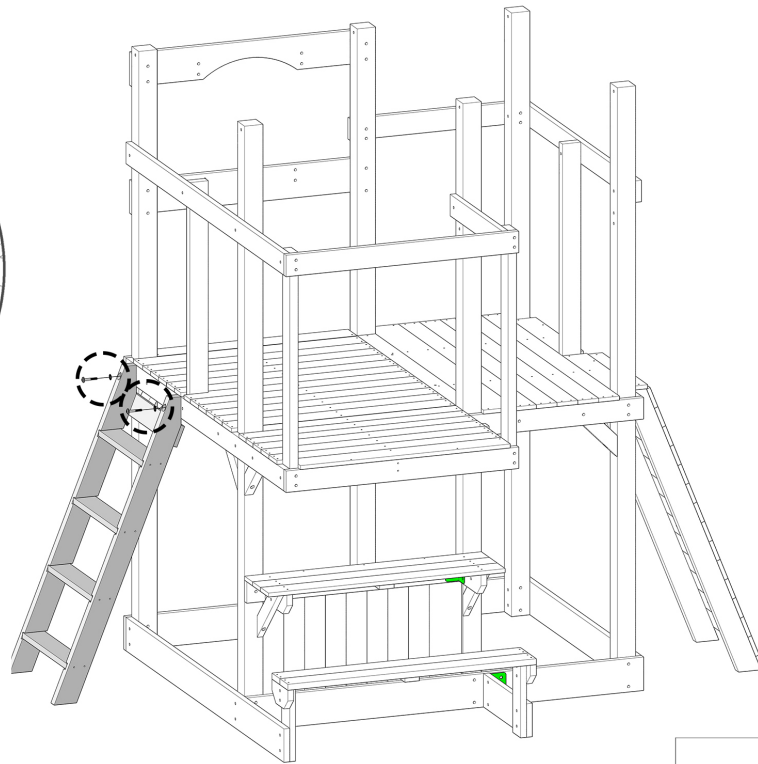

List	
Part NO.	Qty
M855	2
W10/18	2
N815	2

STEP 27

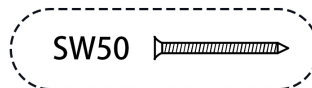
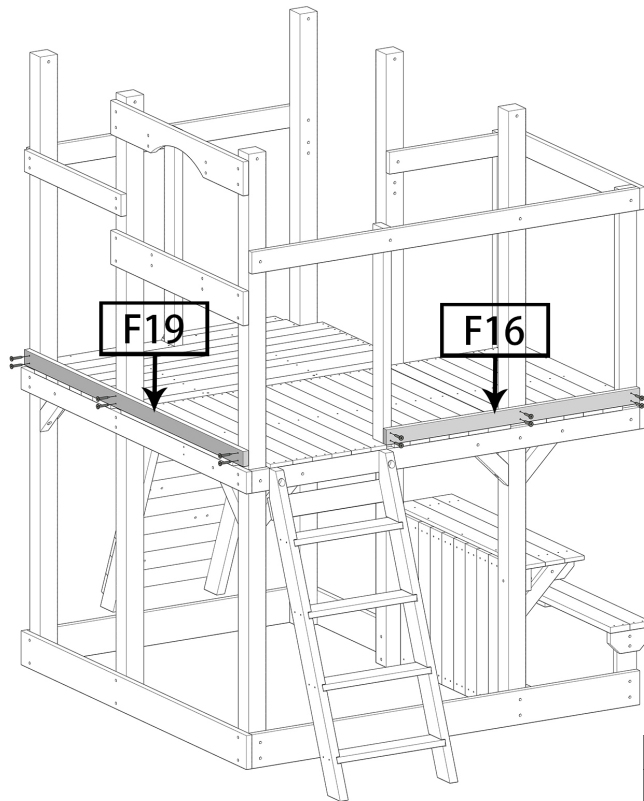
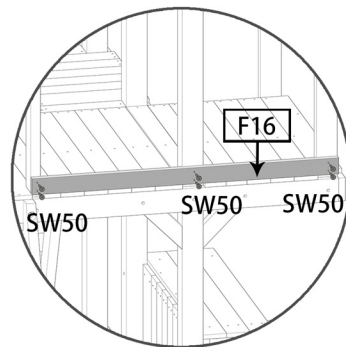
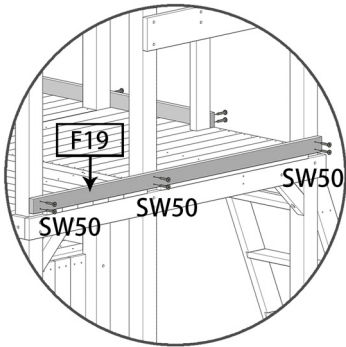

List	
Part NO.	Qty
F16	1
F19	1
SW50	12

STEP 28

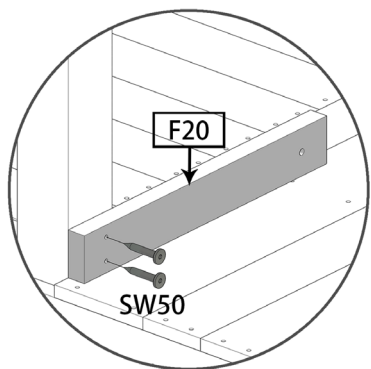
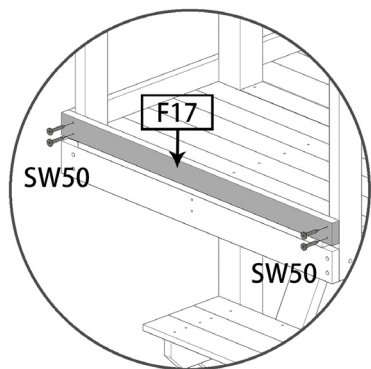

X2

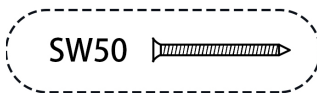
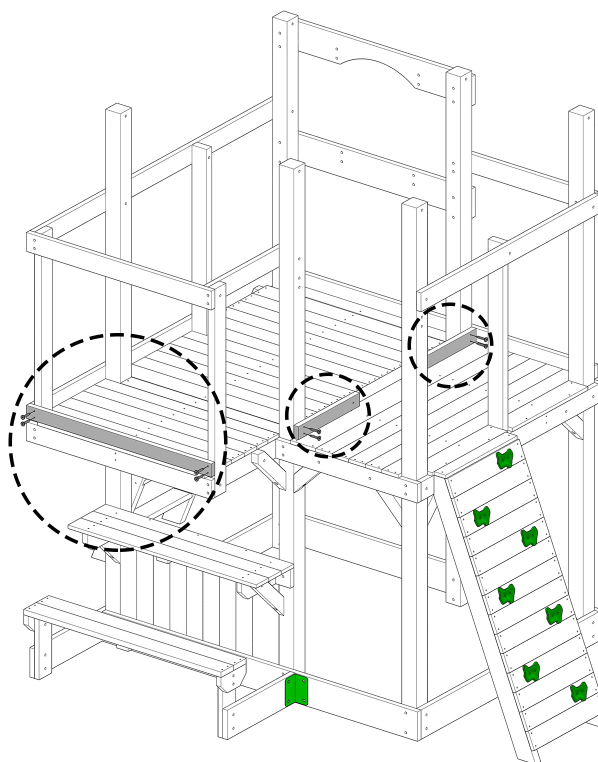

List	
Part NO.	Qty
F17	1
F20	2
SW50	8

STEP 29

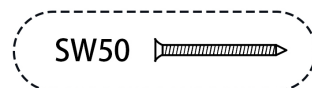
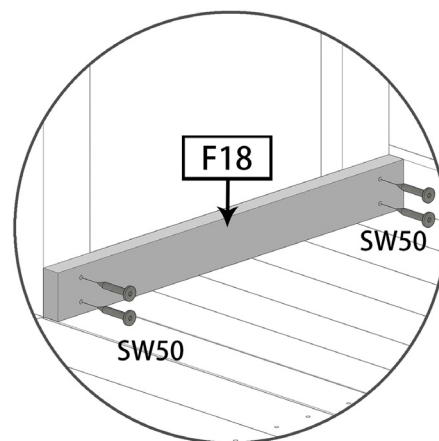
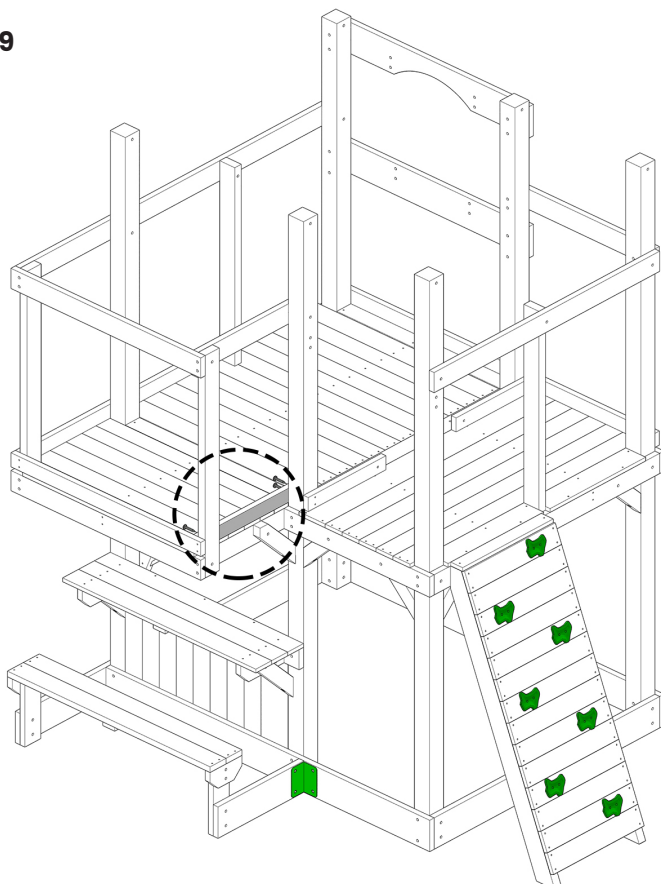

List	
Part NO.	Qty
F18	1
SW50	4

STEP 30

H19 X3

152004 X3

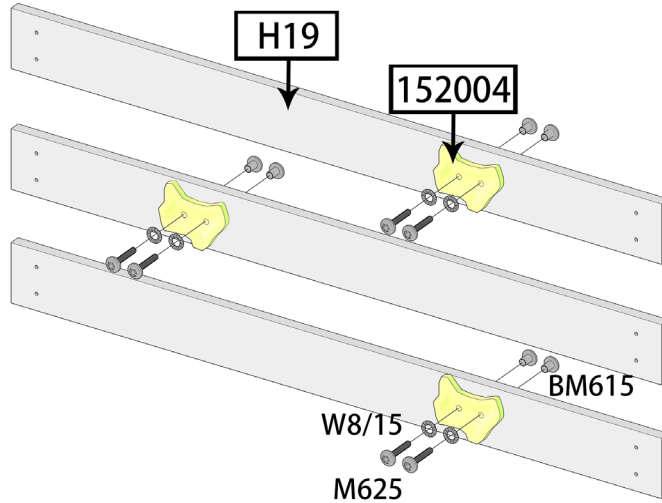

List	
Part NO.	Qty
H19	3
M625	6
W8/15	6
BM615	6
152004	3

STEP 31

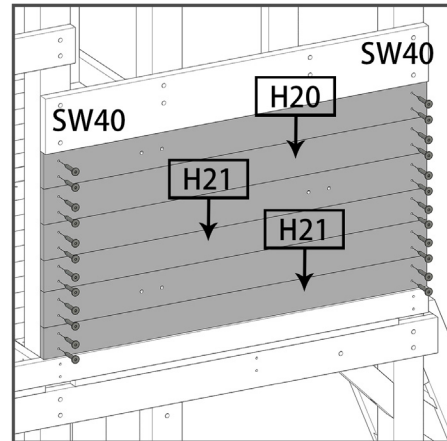
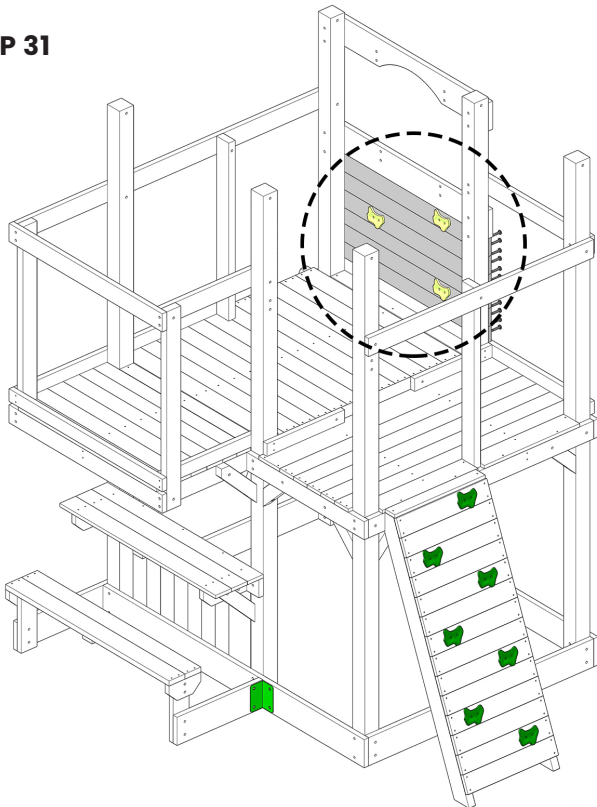

List	
Part NO.	Qty
H20	1
H21	2
SW40	24

STEP 32

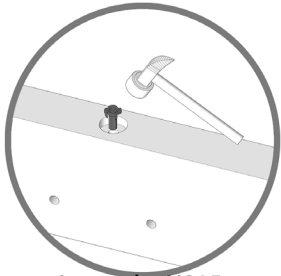
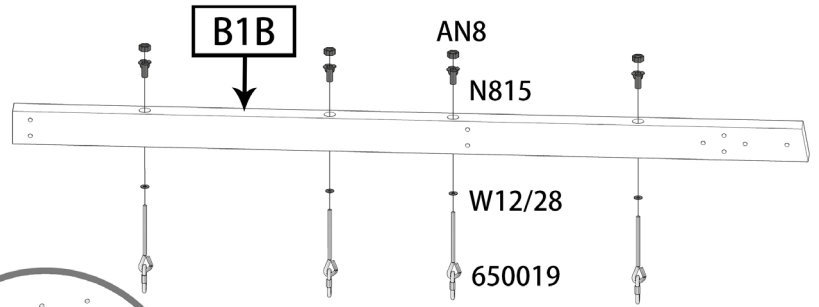

Insert the N815 into the beam by hammer

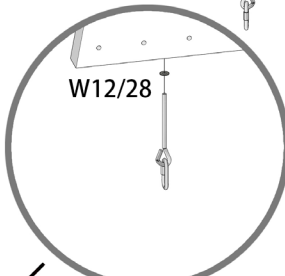

Insert the swing hanger into the beam and fix them with nuts N815 as tightly as possible

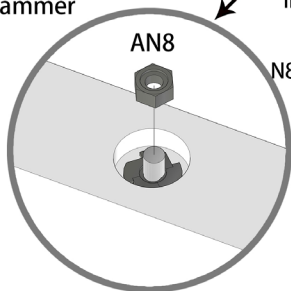

Fix the AN8 as tightly as possible



List	
Part NO.	Qty
B1B	1
AN8	4
N815	4
W12/28	4
650019	4

STEP 33

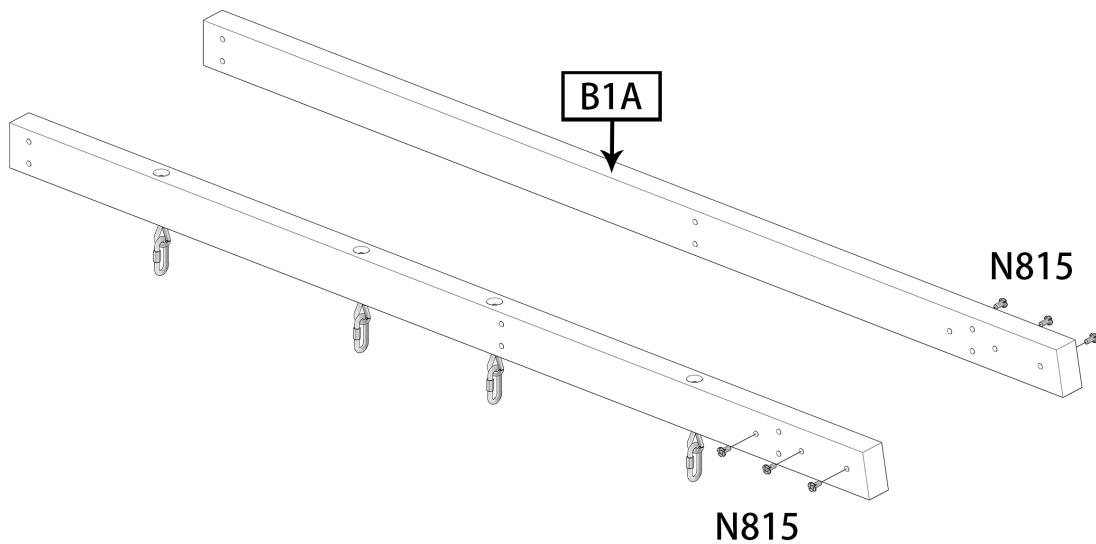

List	
Part NO.	Qty
B1A	1
N815	6

STEP 34

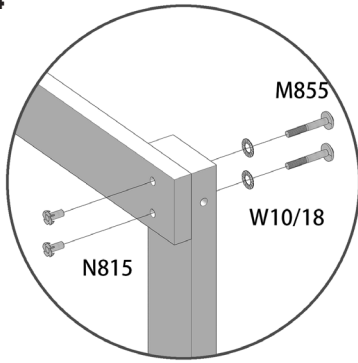

X4

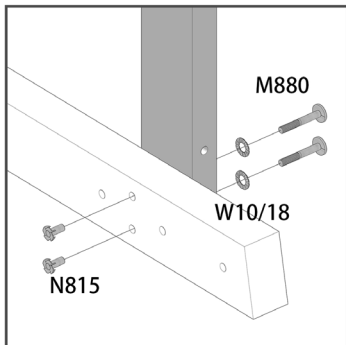

X4

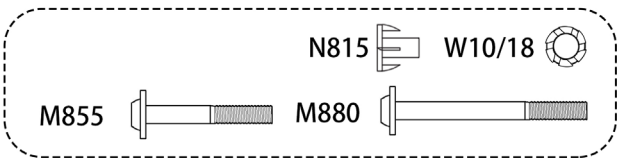
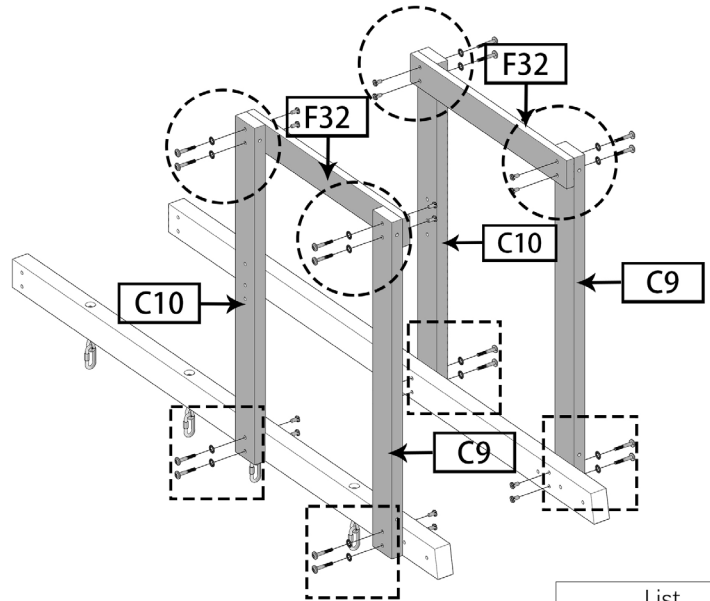

List	
Part NO.	Qty
C9	2
C10	2
F32	2
M855	8
M880	8
W10/18	16
N815	16

STEP 35

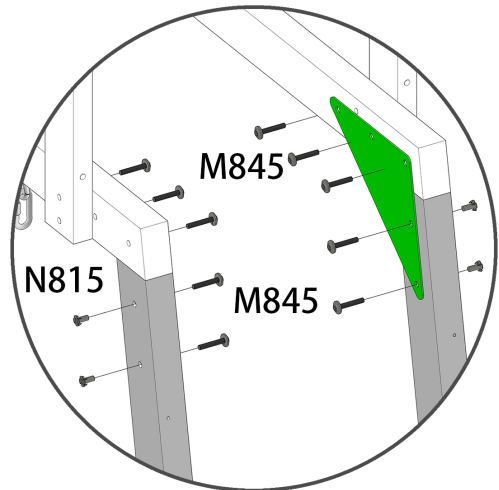
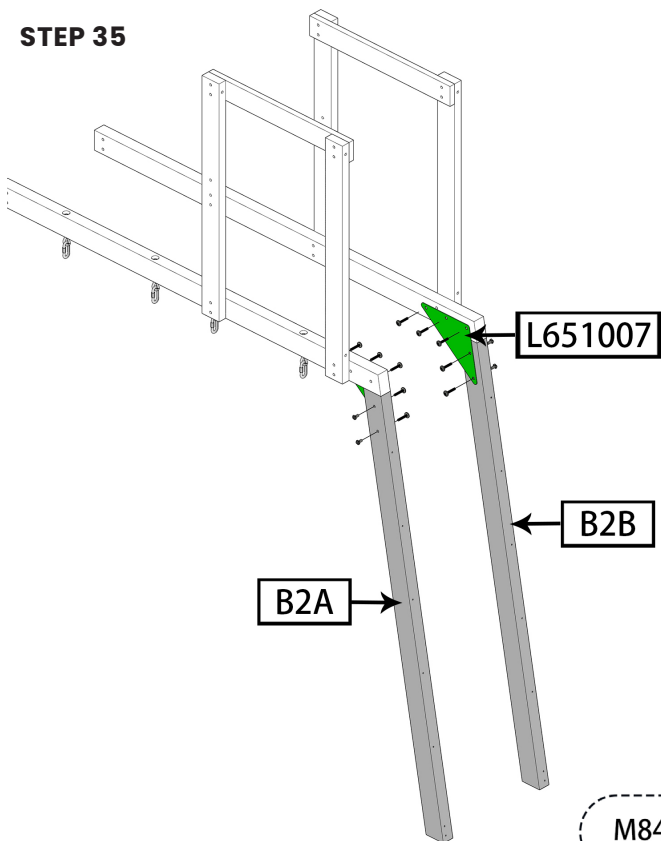

List	
Part NO.	Qty
B2A	1
B2B	1
M845	10
N815	4
L651007	2

STEP 36

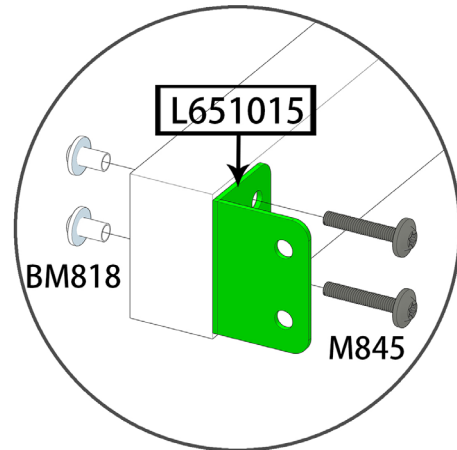
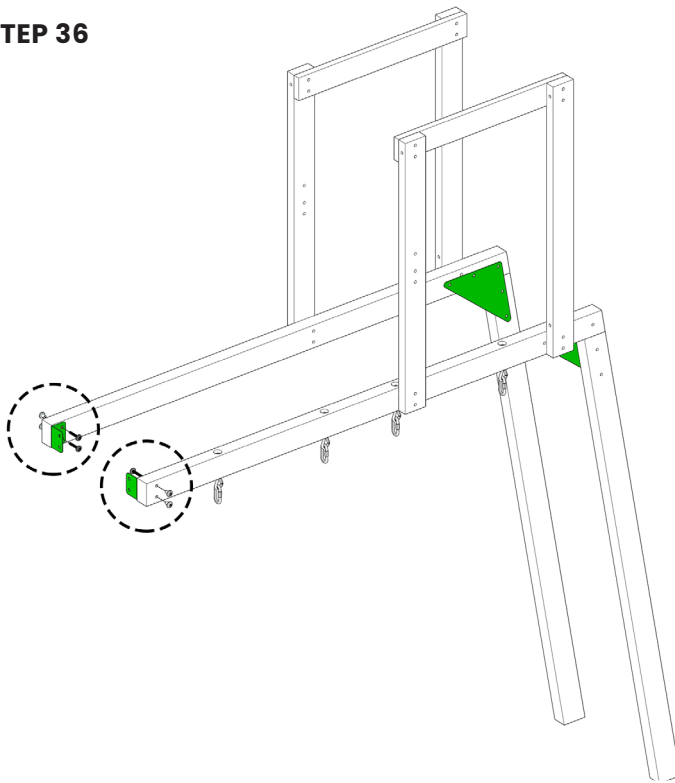

X2

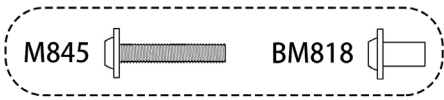

List	
Part NO.	Qty
M845	4
BM818	4
L651015	2

STEP 37

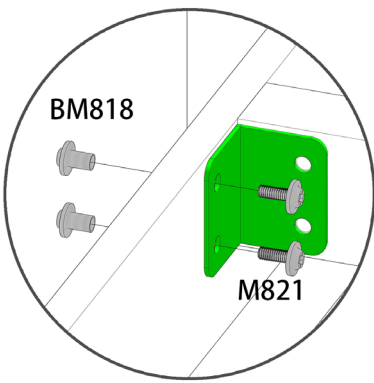

X2

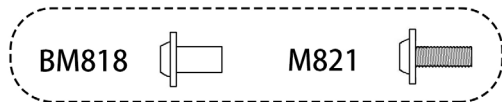
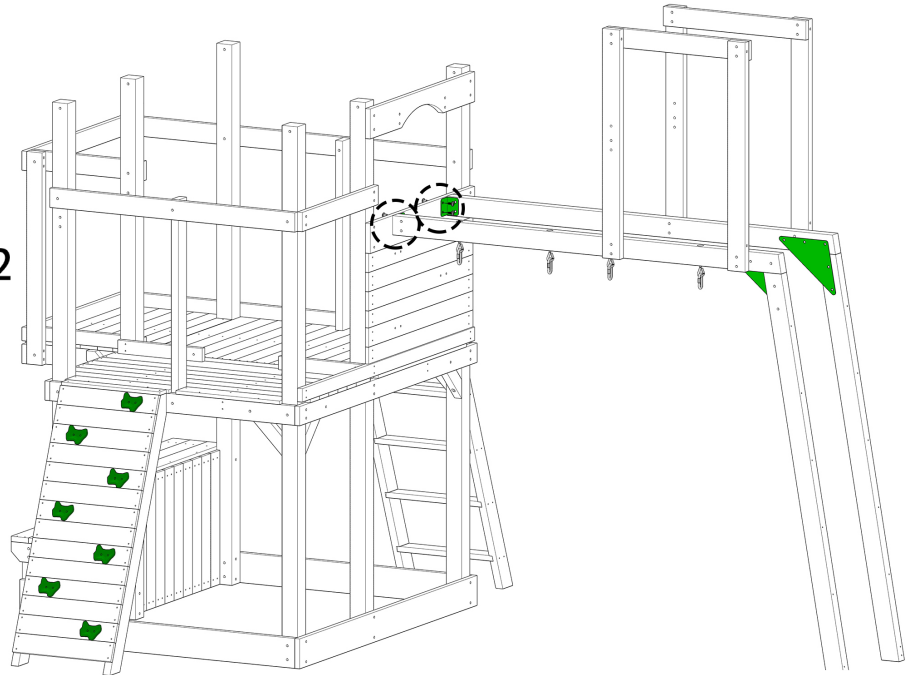

List	
Part NO.	Qty
M821	4
BM818	4

STEP 38

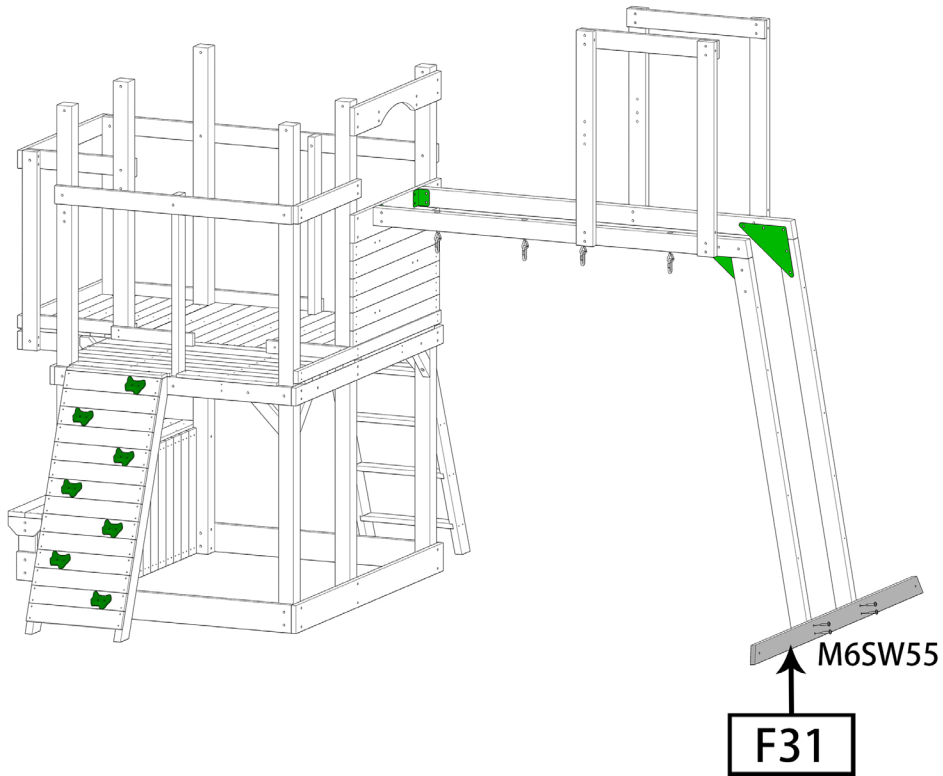

M6SW55 

List	
Part NO.	Qty
F31	1
M6SW55	4

STEP 39

L651006 X5

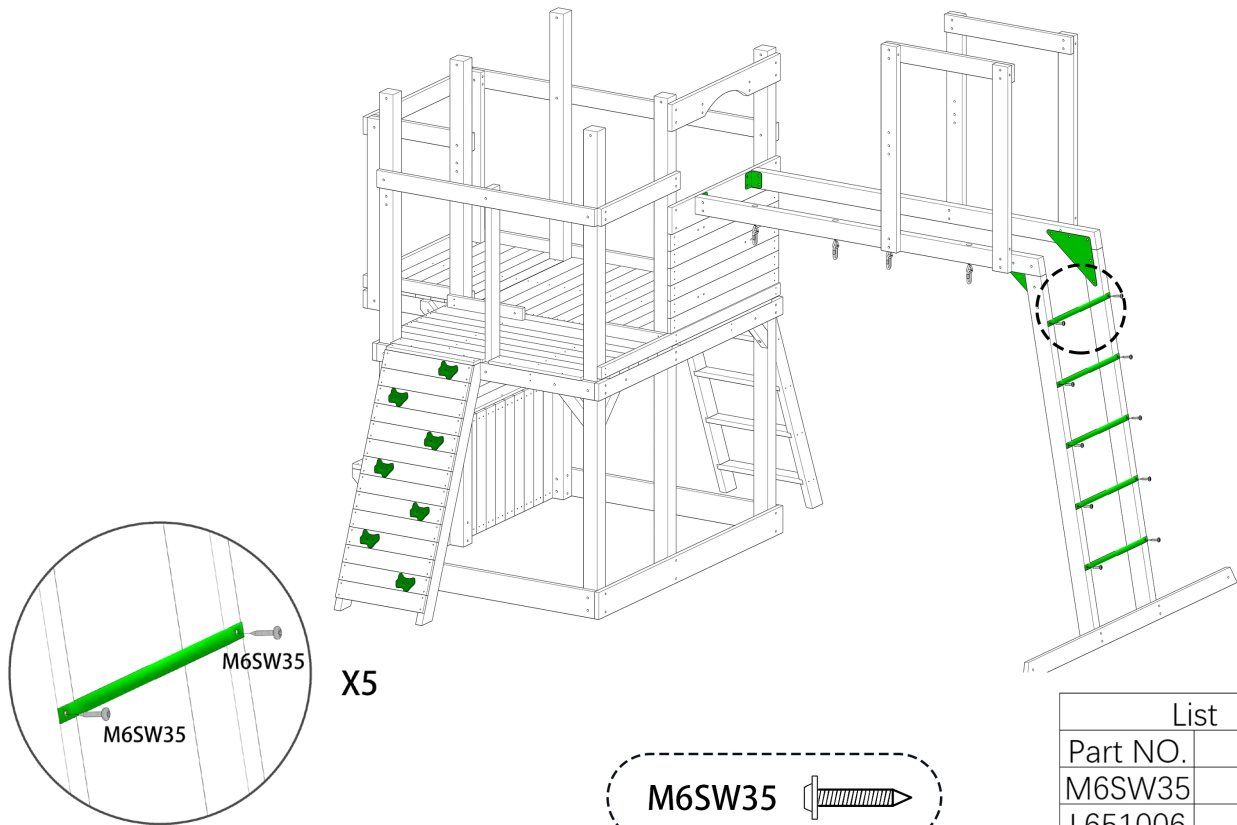

X5

M6SW35 

List	
Part NO.	Qty
M6SW35	10
L651006	5

STEP 40

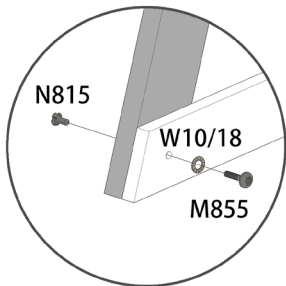

X2

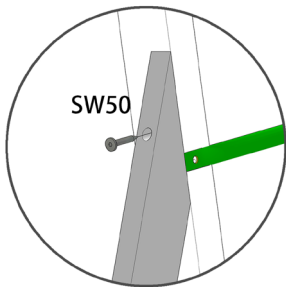

X2

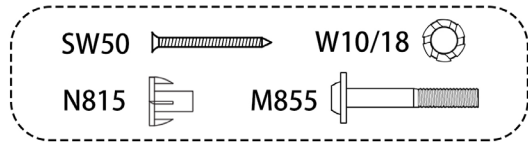
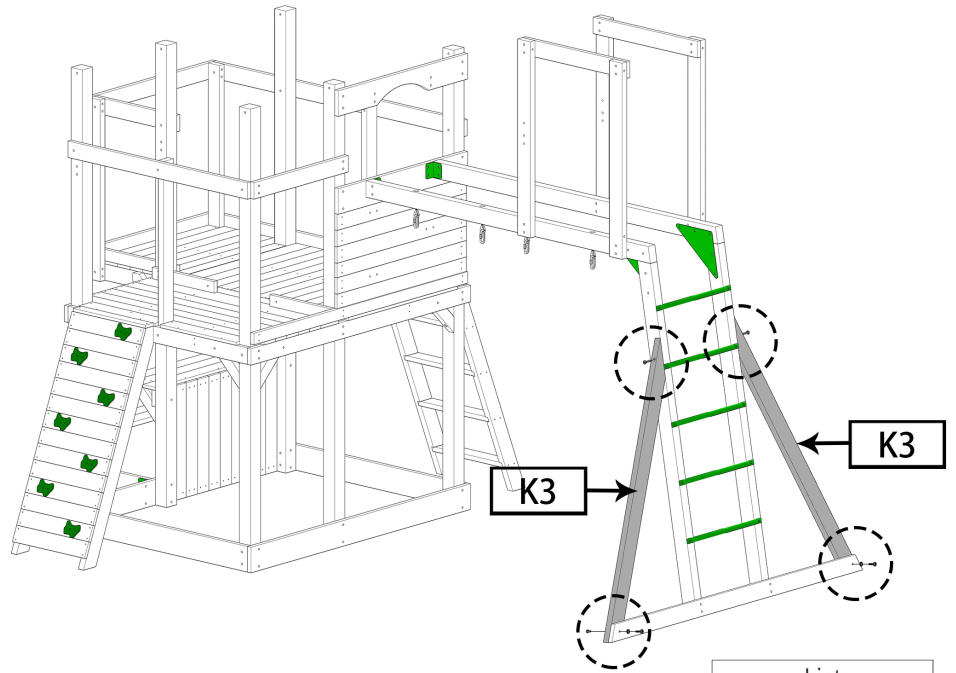

List	
Part NO.	Qty
K3	2
M855	2
W10/18	2
N815	2
SW50	2

STEP 41

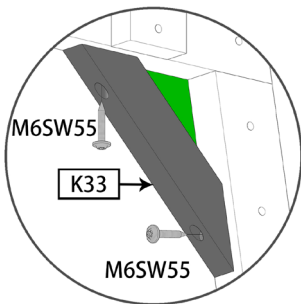

X2

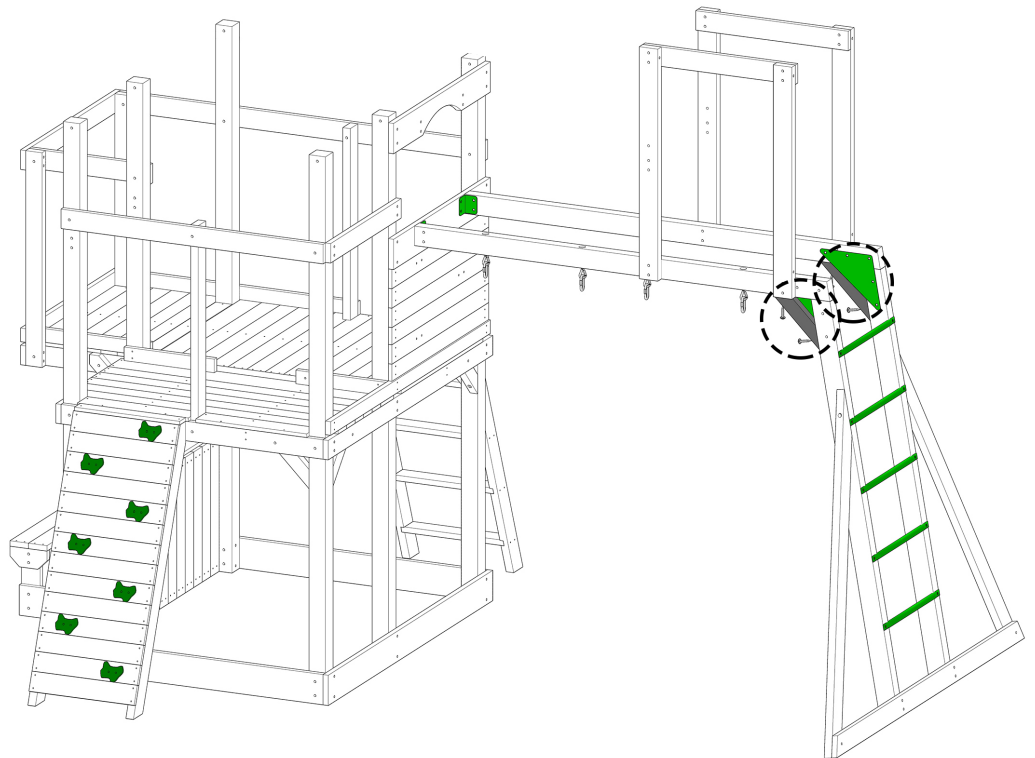

List	
Part NO.	Qty
K33	2
M6SW55	4

STEP 42

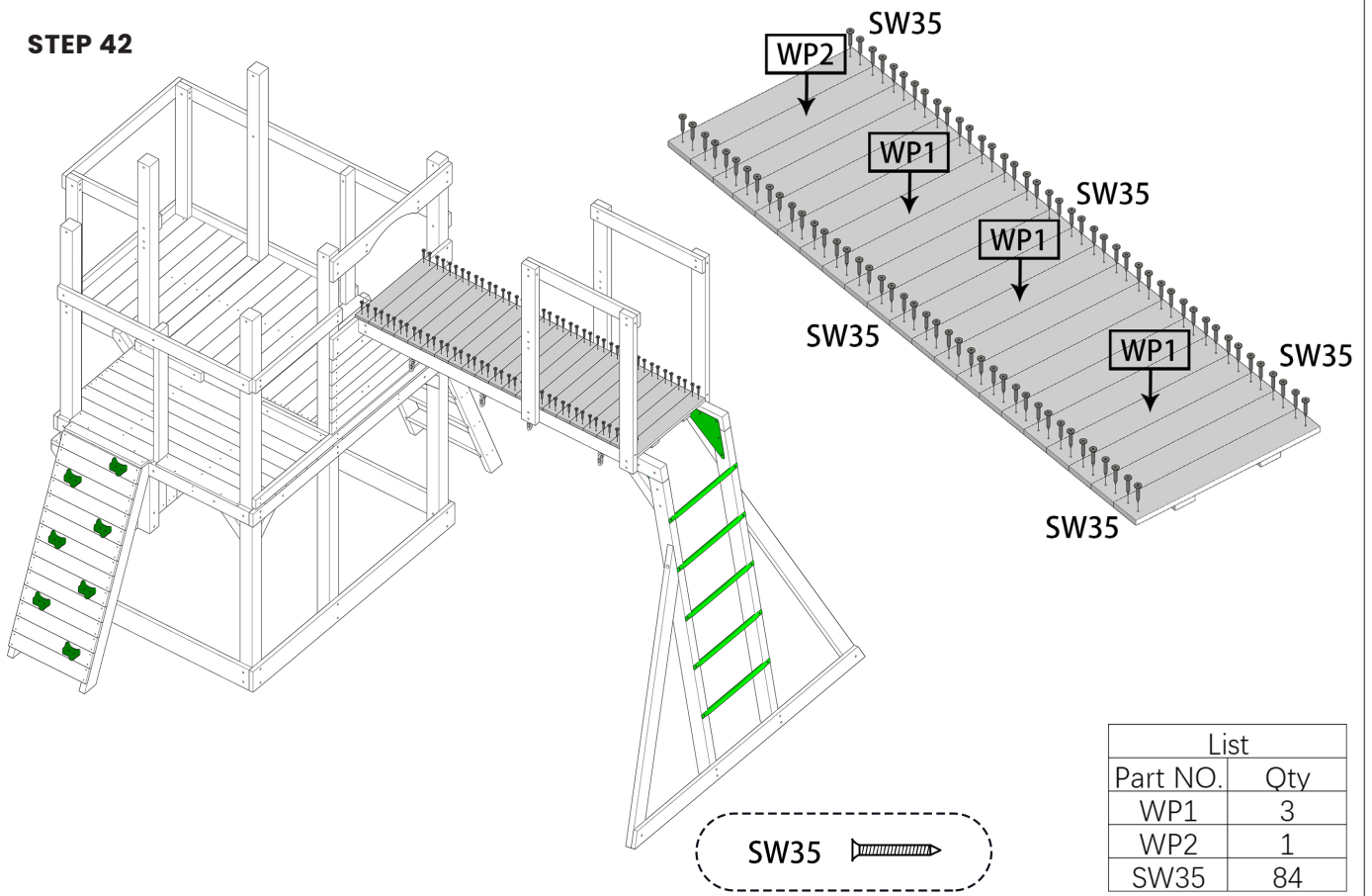

List	
Part NO.	Qty
WP1	3
WP2	1
SW35	84

STEP 43

F34 X2
L651015 X2

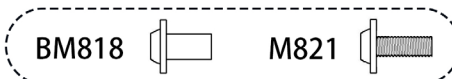
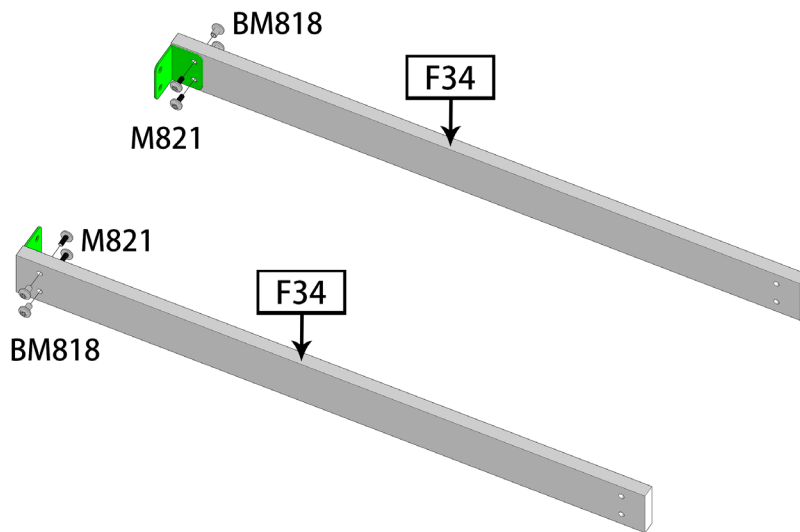

List	
Part NO.	Qty
F34	2
M821	4
BM818	4
L651015	2

STEP 44

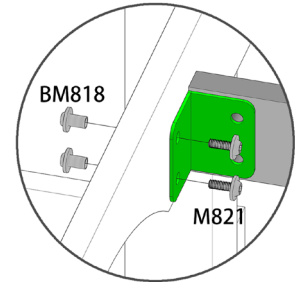
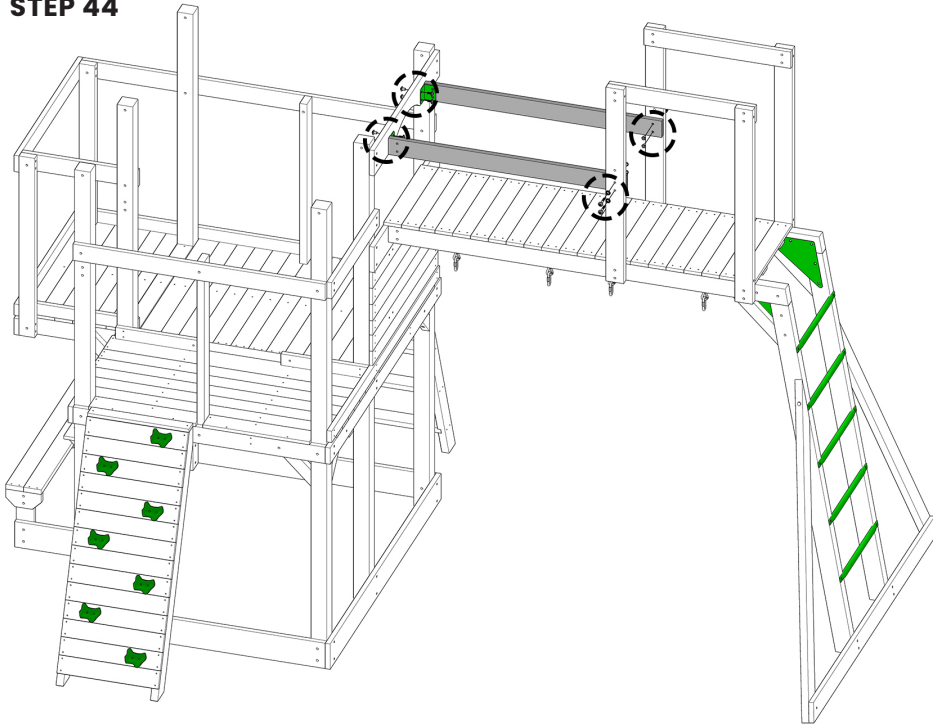

X2

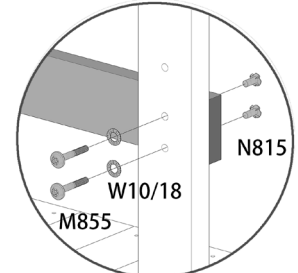

X2

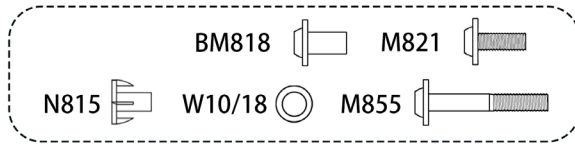

List	
Part NO.	Qty
M855	4
W10/18	4
N815	4
M821	4
BM818	4

STEP 45

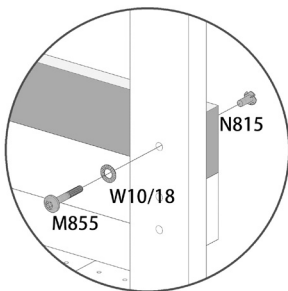
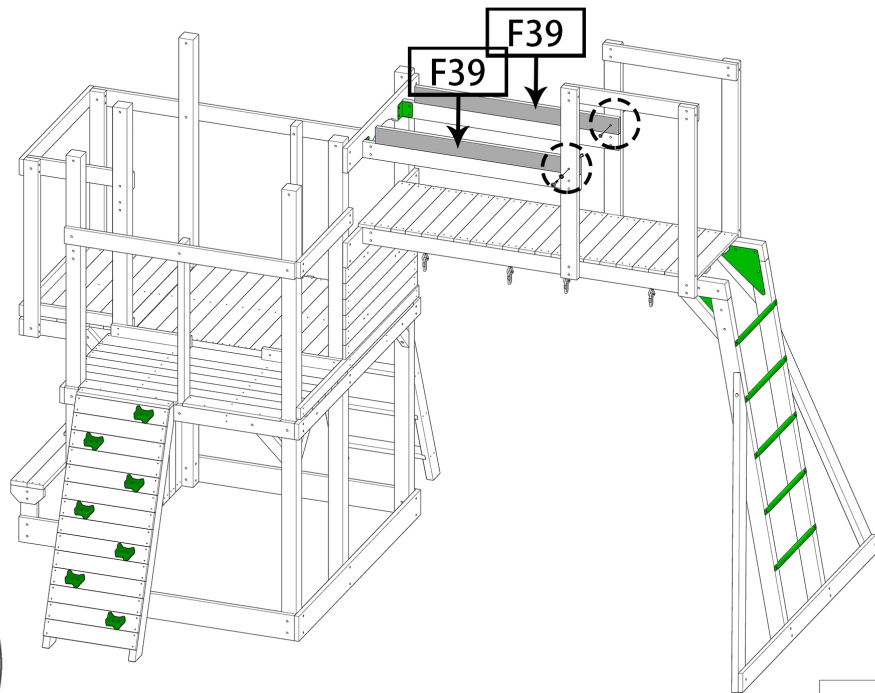

X2



List	
Part NO.	Qty
F39	2
M855	2
W10/18	2
N815	2

STEP 46

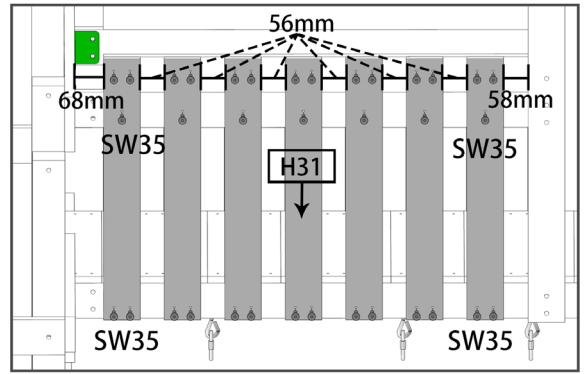
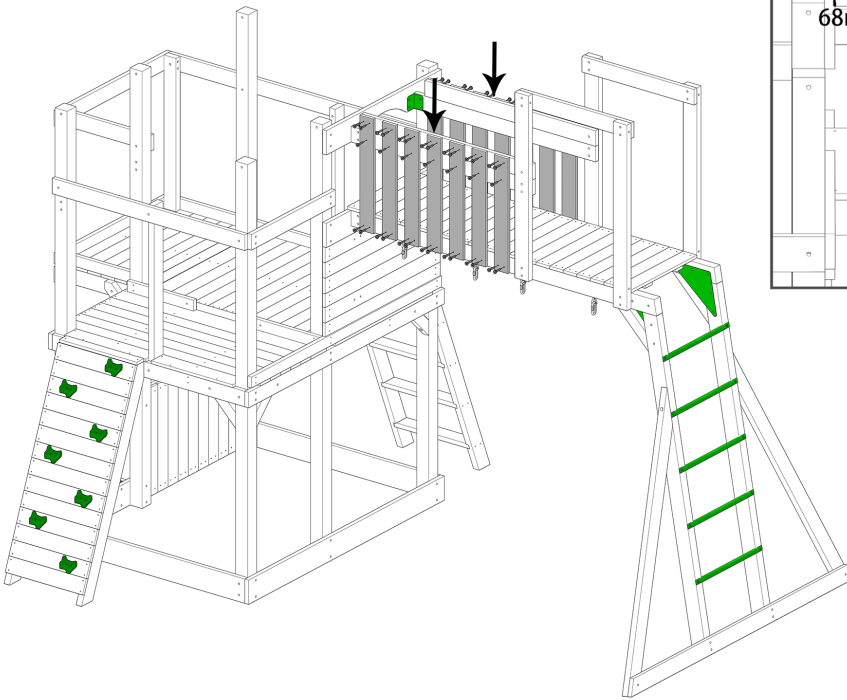

X2



List	
Part NO.	Qty
H31	14
SW35	70

STEP 47

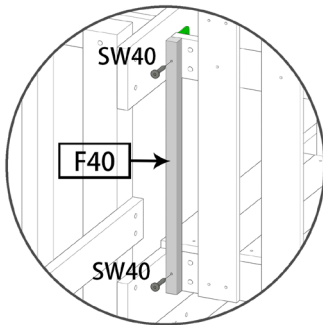
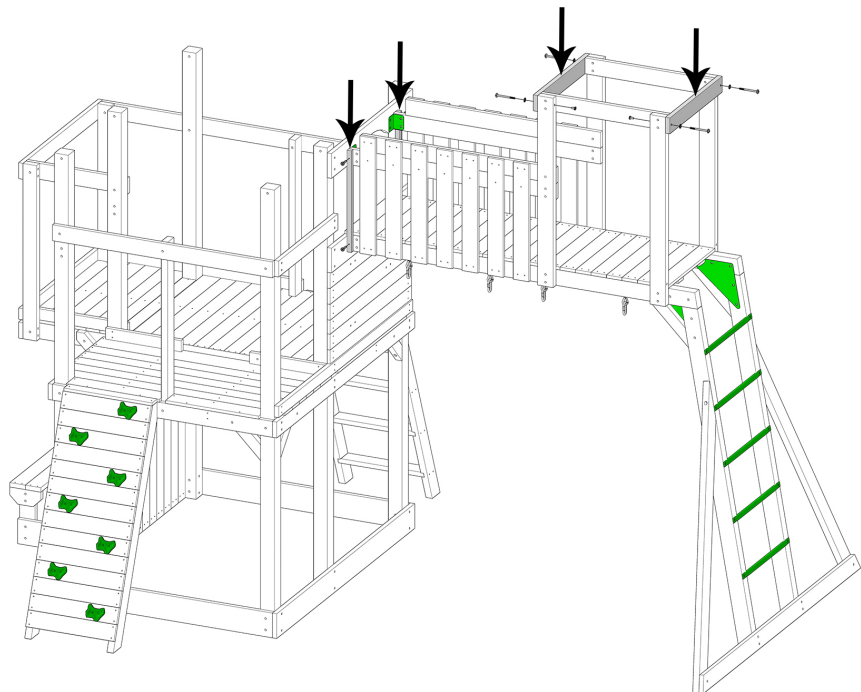

X2

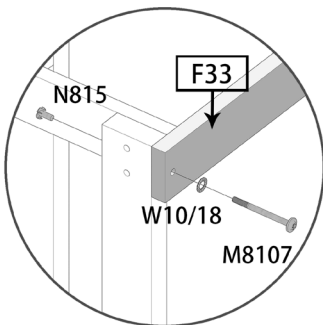

X4

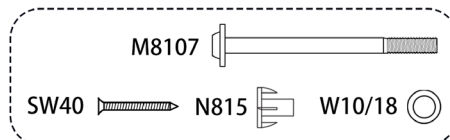

List	
Part NO.	Qty
F33	2
F40	2
M8107	4
W10/18	4
N815	4
SW40	4

STEP 48

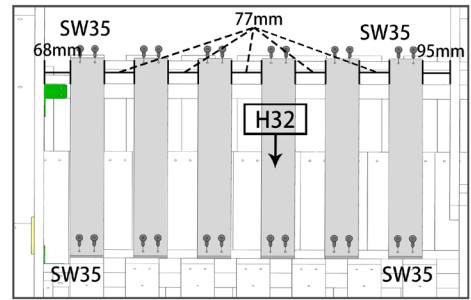
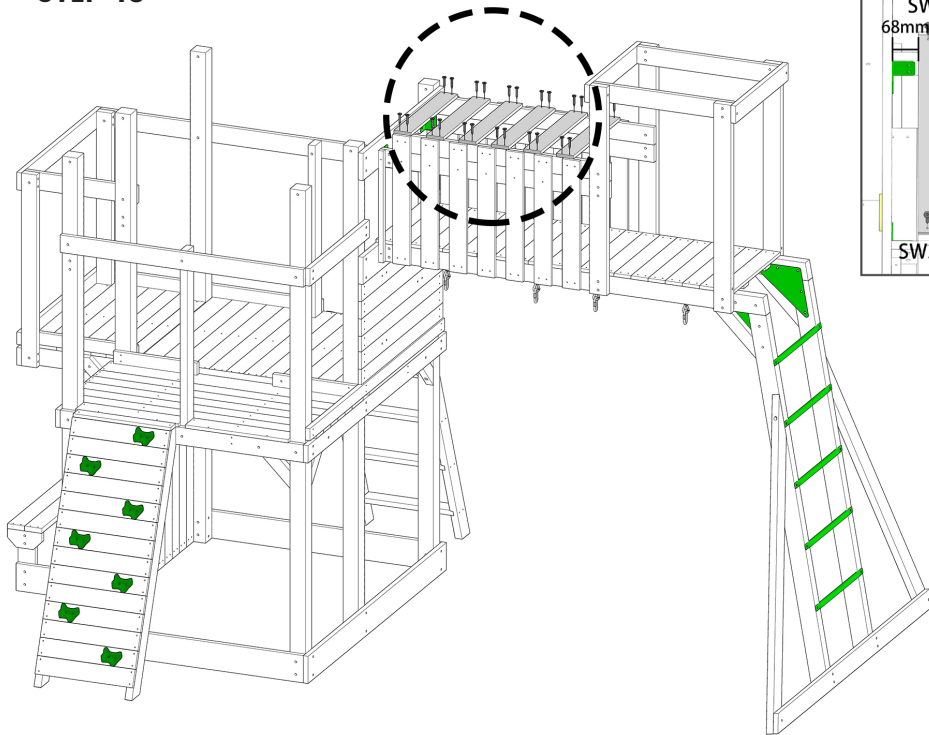

List	
Part NO.	Qty
H32	6
SW35	24

STEP 49

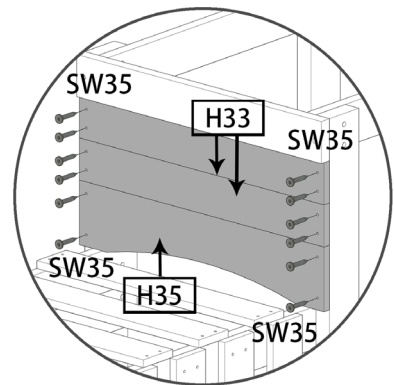
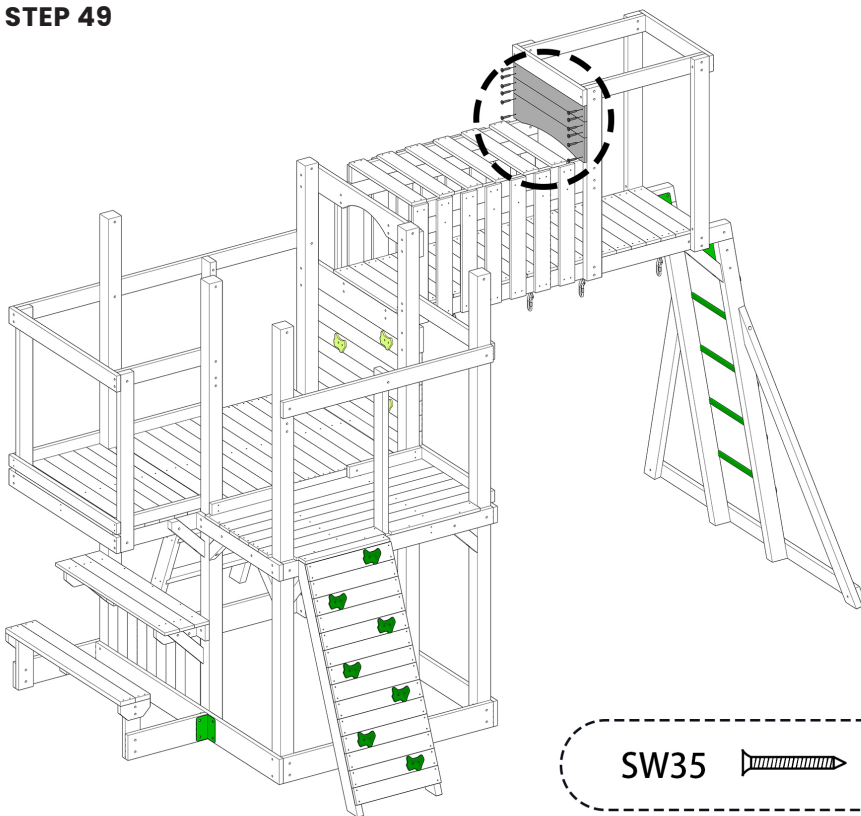

List	
Part NO.	Qty
H33	2
H35	1
SW35	12

STEP 50

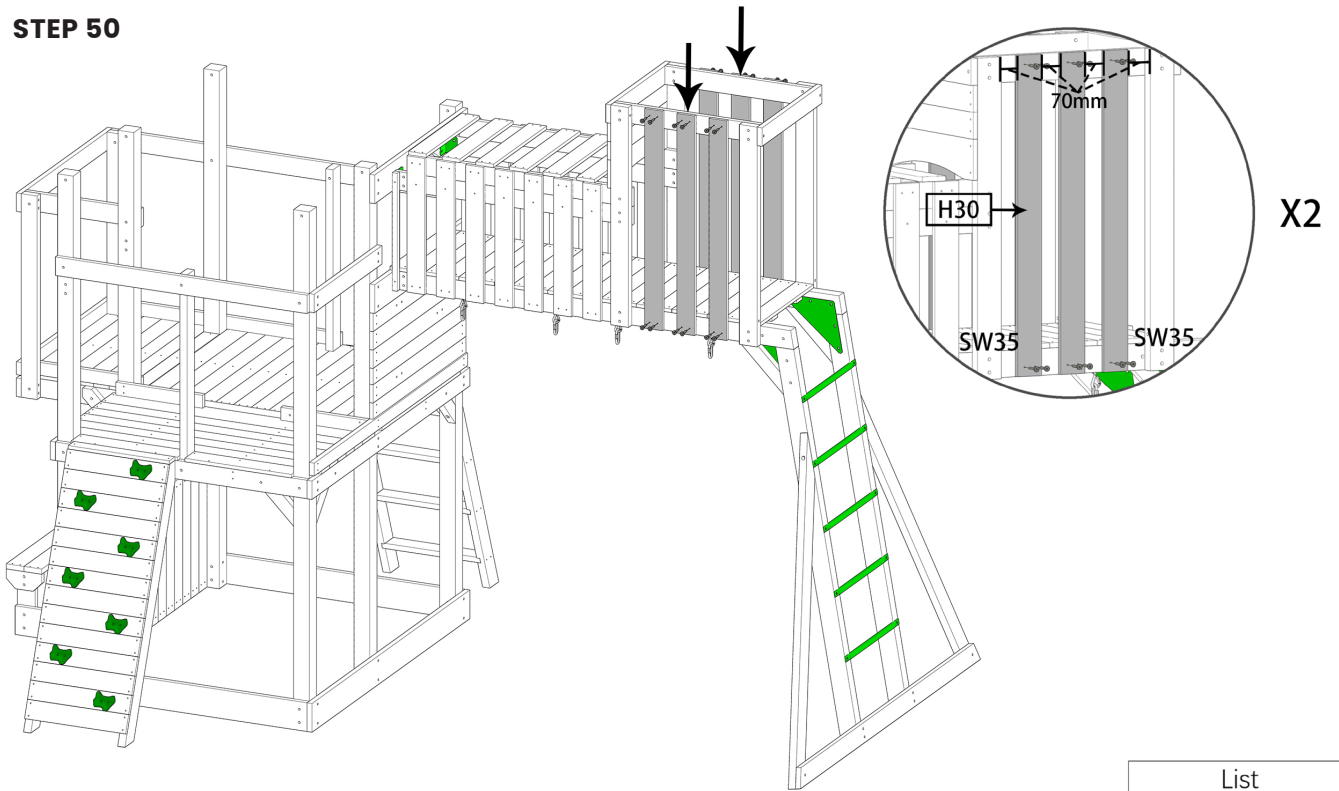

X2



List	
Part NO.	Qty
H30	6
SW35	24

STEP 51

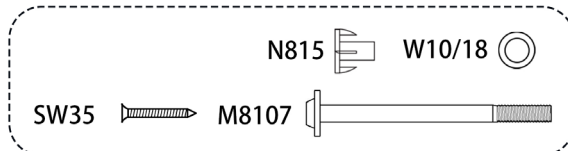
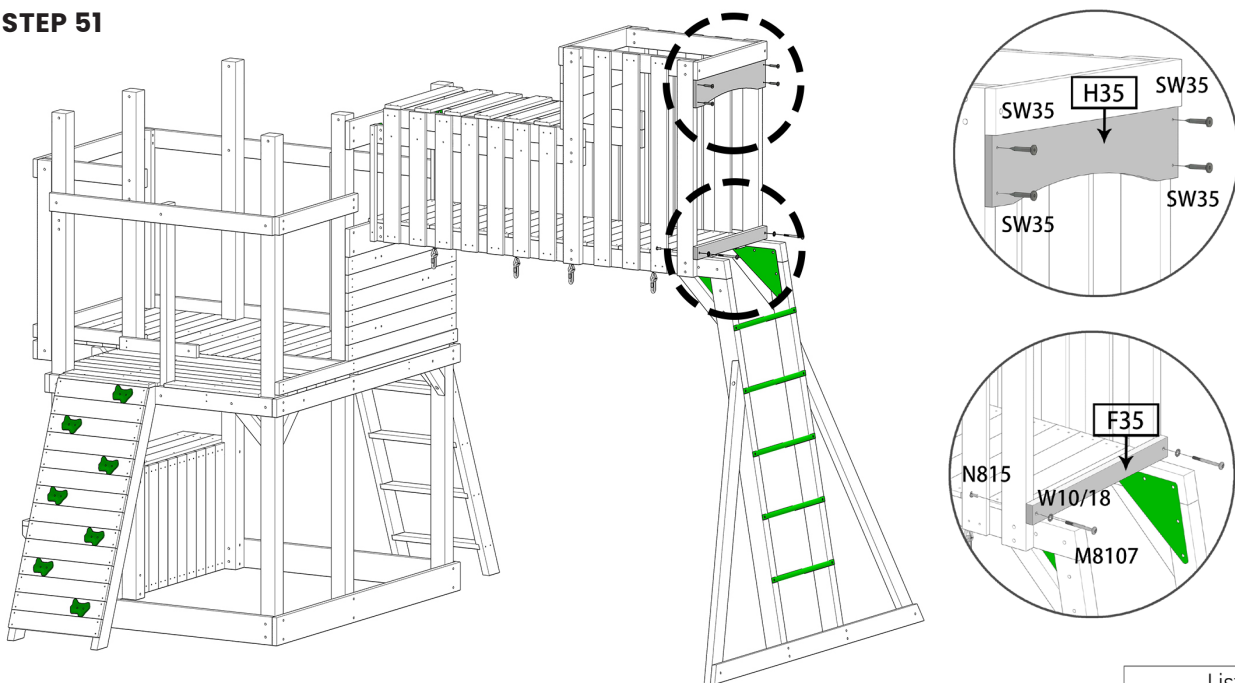

List	
Part NO.	Qty
F35	1
H35	1
SW35	4
M8107	2
W10/18	2
N815	2

STEP 52

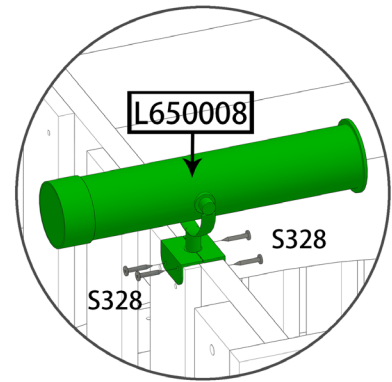
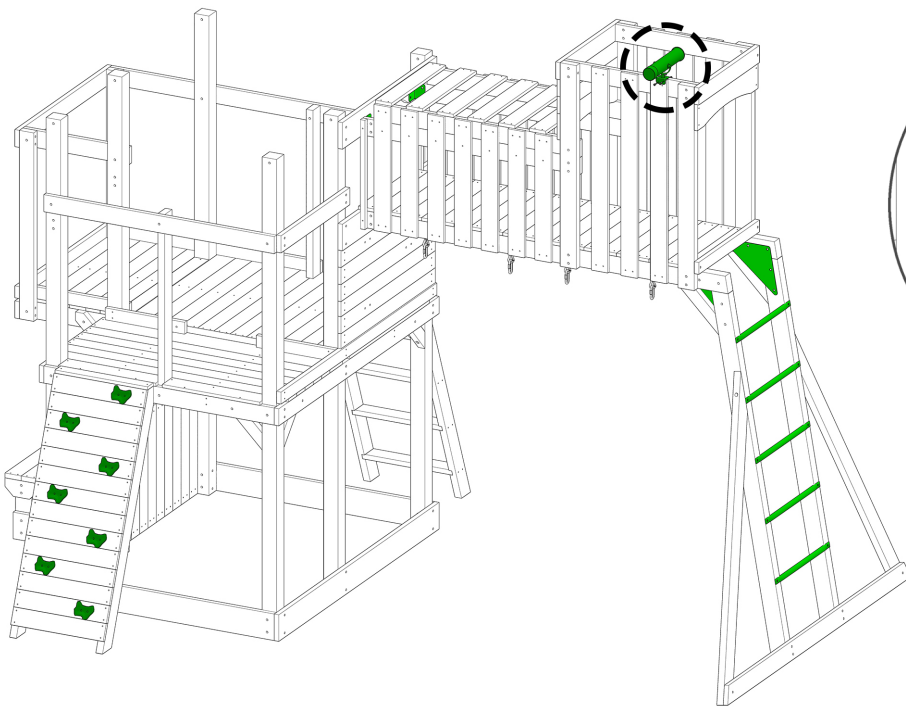

List	
Part NO.	Qty
S328	4
L650008	1

STEP 53

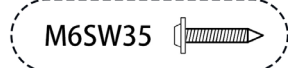
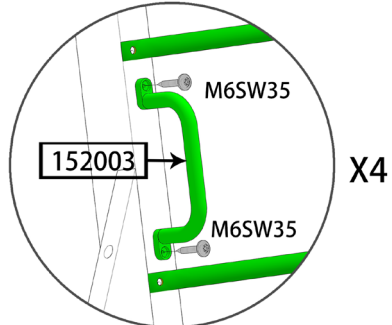
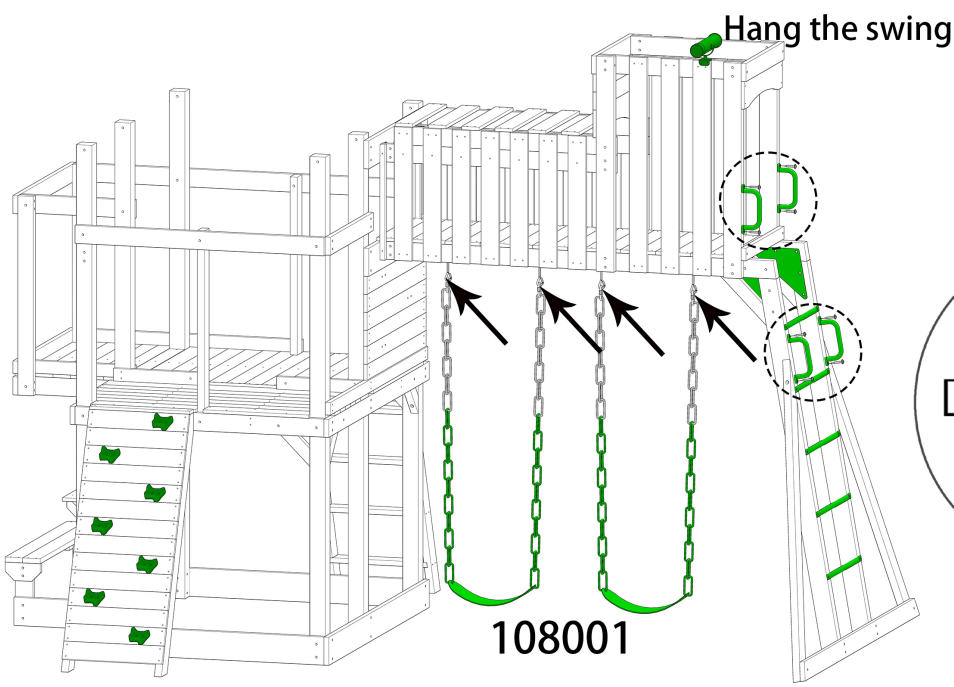

List	
Part NO.	Qty
M6SW35	8
152003	4
108001	2

STEP 54

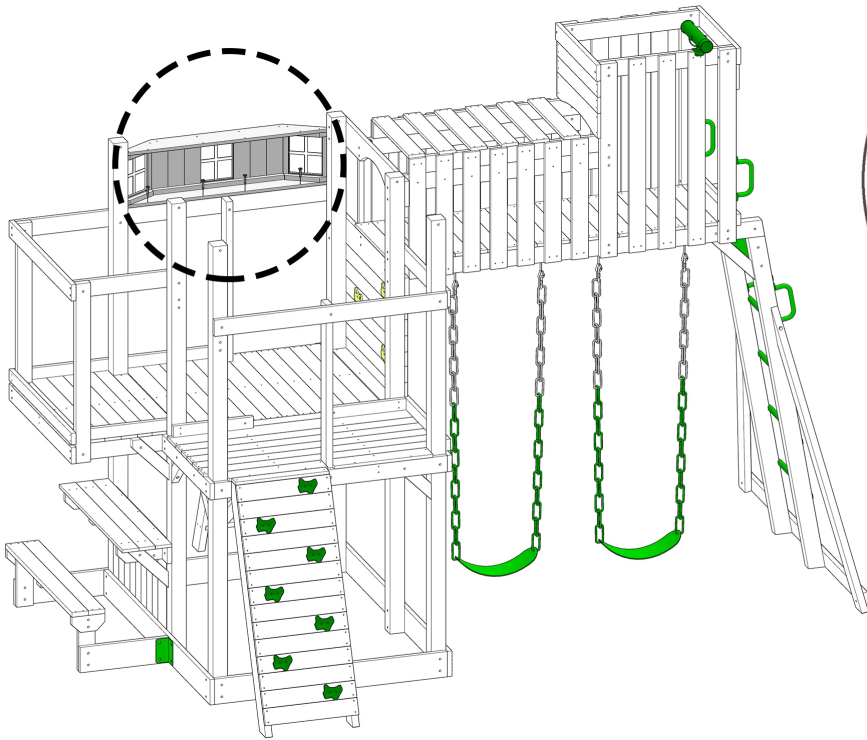

List	
Part NO.	Qty
SILL	1
SW35	4

STEP 55

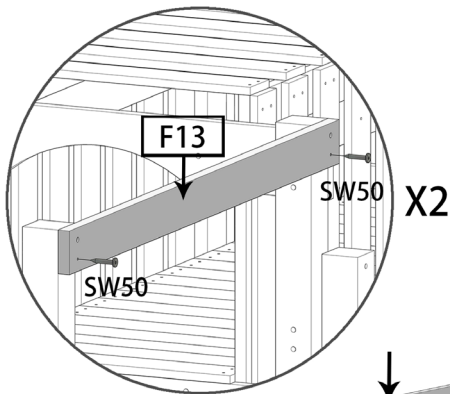

Note that the two holes of diameter 10 are open

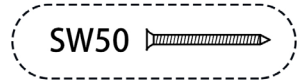
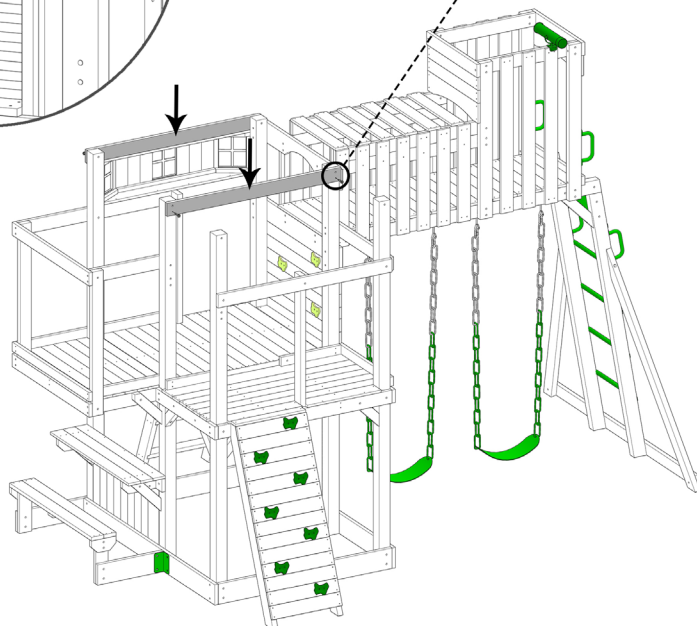

List	
Part NO.	Qty
F13	2
SW50	4

STEP 56

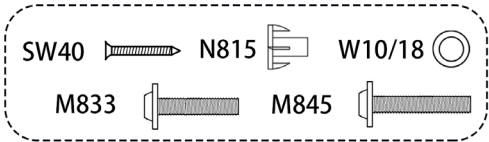
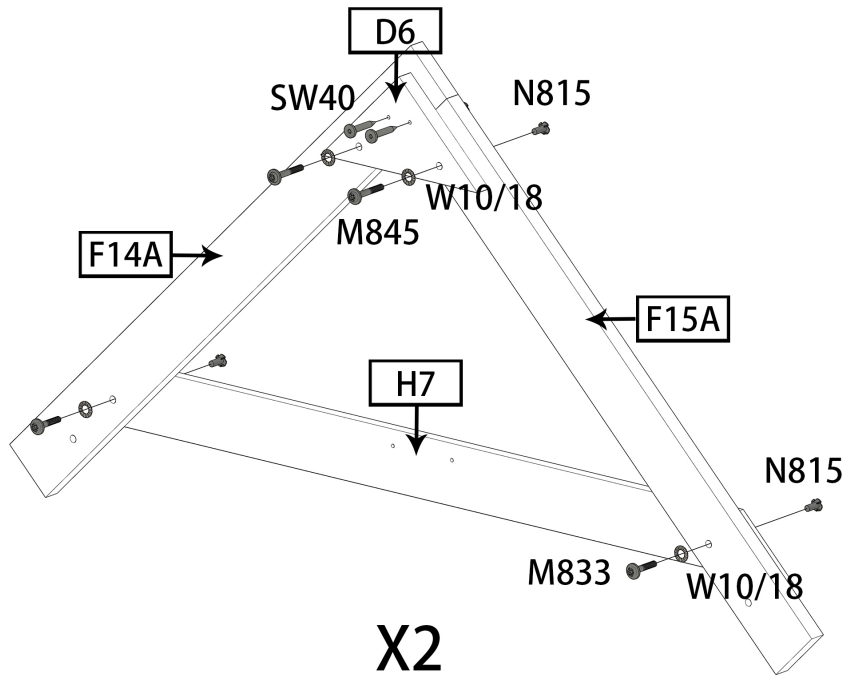

List	
Part NO.	Qty
D6	2
H7	2
F14A	2
F15A	2
SW40	4
M833	4
M845	4
W10/18	8
N815	8

STEP 57

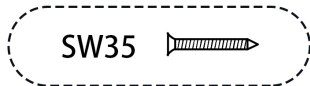
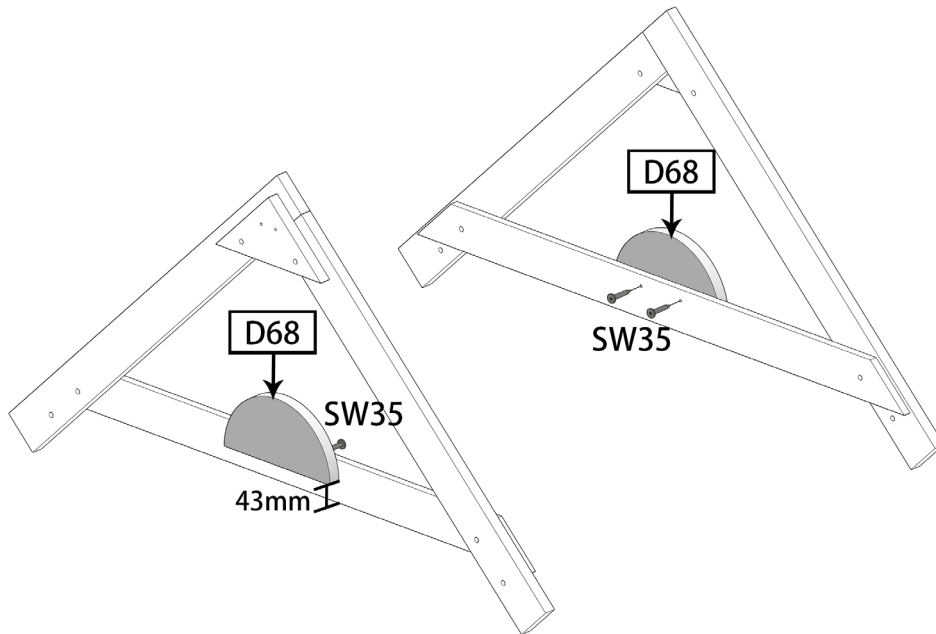

List	
Part NO.	Qty
D68	2
SW35	4

STEP 58

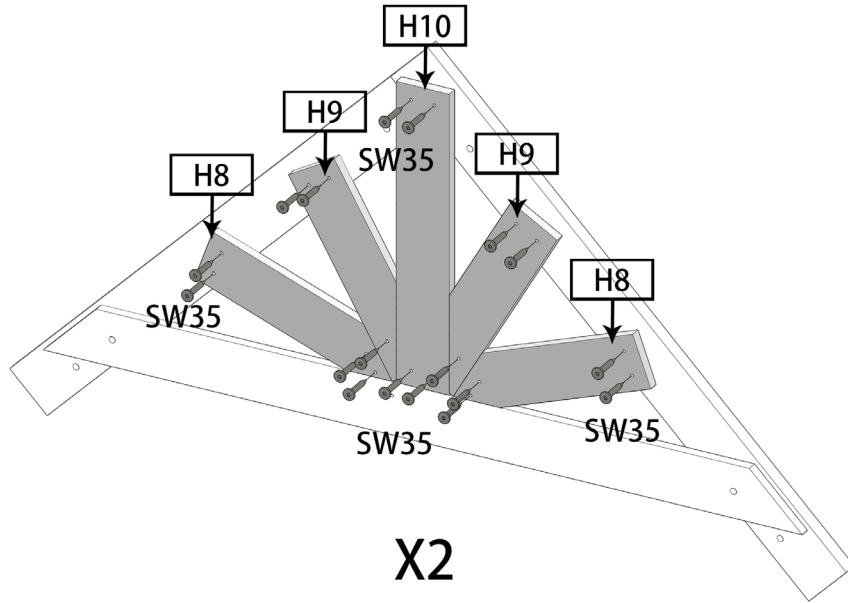

List	
Part NO.	Qty
H8	4
H9	4
H10	2
SW35	36



STEP 59

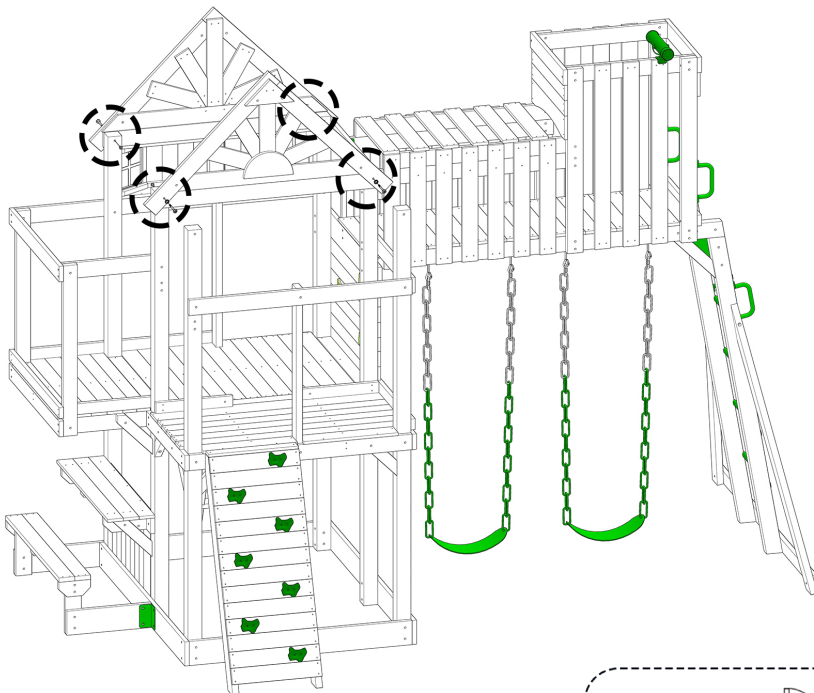

X4

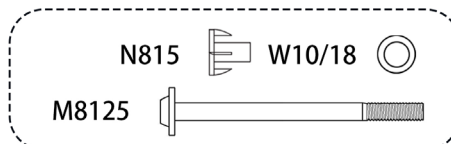

List	
Part NO.	Qty
M8125	4
W10/18	4
N815	4

STEP 60

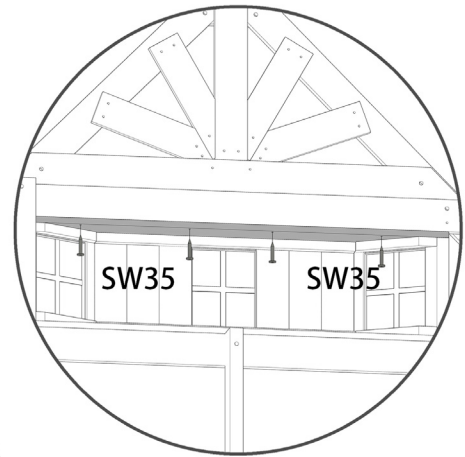
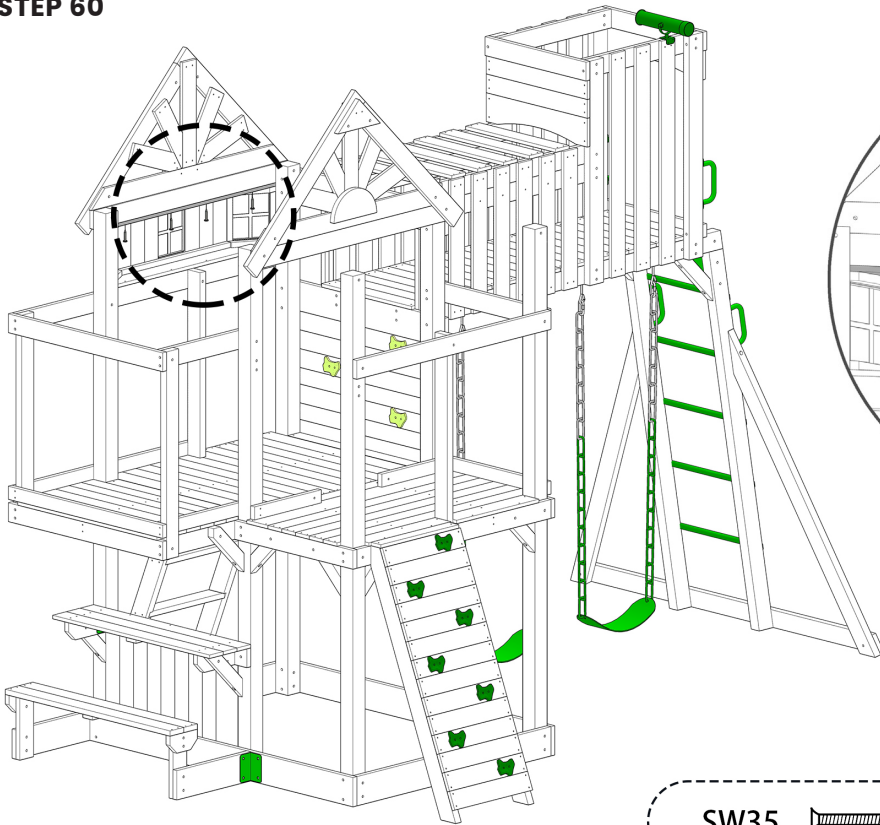

List	
Part NO.	Qty
SW35	4

STEP 61

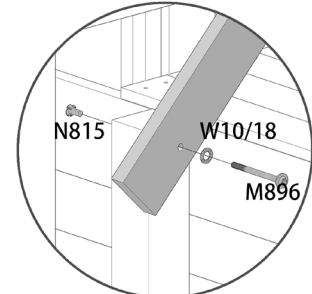
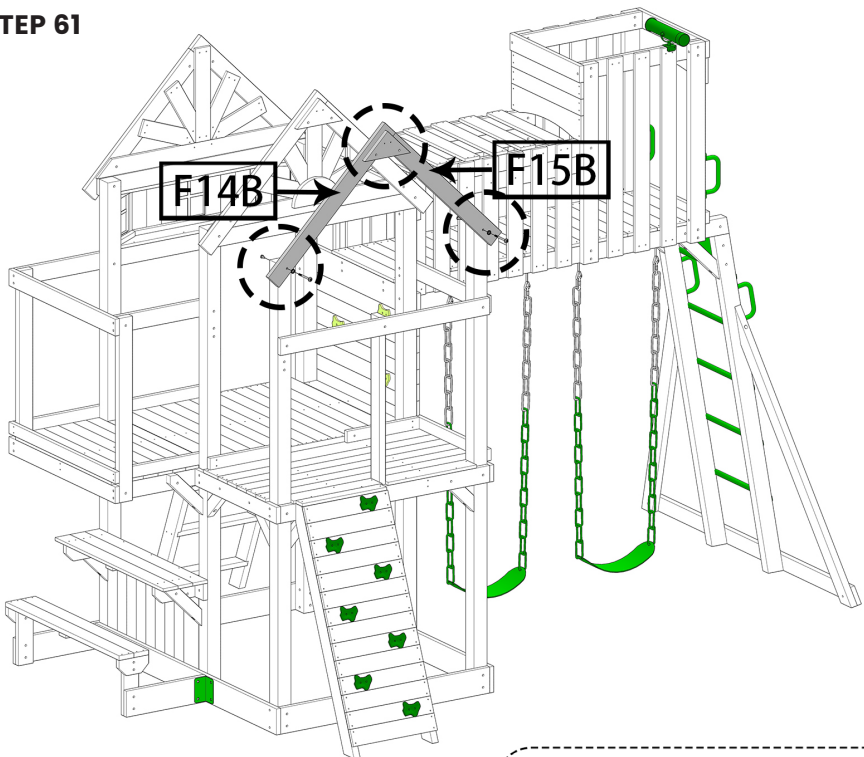

X2

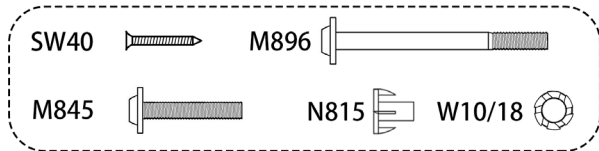
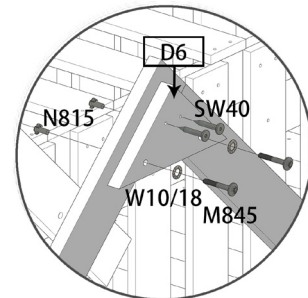

List	
Part NO.	Qty
M896	2
W10/18	4
N815	4
D6	1
F14B	1
F15B	1
SW40	2
M845	2

STEP 62

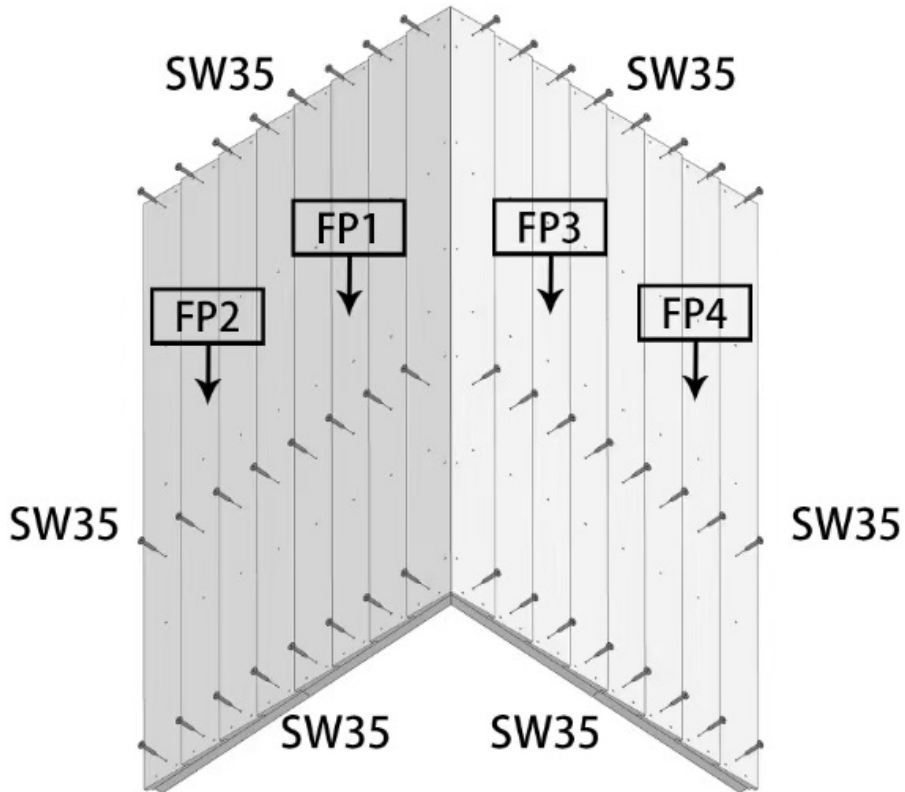

Put FP3 and FP4 together first, and then lock the screws

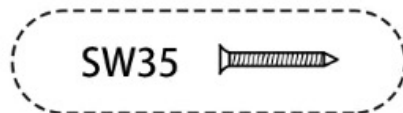
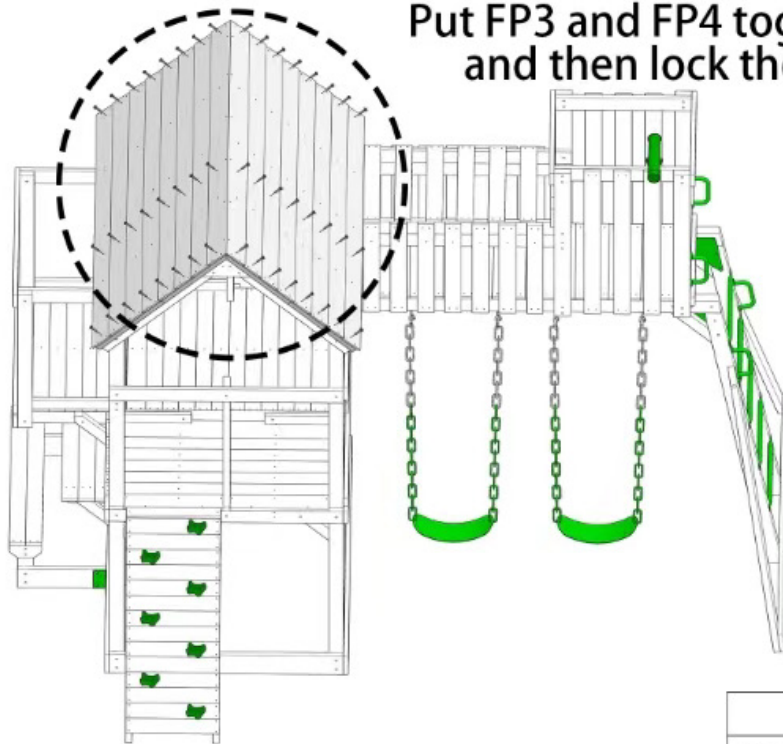

List	
Part NO.	Qty
FP1	1
FP2	1
FP3	1
FP4	1
SW35	48

STEP 63

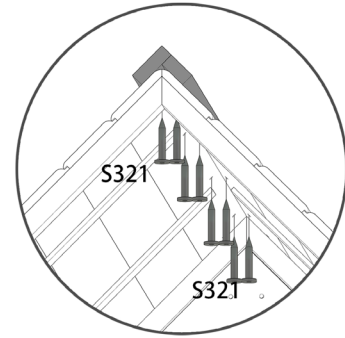
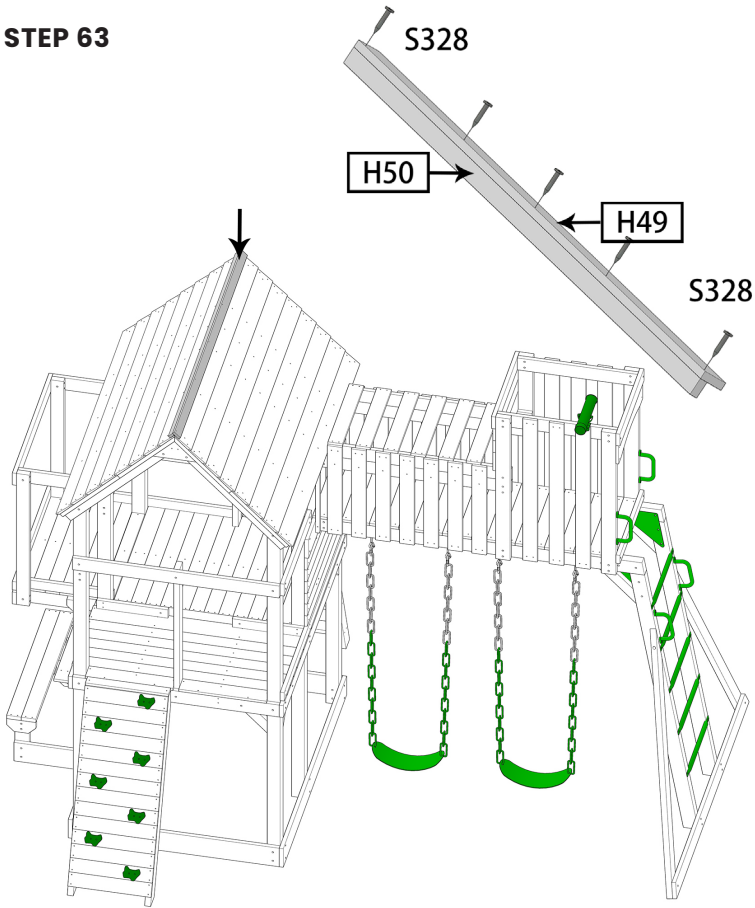

Screws lock from the bottom of the roof

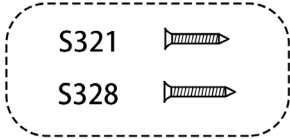

List	
Part NO.	Qty
H49	1
H50	1
S328	5
S321	8

STEP 64

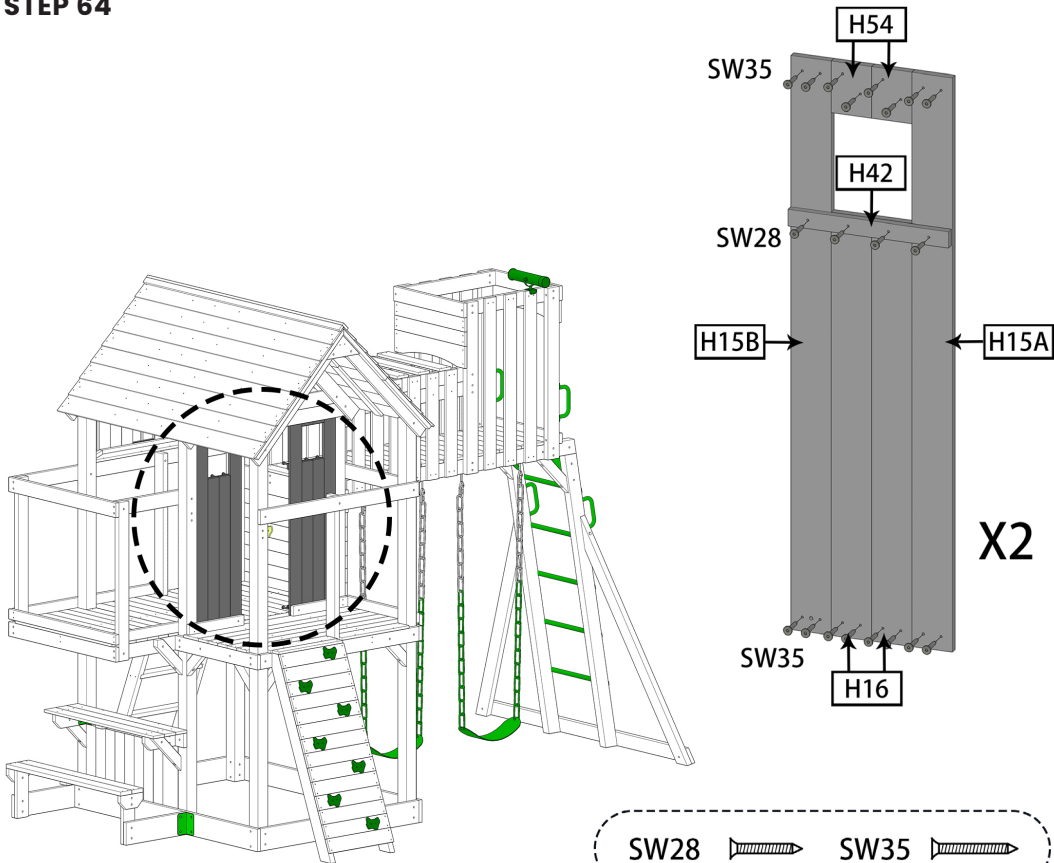

List	
Part NO.	Qty
H15A	2
H15B	2
H16	4
H42	2
H54	4
SW28	8
SW35	32



STEP 65

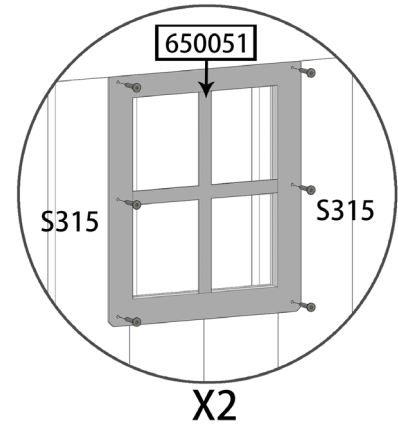
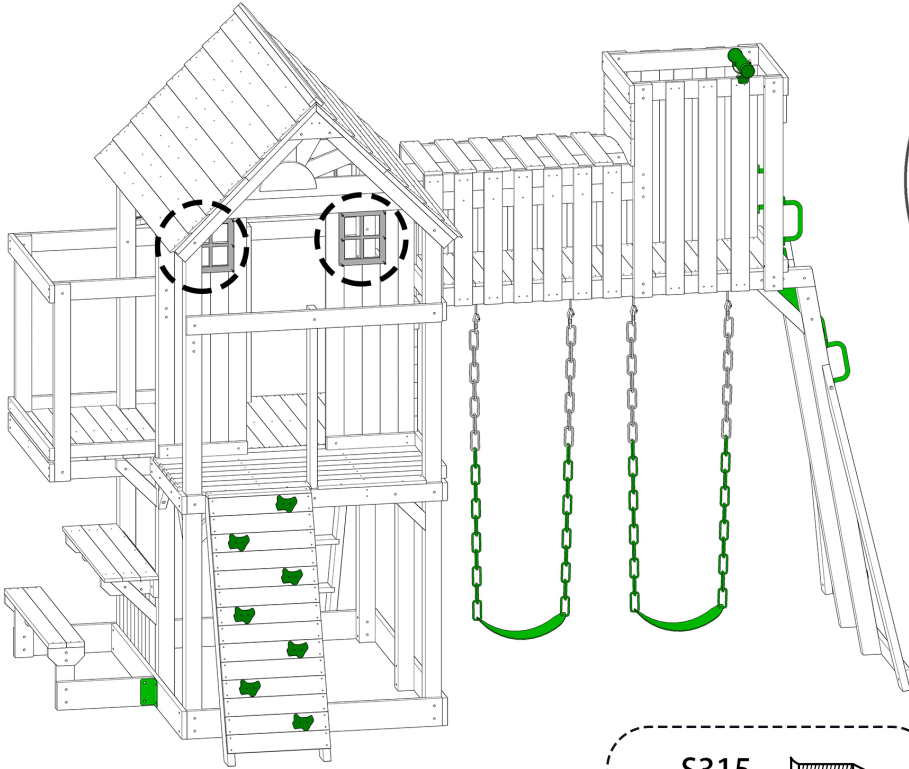

X2

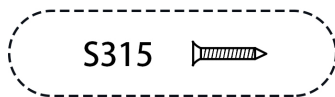

List	
Part NO.	Qty
S315	12
650051	2

STEP 66

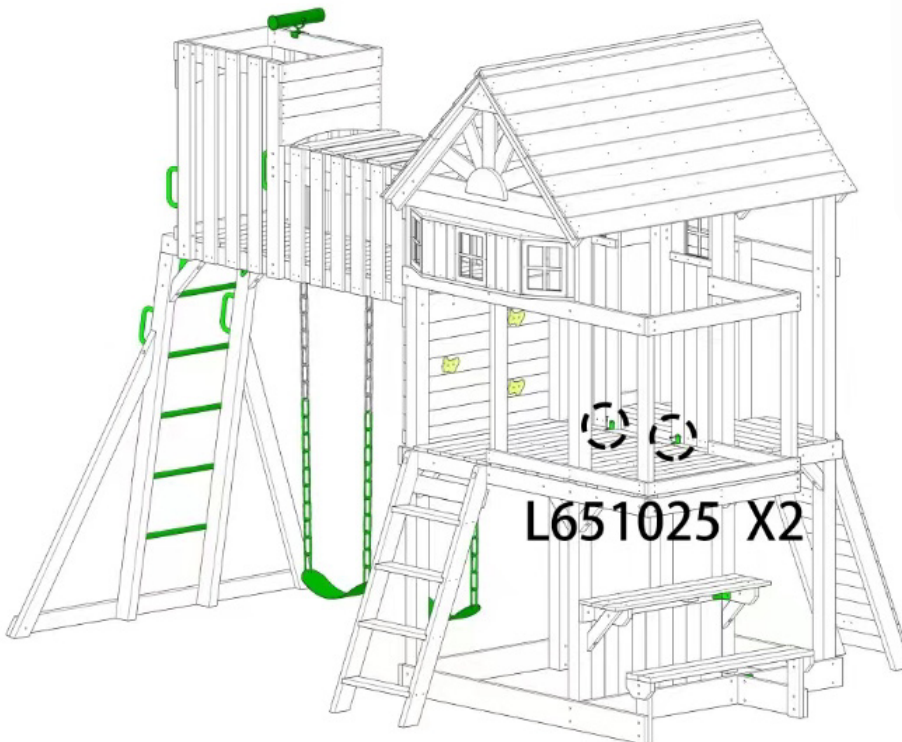

L651025 X2

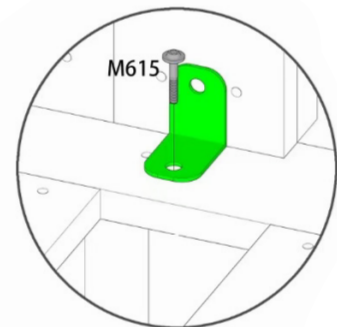

X2

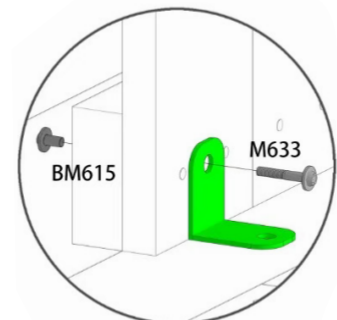

X2

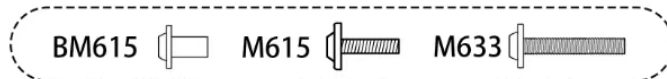

List	
Part NO.	Qty
M615	2
M633	2
BM615	2
L651025	2

STEP 67

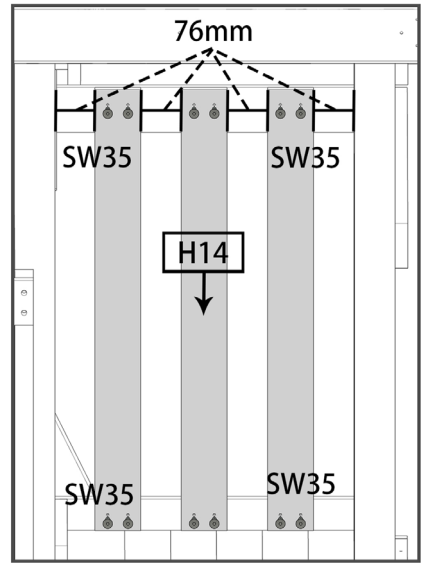
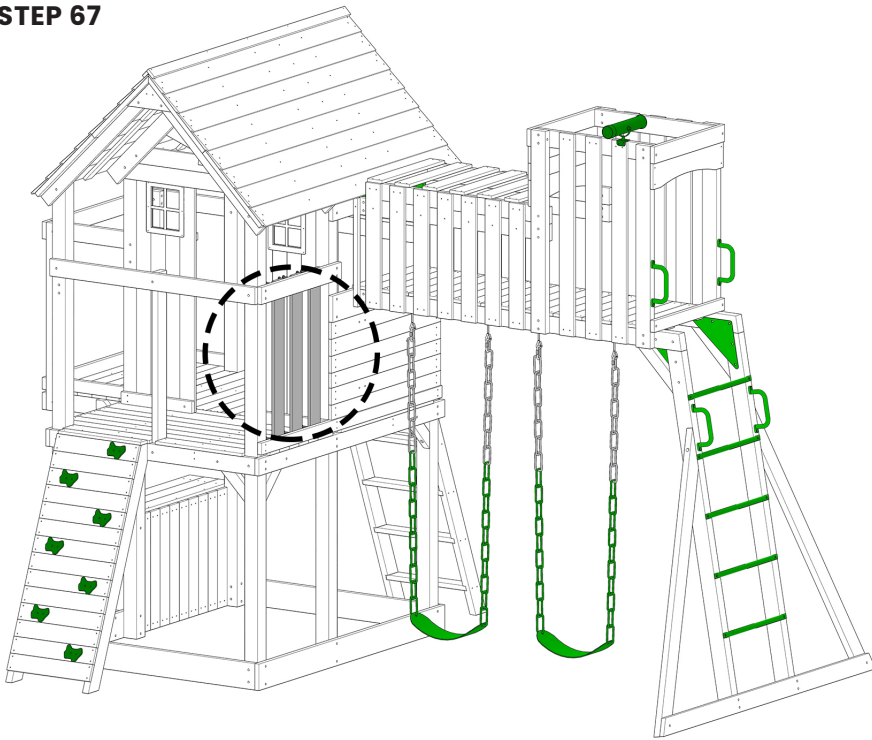

List	
Part NO.	Qty
H14	3
SW35	12

STEP 68

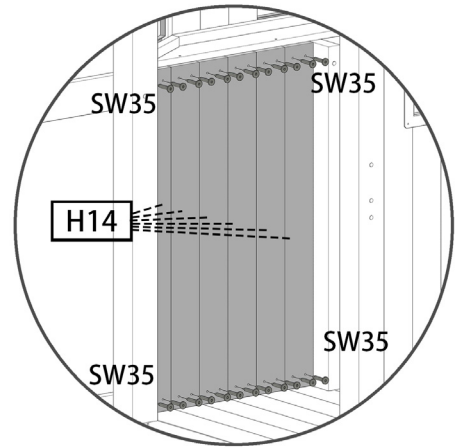
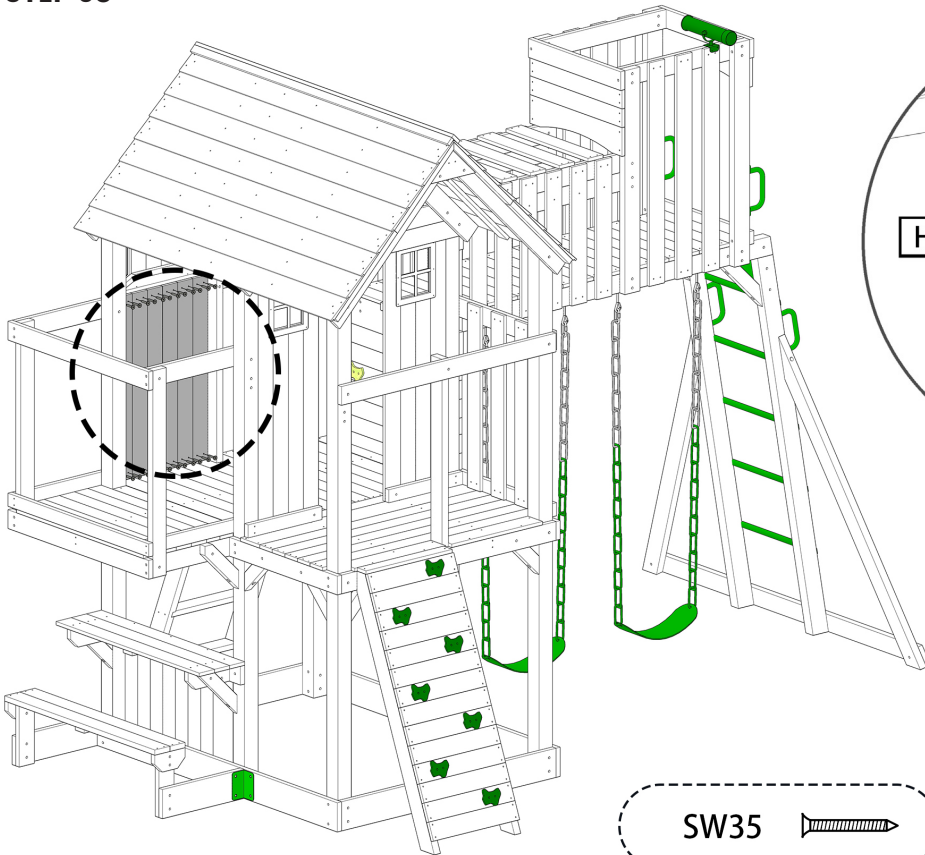

List	
Part NO.	Qty
H14	6
SW35	24

STEP 69

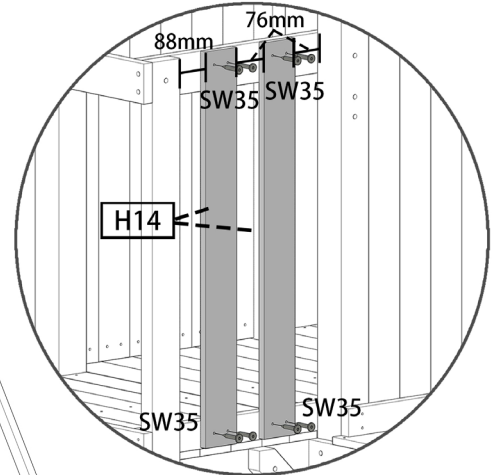
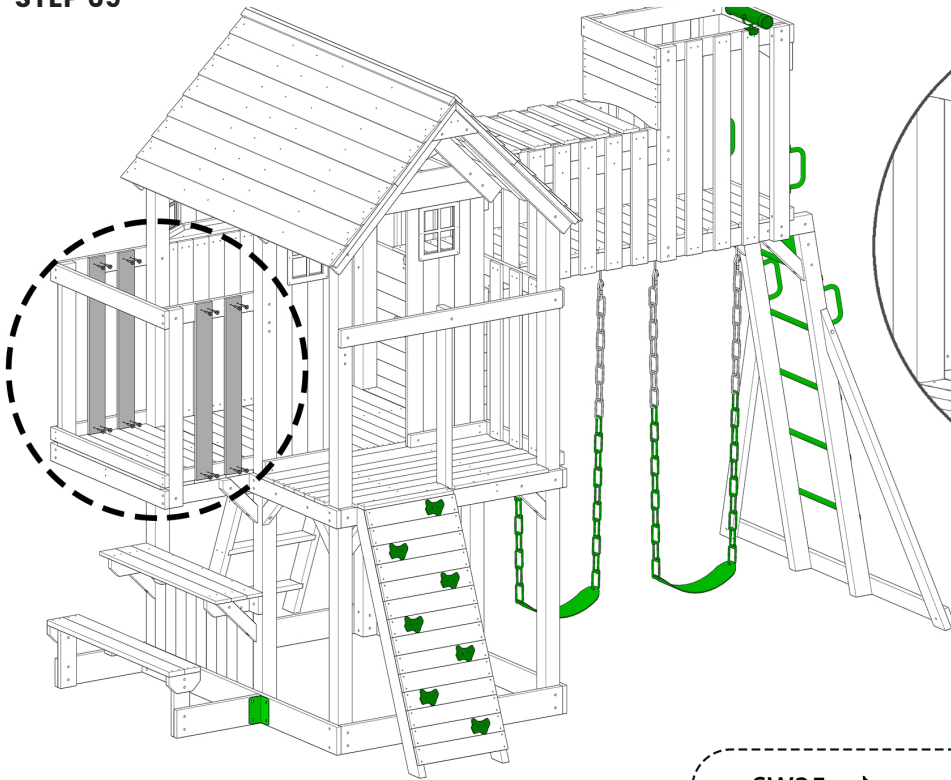

X2



List	
Part NO.	Qty
H14	4
SW35	16

STEP 70

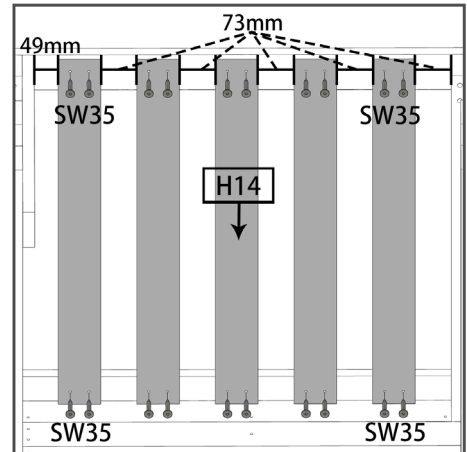
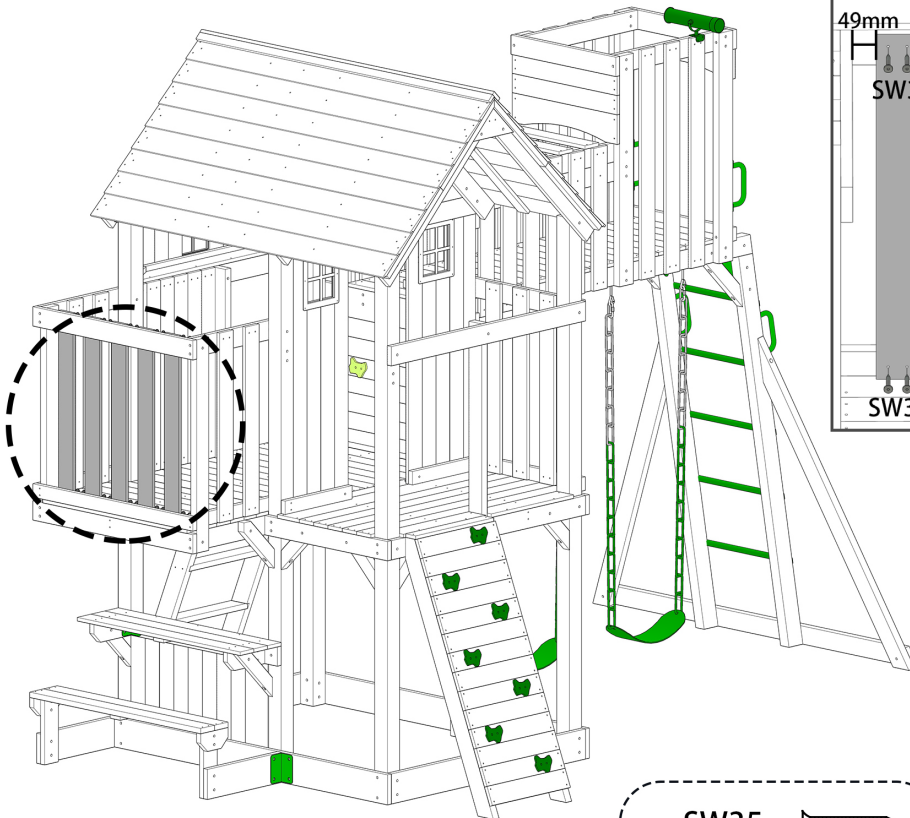

List	
Part NO.	Qty
H14	5
SW35	20

STEP 71

152003 X2

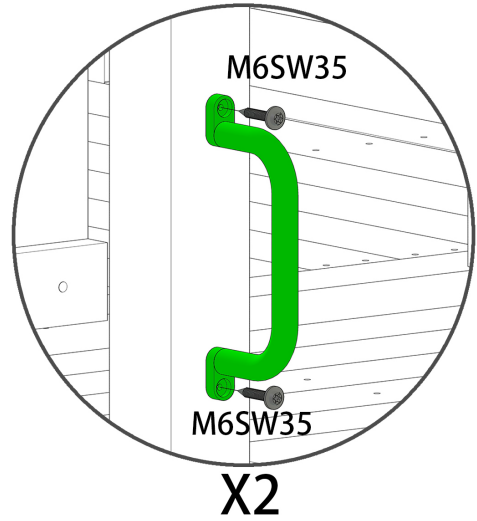
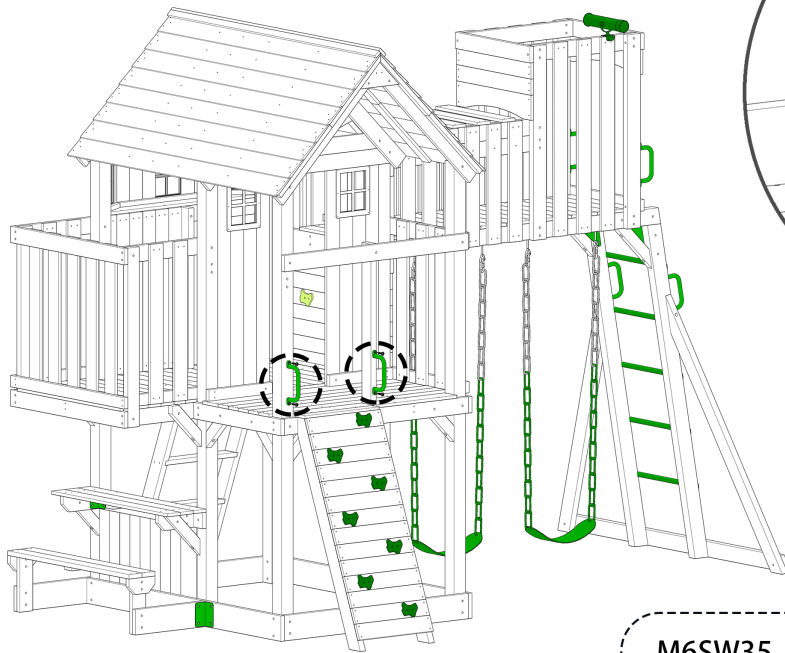

List	
Part NO.	Qty
M6SW35	4
152003	2

STEP 72

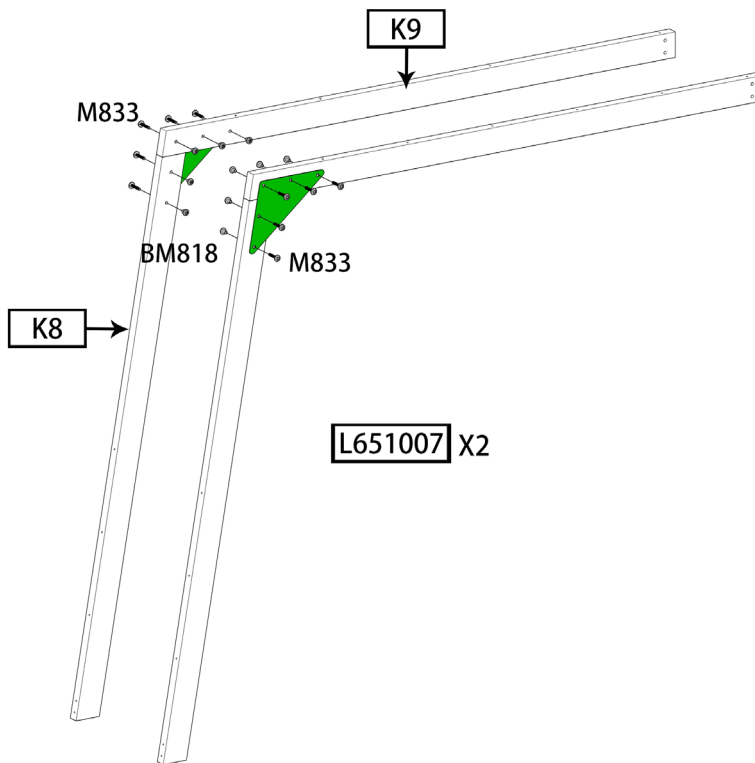

List	
Part NO.	Qty
K8	2
K9	2
M833	10
BM818	10
L651007	2

STEP 73

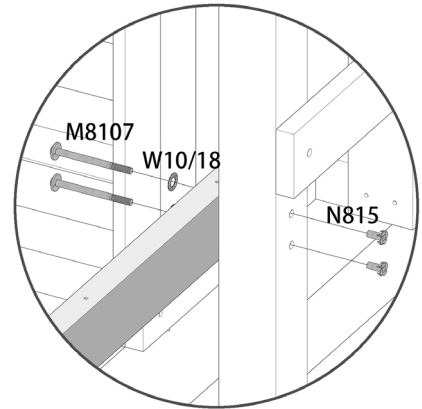
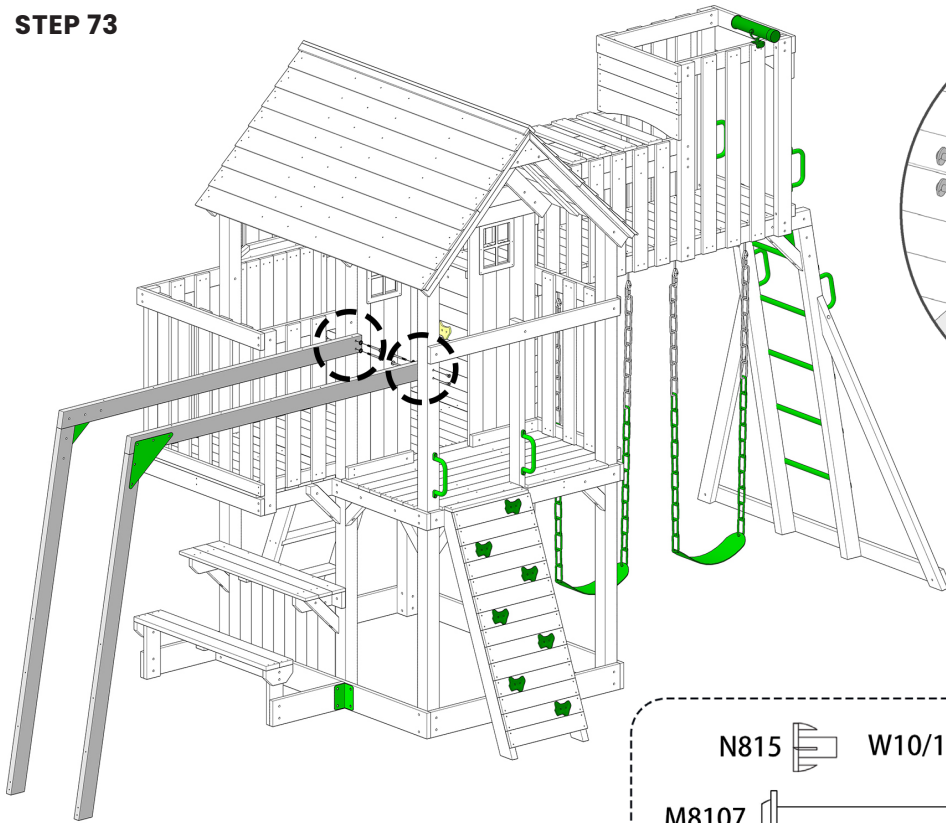

X2

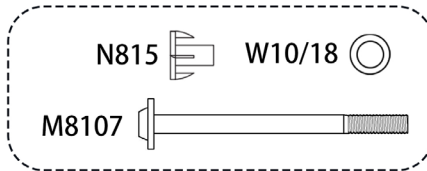

List	
Part NO.	Qty
M8107	4
W10/18	4
N815	4

STEP 74

L651006 X3

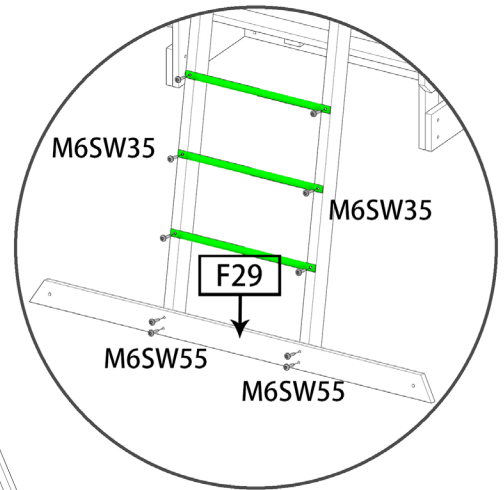
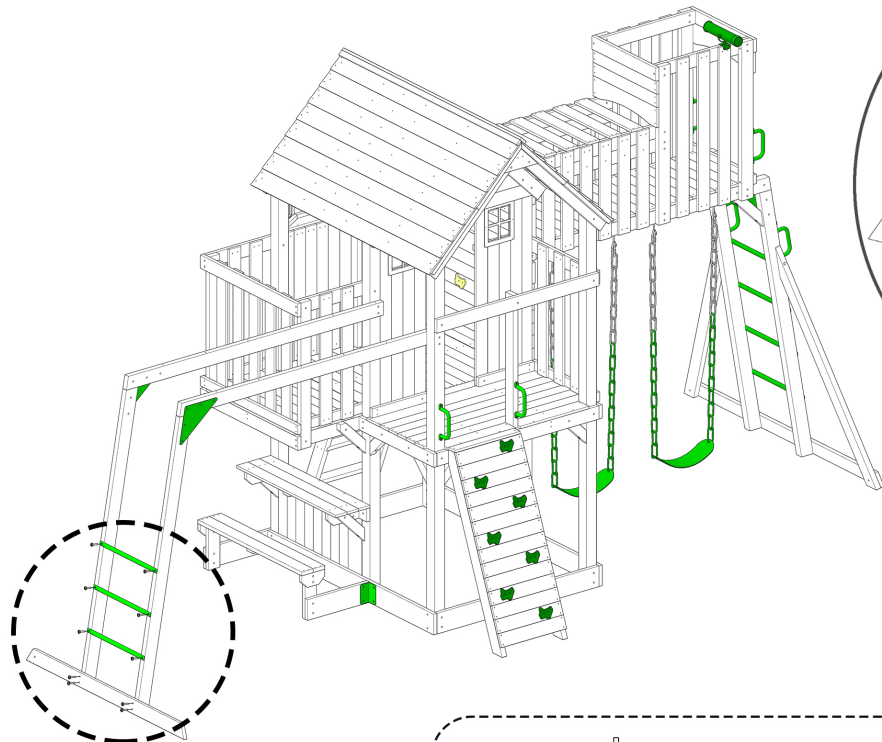

List	
Part NO.	Qty
M6SW35	6
M6SW55	4
L651006	3
F29	1

STEP 75

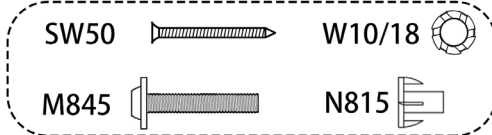
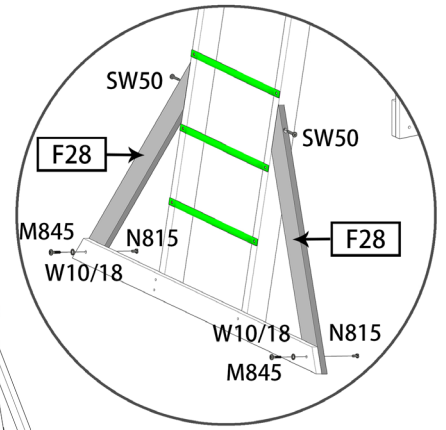
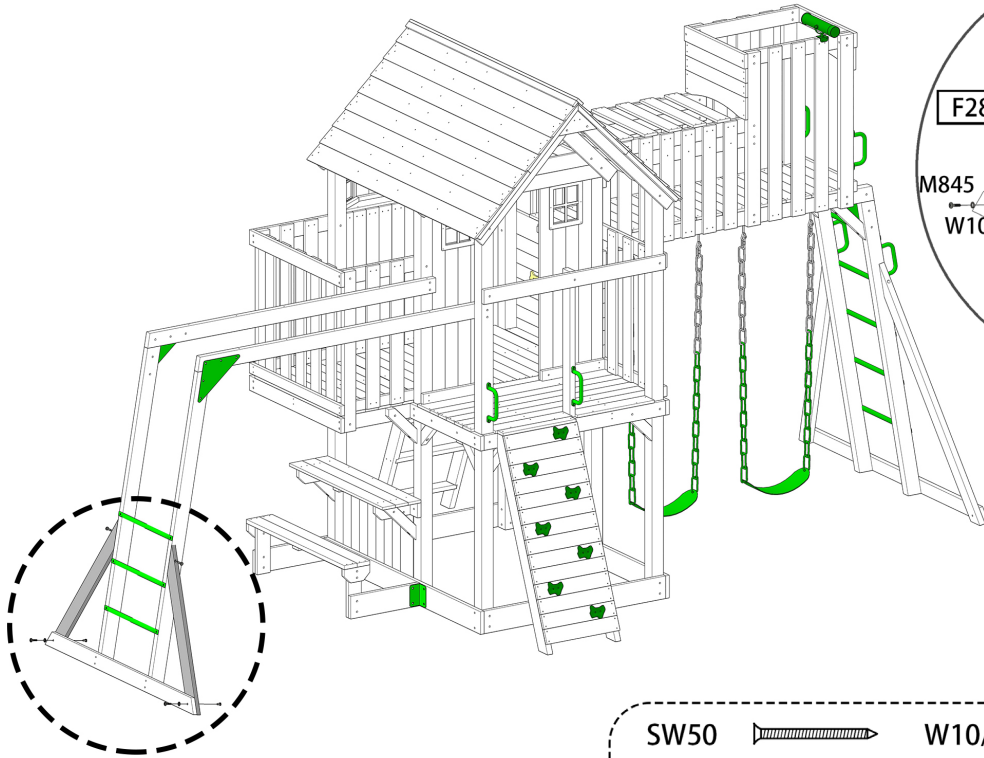

List	
Part NO.	Qty
F28	2
M845	2
W10/18	2
N815	2
SW50	2

STEP 76

L651006 X5

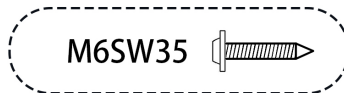
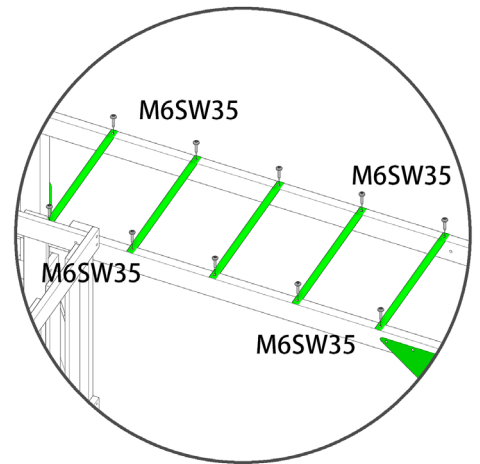
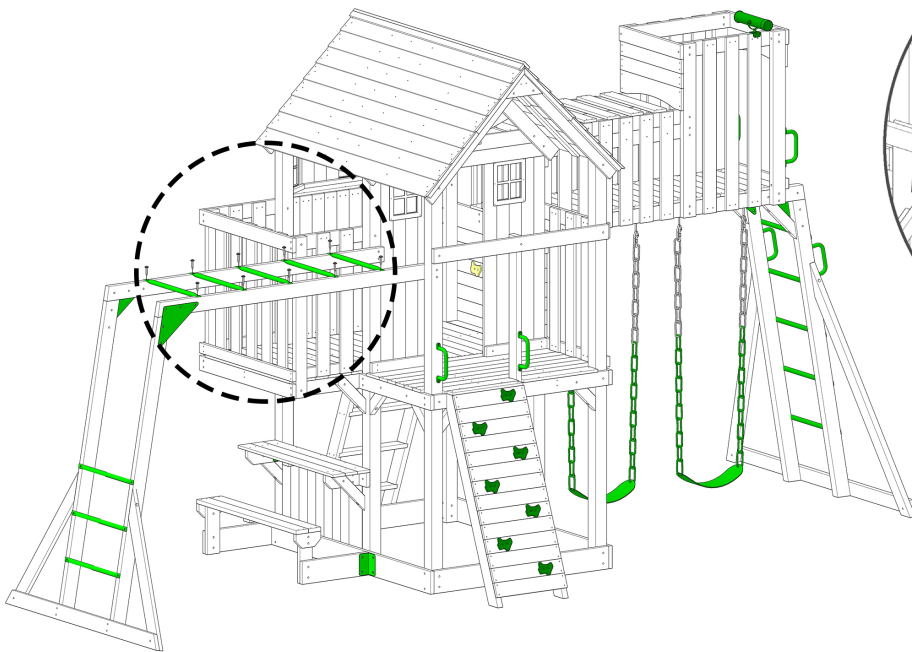

List	
Part NO.	Qty
M6SW35	10
L651006	5

STEP 77

152003 X2

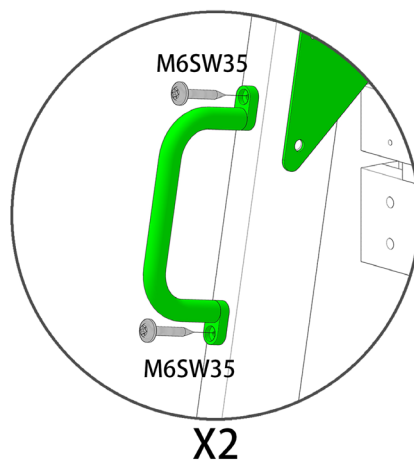
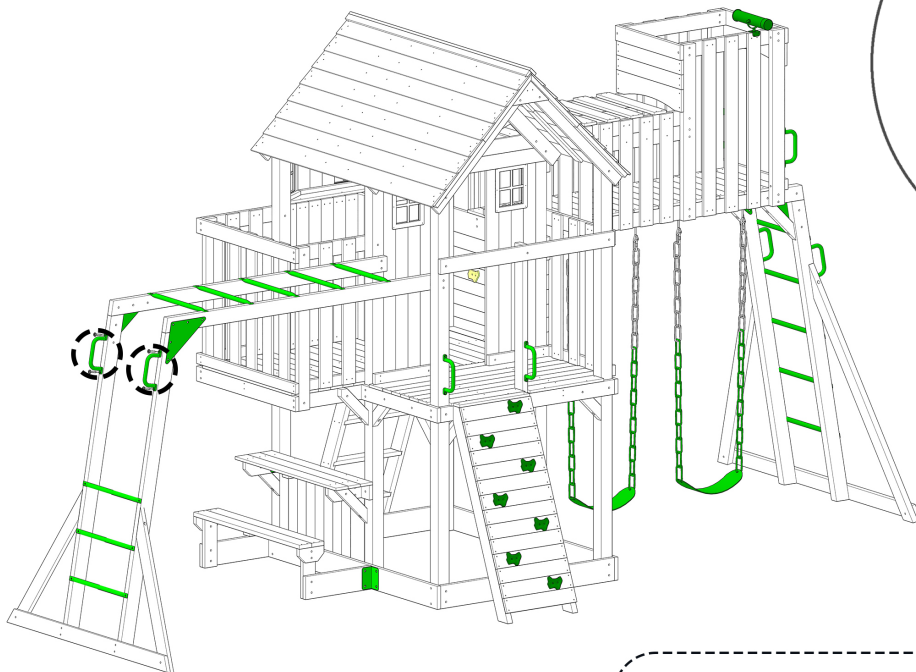

List	
Part NO.	Qty
M6SW35	4
152003	2

STEP 78

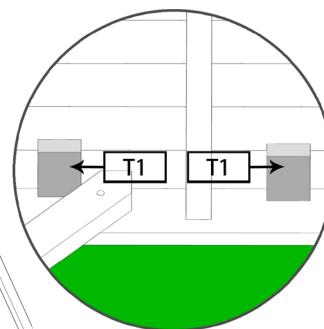
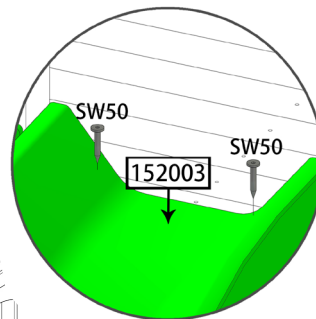
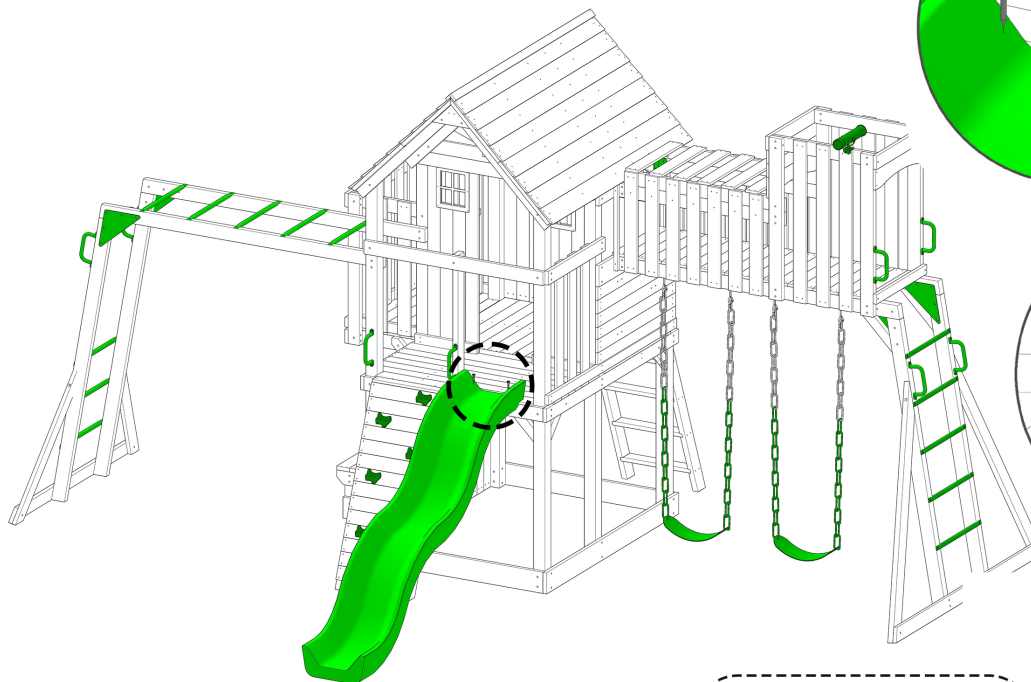

List	
Part NO.	Qty
T1	2
SW50	2
L650001	1

STEP 79

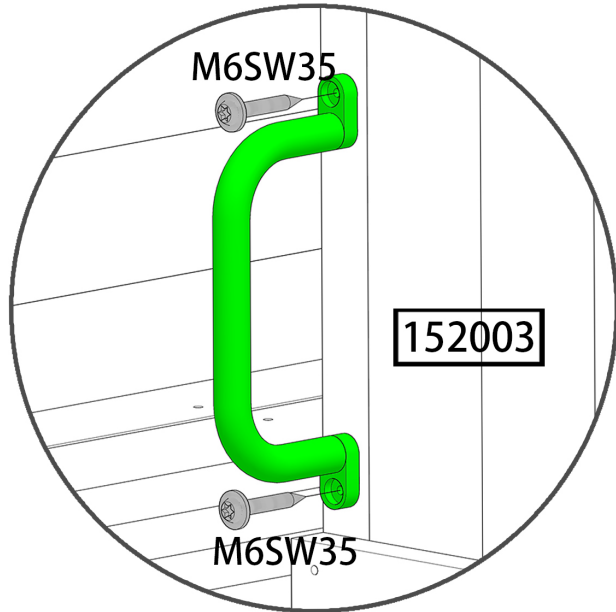
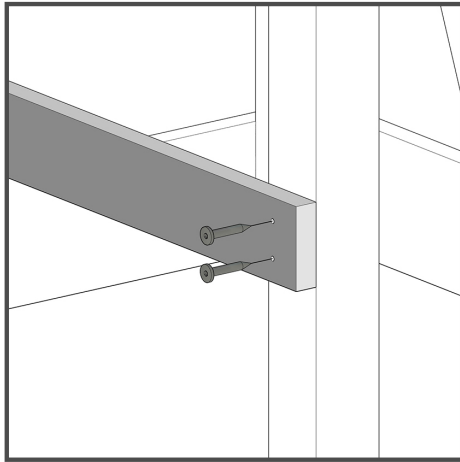

X2

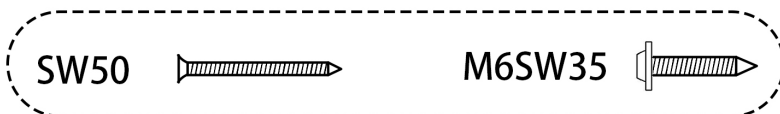
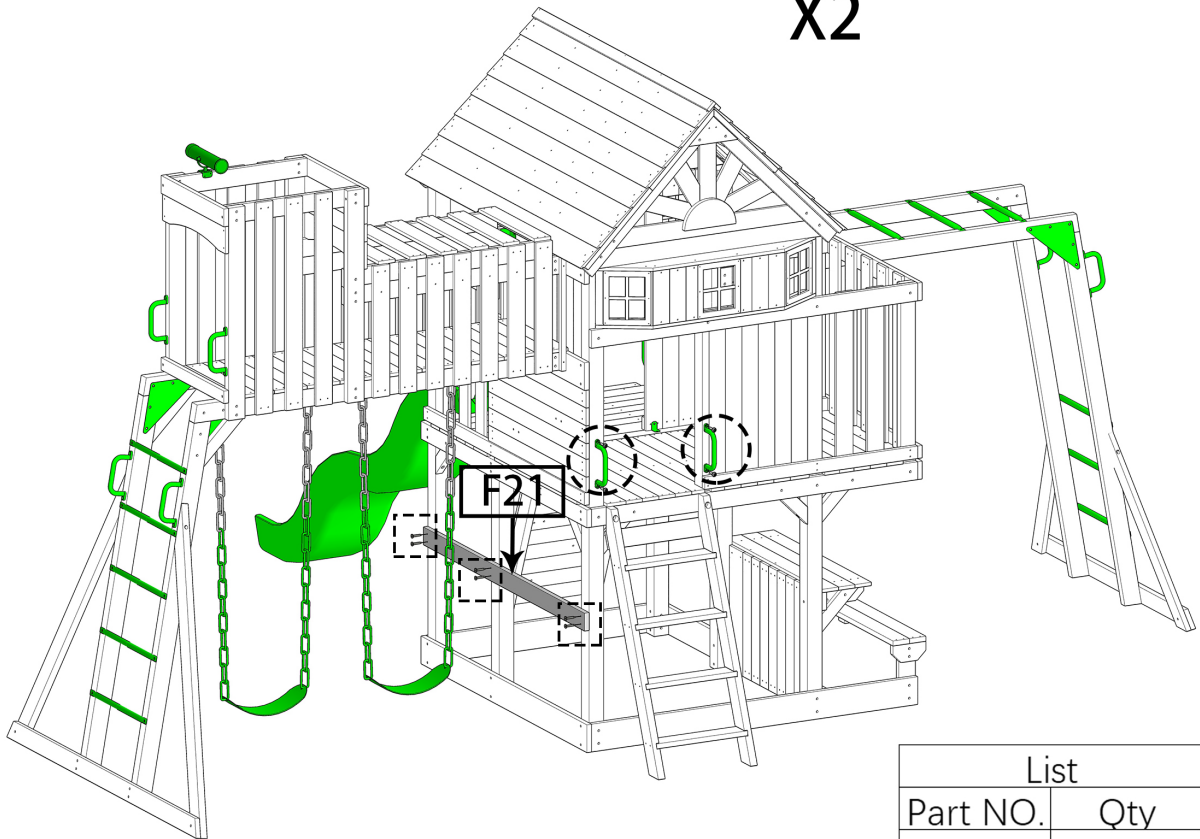

List	
Part NO.	Qty
M6SW35	4
152003	2
F21	1
SW50	6

STEP 80

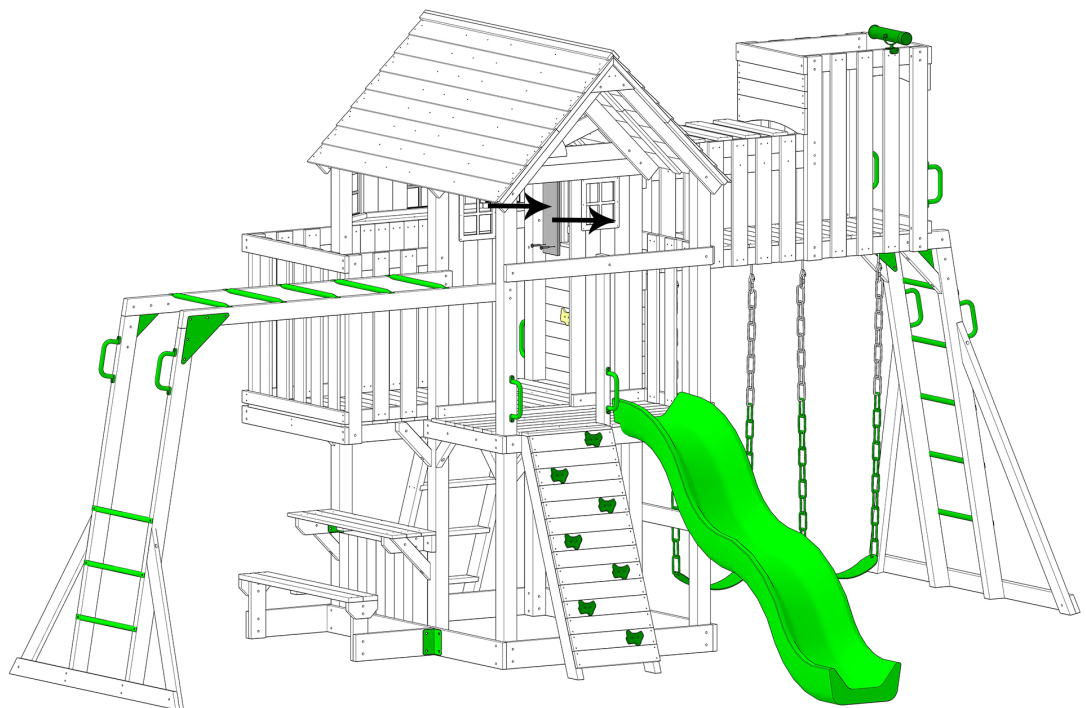
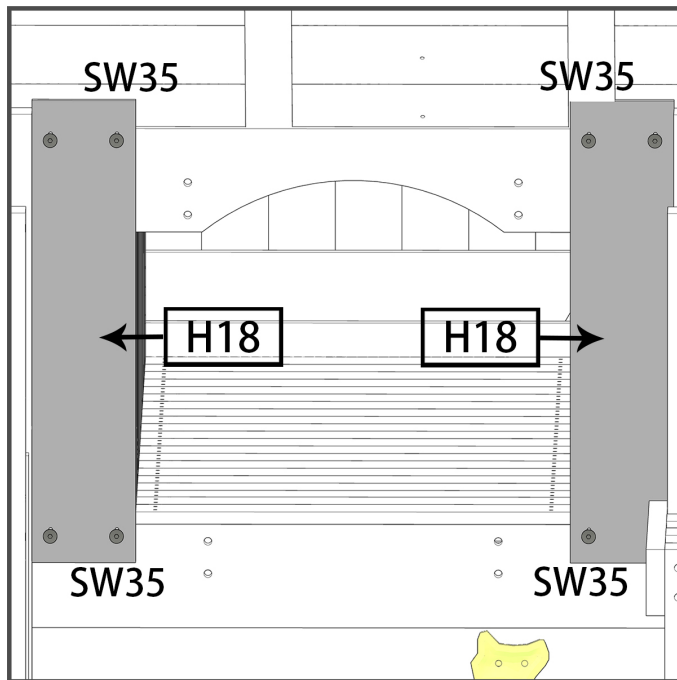

List	
Part NO.	Qty
H18	2
SW35	8

STEP 81

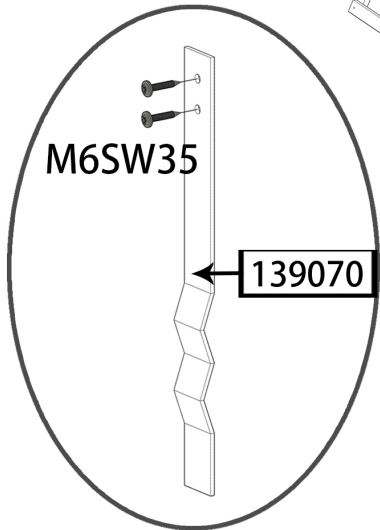
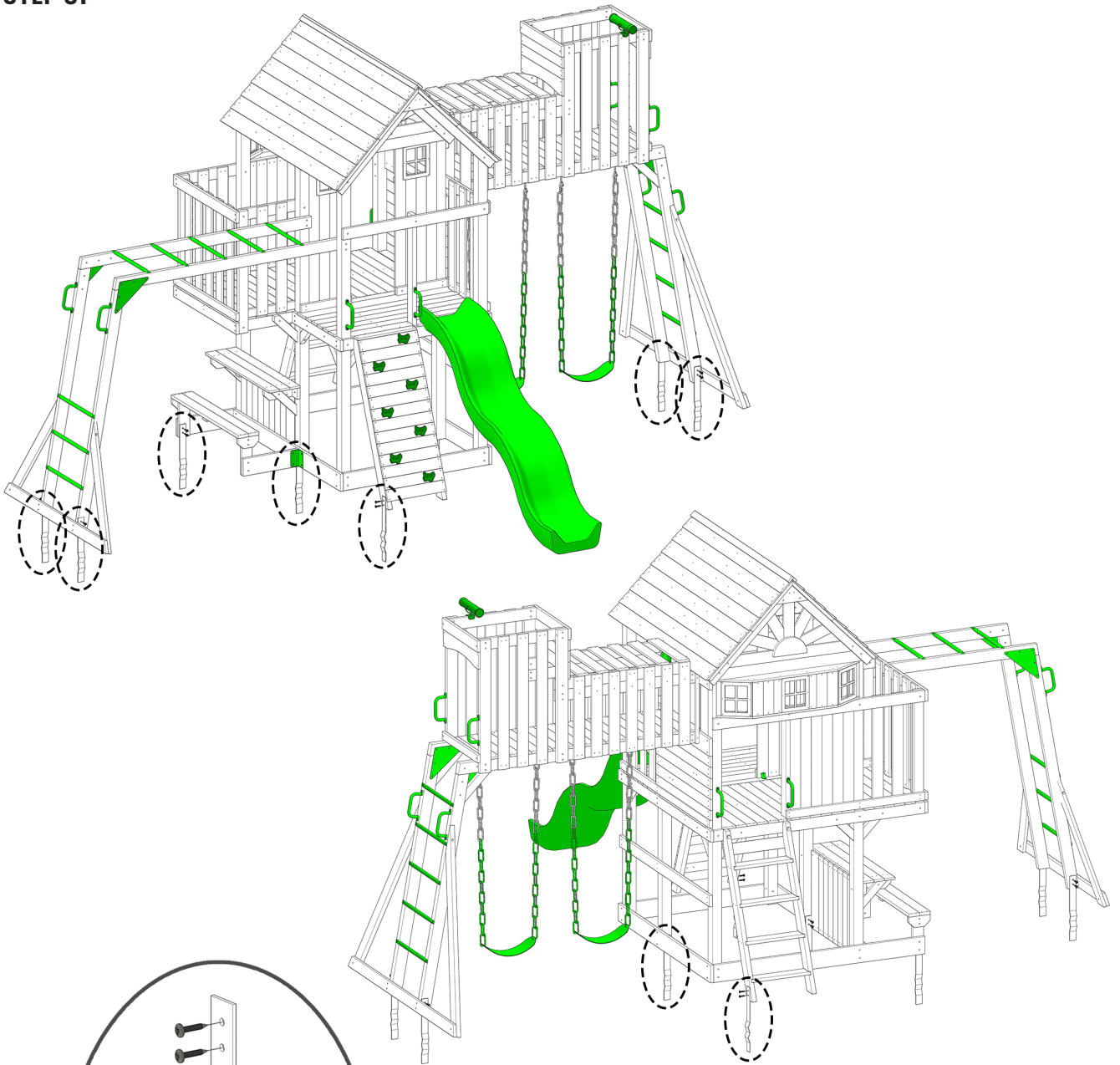

X9



List	
Part NO.	Qty
M6SW35	18
139070	9

IV. MAINTENANCE



WARNING: Please keep for future reference.

We recommend regular maintenance to be conducted at the beginning of each season as well as at regular intervals during the usage session for your play equipment to ensure all main parts/fixings are tightly secured, well-oiled and intact to avoid failure, injury or hazards.

GENERAL ADVICE

It is of particular importance that this is followed at the beginning of each season as well as at regular intervals during the usage season.

- Check the accessories monthly as well as the play equipment's structure to prevent falling risks.
- Check and retighten screws, bolts, and all other hardware elements as necessary.
 - a. Do not over tighten to avoid damaging the thread or cracking the surrounding wood.
- Check all coverings and bolts for sharp edges and replace when required.
- Lubricate all moving metallic parts.
- When signs of oxidation and / or rust appear on various metallic parts of your equipment, sand rusted areas and tubular members and repaint using a non-lead-based paint when required.
- Where applicable: check swing seats, chains, ropes, and other means of attachment for evidence of deterioration.
- Replace when required in accordance with the owner's manual.

If your play structure is disassembled, be sure to clearly mark any attached metal plates to prevent accidents. Check all bolt covers and sharp edges and replace them if necessary.

For longer accessory life, we suggest storing them during the winter.

V. WOOD ADVICE

Our products are manufactured from premium timber. Great care is taken in selecting, machining, and treating the timber before it is sold to you.

1. Inspect wood parts monthly. The grain of the wood sometimes will lift in dry periods causing splinters to appear. Light sanding may be necessary to maintain a safe environment. Treating your Product with protection (sealant) after sanding will help prevent severe checking/splitting and other weather damage.
2. The wood is treated via high temperature drying, degreasing and is stained against wood rot and insect damage (Termites not included). This is not a permanent treatment as weather conditions can wear it down. We recommend once or twice a year, depending on your climate conditions, you must apply some type of protection (sealant) to the wood of your unit. Prior to the application of sealant, lightly sand any "rough" spots on your set. **Please note this is a requirement of your warranty.**

Bear in mind that timber is a natural product and may experience changes throughout the course of its life. It may:

- Develop openings/checks (gaps, slits, apertures, cracks) along the line of the grain.
- Fade as the timber reacts with sunlight.

All woods are hygroscopic, that is, it will absorb or discharge moisture to attain equilibrium with the surrounding atmosphere. Timber openings/checks occur due to the moisture content between internal and outer surfaces of the timber. No two pieces of wood are exactly alike. Each piece has its own characteristics and personality and reacts differently to climate changes. When any wood products are exposed to the elements, it develops 'wood checks'. A check is the radial separation of the wood fibres running with the grain of the wood. These are caused by the varying temperature and moisture conditions. A check does not affect the strength or durability of the wood or structural integrity of the play set.

WHEN SHOULD WOOD CRACKS BE A CONCERN?

Most of the wood splits will never become large enough to affect the reliability and strength of our products, however, there can be rare cases where splits can occur. This happens when a crack develops past the halfway point from the timber, splitting it into two separate pieces.

Feel free to contact us with detailed pictures of your product so we can assess and ensure that your playground remains safe.

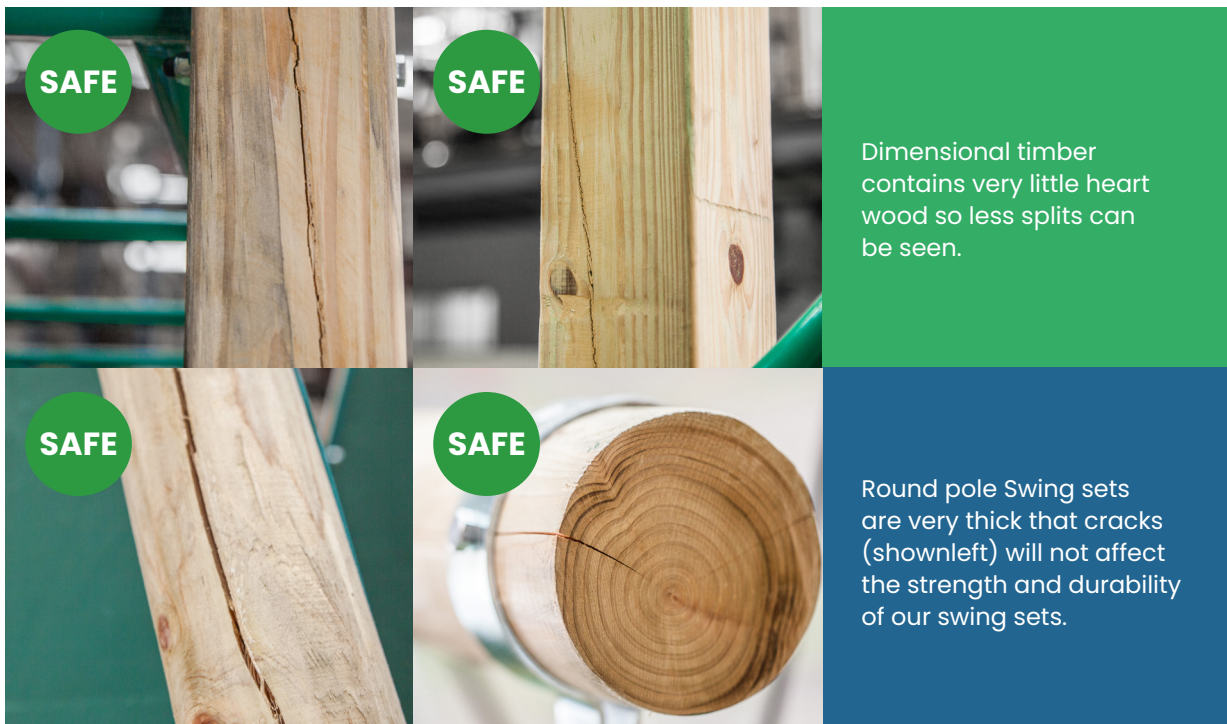

3. Mould and Mildew

Protecting against mould and mildew on your outdoor equipment is an important step in maintaining your backyard. Mould may develop for several reasons, such as certain weather conditions, improper drainage or infrequent usage. Here we'll share our tips for keeping your outdoor areas free of mould and mildew so that you can enjoy your backyard with peace of mind.

Once you spot mould on your equipment, it's important to start clearing it up straight away. The first step is to scrub it off with soap and water, until all the visible signs of mould are removed. It's important to remember however, that just because you can't see it anymore doesn't mean it's gone.

The next step is to kill off the remaining mould so that it doesn't grow back. Here are a few options, but keep in mind these should be used independently. Don't mix or combine these methods at the same time.

Mould Killer or Removal Spray

You can purchase off-the-shelf removal sprays that destroy mould either indoors or outdoors. For these products, make sure to follow the product instructions as well as wearing protective gloves to avoid contact with skin.

Bleach

A solution of bleach and water can also be highly effective in killing mould. For this method, mix the water and bleach on a 1 to 1 ratio, then use a sponge or brush to scrub the affected area. You can also use a higher concentration of bleach for spot treating. After bleach treatment, make sure to rinse off your equipment and allow to dry.

Vinegar

If mould is still lingers after applying bleach or a mould spray, vinegar will be an effective option for removing stubborn remnants. Vinegar will kill most types of mould and is best for nonporous materials like hard plastics or metal. The best method is to fill a spray-bottle with undiluted white vinegar of at least 5% acetic acid. Spray the affected area, then let sit for around an hour. Make sure to thoroughly rinse off afterwards.

For wooden equipment, you can add a coat of paint or stain after it has thoroughly dried.

Some people may find that mould keeps resurfacing after cleaning on certain areas. This can be due to a few reasons, such as poor sunlight. Areas without direct sun are more likely to become damp and take longer to dry off after rain. Consider removing obstacles or rearranging your equipment so that it receives more sunlight, which will also help to kill the mould once it develops.

For more information: www.lifespankids.com.au/natural-timber

VI. CLEANING

Do not use any abrasive cleansers for the cleaning. Use a soft, damp cloth to eliminate dirt and dust.

VII. WARRANTY

AUSTRALIAN CONSUMER LAW

Many of our products come with a guarantee or warranty from the manufacturer. In addition, they come with guarantees that cannot be excluded under the Australian Consumer Law. You are entitled to a replacement or refund for a major failure and compensation for any other reasonably foreseeable loss or damage.

You are entitled to have the goods repaired or replaced if the goods fail to be of acceptable quality and the failure does not amount to a major failure. Full details of your consumer rights may be found at www.consumerlaw.gov.au.

Please visit our website to view our full warranty terms and conditions:
www.lifespankids.com.au/Warranty-Policy-Kids

WARRANTY AND SUPPORT

Any claim against this warranty must be made through your original place of purchase. Proof of purchase is required before a warranty claim may be processed. If you have purchased this product from the Official Lifespan Kids website, please visit www.lifespankids.com.au/warranty-form

For support outside of warranty, if you wish to purchase replacement parts or request a repair or service, please visit www.lifespankids.com.au/warranty-form and fill in our Repair/Service Request Form or Parts Purchase Form.

