

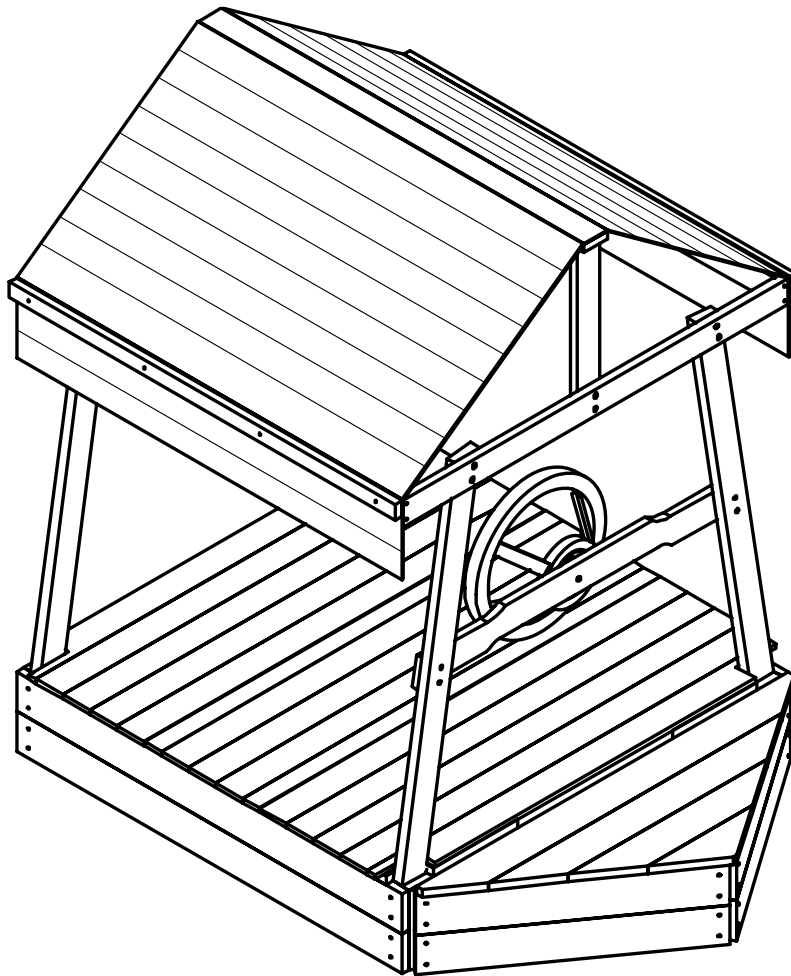

SC03

EXPLORER BOAT SANDPIT COVER

OWNER'S MANUAL



WARNING!

The disassembled product may contain small parts which pose a choking hazard to children under 3.

IMPORTANT:

This product may contain sharp points and small parts prior to assembly.

The owner's manual contains safety, assembly, use and maintenance instructions. This product must be assembled by an adult who has read and understood these instructions. Keep the packaging away from children and dispose of all packaging before use.

For the installer and your children's safety, it is important to fully read and understand the instructions and safety hazards before commencing the assembly of the product.

TABLE OF CONTENTS

1.	GENERAL SAFETY INSTRUCTIONS	3
1.1	DANGER FOR CHILDREN	3
1.2	RISK OF INJURIES	3
1.3	PRODUCT DAMAGE	3
1.4	ASSEMBLY ADVICE	3
2.	ASSEMBLY INSTRUCTIONS	5
3.	MAINTENANCE	6
4.	CLEANING	8
5.	WARRANTY	8

1 GENERAL SAFETY

This product is intended for indoor and outdoor, domestic use only.

1.1 DANGER FOR CHILDREN

- Children do not recognize potential dangers from this product. The product must be stored out of reach of children and pets.
- This product may only be used with adult supervision at all times.
- The packaging material is not suitable for children due to choking and suffocation hazards.

1.2 RISK OF INJURIES

- Do not use the product if it is damaged or defective. If it is damaged or defective, please contact a qualified technician.
- Check the product before each use. Defective parts must be changed immediately as they can impair the function and the safety of the product.

1.3 PRODUCT DAMAGE

- Do not make alterations to the product. Only use original spare parts. Qualified technicians should only carry out repairs – improper repairs can lead to danger for the user. Use this product only as described in this manual.
- Do not stand or place heavy object on the sandpit cover at any time.

1.4 ASSEMBLY ADVICE

- The assembly of the product must be done carefully and by an able-bodied adult. If in any doubt, ask a technically qualified person.
- Before you start with the assembly, read the instructions carefully.
- Remove all packaging materials and lay down all parts on an open space. This gives you an overview and simplifies the assembly procedure.
- Check with the parts list that all parts are available. Dispose of the packaging material when the assembly is completed.

- Beware that when using tools or doing technical work, there is always a risk of injuries. Assemble the product with care.
- Create a danger free environment; for example, do not let tools lay around the workspace. Store the packaging material in a way that cannot cause any danger.
- After installing the product according to the instruction manual, ensure all screws, bolts and nuts are correctly installed and tightened and that all joints are secure.
- Reasonable space must be kept between the product and possible sources of danger, such as other equipment swimming pools and fences.
- The product must be assembled correctly before use.
- Modifications made to the original product shall be carried out according to the instructions of the manufacturer.
- The product must always be used in a well-lit area.
- Do not place anything under the product.
- Use gloves during assembly and disassembly.
- Outdoor products should be equipped with a device that in strong wind conditions avoid displacement due to wind (e.g. steel bars in the ground or loads like sand bag or water bags).
- In certain areas during winter, snow buildup and the low temperatures can damage the product. It is recommended to remove snow buildup and to store the product indoor.
- We strongly recommend visual inspections every 3 months to insure the integrity of the entire product. Replace any parts as necessary.

2 ASSEMBLY INSTRUCTIONS

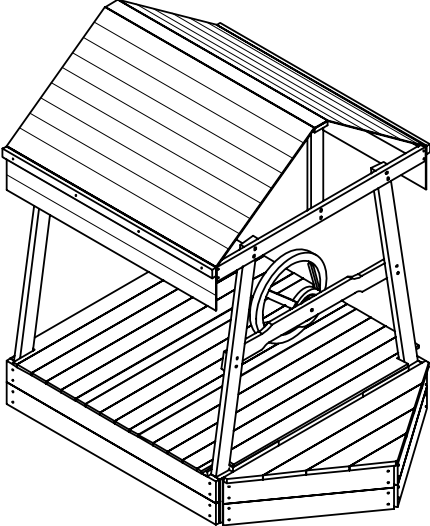
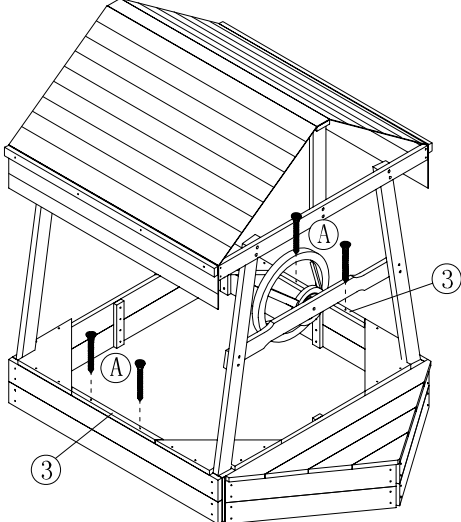
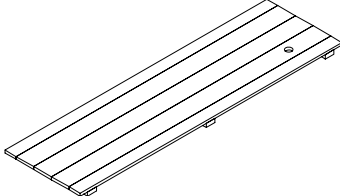
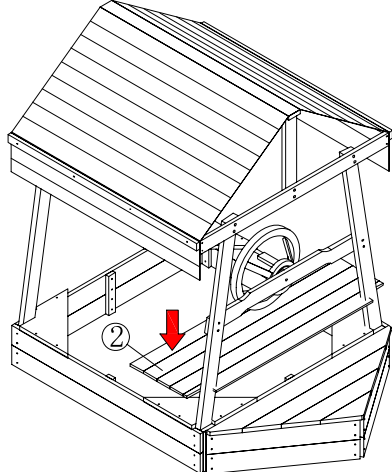
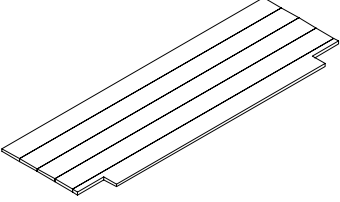
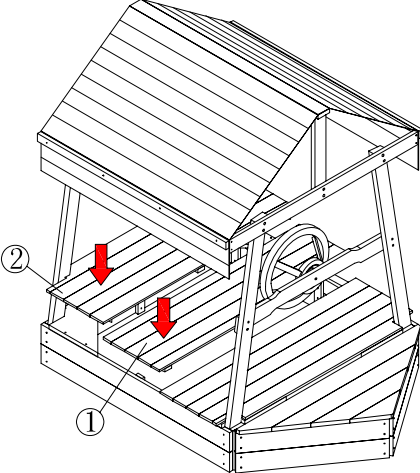
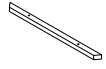
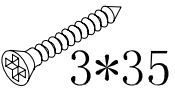
	<p>1</p> 
<p>1</p>  <p>1PC</p>	<p>2</p> 
<p>2</p>  <p>2PCS</p>	<p>3</p> 
<p>3</p>  <p>2PCS</p>	
<p>A</p>  <p>3*35</p> <p>2PCS</p>	

3 MAINTENANCE

WARNING: Please keep for future reference

We recommend regular maintenance to be conducted at the beginning of each season as well as at regular intervals during the usage session for your play equipment to ensure all main parts/fixings are tightly secured, well-oiled and intact to avoid injury or hazards.

It is of particular importance that this is followed at the beginning of each season as well as at regular intervals during the usage season

Check the accessories monthly as well as the play equipment's structure in order to prevent falling risks.

Check and retighten screws, bolts and all other hardware elements as necessary, lubricate all moving metallic parts. For longer accessory life, we suggest storing them during the winter.

When signs of oxidation and / or rust appear on various metallic parts of your equipment, sand rusted areas and tubular members and repaint using a non-lead based paint when required. Replace any parts as necessary.

If your play structure is disassembled, be sure to clearly mark any attached metal plates to prevent accidents. Check all bolt covers and sharp edges and replace them if necessary.

WOOD ADVICE

Our products are manufactured from premium timber. Great care is taken in selecting, machining and treating the timber before it is sold to you.

1. Inspect wood parts monthly. The grain of the wood sometimes will lift in dry periods causing splinters to appear. Light sanding may be necessary to maintain a safe environment. Treating your Product with protection (sealant) after sanding will help prevent severe checking/splitting and other weather damage.
2. We have applied a waterborne translucent stain to your unit. This is done for colour only. Once or twice a year, depending on your climate conditions, you must apply some type of protection (sealant) to the wood of your unit. Prior to the application of sealant, lightly sand any "rough" spots on your set. Please note this is a requirement of your warranty.

Bear in mind that timber is a natural product and may experience changes throughout the course of its life.

It may:

- Develop openings/checks (gaps, slits, apertures, cracks) along the line of the grain.
- Fade as the timber reacts with sunlight.

All woods are hygroscopic, that is, it will absorb or discharge moisture to attain equilibrium with the surrounding atmosphere. Timber openings/checks occur due to the moisture content between internal and outer surfaces of the timber. No two pieces of wood are exactly alike. Each piece has its own characteristics and personality and reacts differently to climate changes. When any wood products are exposed to the elements, it develops 'wood checks'. A check is the radial separation of the wood fibres running with the grain of the wood. These are caused by the varying temperature and moisture conditions. A check does not affect the strength or durability of the wood or structural integrity of the play set.

When should wood cracks be a concern?

Most of the wood splits will never become large enough to affect the reliability and strength of our products, however, there can be rare cases where splits can occur. This happens when a crack develops past the halfway point from the timber, splitting it into two separate pieces.

Feel free to contact us with detailed pictures of your product so we can assess and ensure that your playground remains safe.

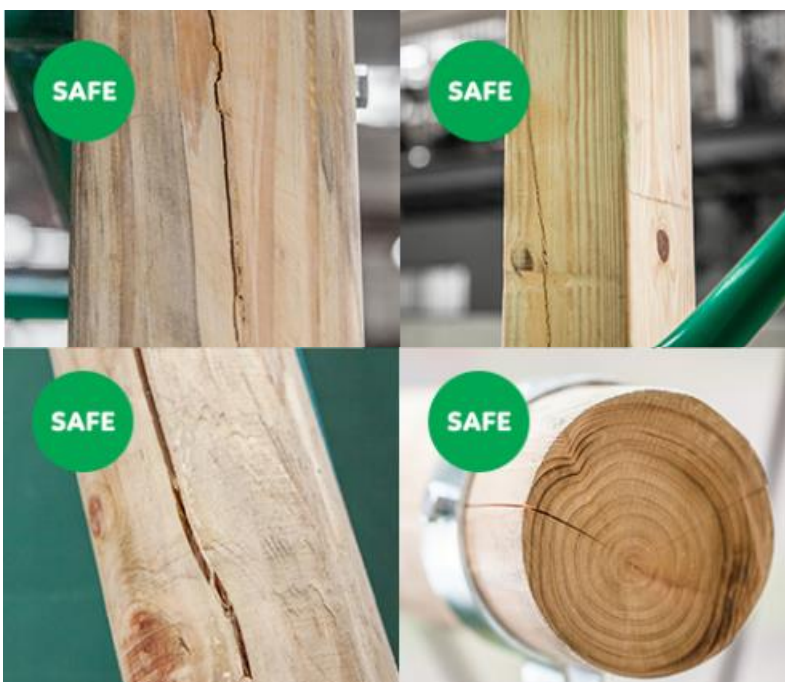

Dimensional timbers contain very little heart wood so less splits can be seen.

Round pole swing set are very thick so that cracks (shown left) will not affect the strength and durability of our swing sets.

For more information: <http://www.lifespankids.com.au/natural-timber>

4 CLEANING

Do not use any abrasive cleansers for the cleaning. Use a soft, damp cloth to eliminate dirt and dust.

5 WARRANTY

AUSTRALIAN CONSUMER LAW

Many of our products come with a guarantee or warranty from the manufacturer. In addition, they come with guarantees that cannot be excluded under the Australian Consumer law. You are entitled to a replacement or refund for a major failure and compensation for any other reasonably foreseeable loss or damage.

You are entitled to have the goods repaired or replaced if the goods fail to be of acceptable quality and the failure does not amount to a major failure. Full details of your consumer rights may be found at www.consumerlaw.gov.au

Please visit our website to view our full warranty terms and conditions:

<http://www.lifespankids.com.au/Warranty-Policy-Kids>

Please send all warranty and support inquiries through our ticketing system via the email address: support@lifespankids.com.au.