



SPRING COTTAGE PLAYHOUSE

Model # 1902312 | Owner's Manual & Assembly Instructions

MANUFACTURED BY:
Backyard Discovery
3305 Airport Drive
Pittsburg, KS 66762
800-856-4445
Basepoint Business Centre
Rivermead Drive
Westlea
Swindon
SN5 7EX



WARNING

Adult Assembly Required.
Not suitable for children under two years, due to sharp points and small parts. Only for domestic use.

The playhouse is intended for outdoor use.



INSTALLATION SERVICES AVAILABLE!*

Need a helping hand?

Let our team of professionals handle the installation for you!

GOCONFIGURE
888-888-5424

*Installation services are only available to U.S. customers.

average 2 person assembly time



assembly time may vary based on skill level

Before you begin

FOR QUICK & EASY ASSEMBLY
FIND 3D INSTRUCTIONS FOR THIS PRODUCT IN

BILT.

DOWNLOAD THE FREE APP



For the most up to date assembly manual, to register your set, or to order replacement parts please visit www.backyarddiscovery.com

SAVE THIS ASSEMBLY MANUAL FOR FUTURE REFERENCE IN THE EVENT THAT YOU NEED TO ORDER REPLACEMENT PARTS.

Para obtener instrucciones en español, visite www.backyarddiscovery.com



GOCONFIGURE
Putting it all together for you

INSTALLATION SERVICES AVAILABLE!*

Need a helping hand?

Let our team of professionals handle the installation for you!

GOCONFIGURE
888-888-5424

**Installation services are only available
to U.S. customers.*

With Go Configure, we bring you 18 years of experience right to your doorstep. We service a wide array of indoor and outdoor recreation products that most consumers don't have the time or ability to deliver & install themselves.

We do the heavy lifting, so you don't have to!

-
- 18+ Years of Experience Servicing Big Box Retailers and Direct Consumers
 - Highly Skilled, Specialized, Courteous, Professional Service Technicians
 - Over 140,000 Installations Annually
 - White Glove Service

- Satisfaction Guarantee
 - Flexible Appointments, including weekends
 - Coverage across the nation
- Visit www.goconfigure.com for more info!**

**Installation services are only available to U.S. customers.*



The store where you made your purchase does not stock parts for this item. If you have assembly questions or you are missing or have damaged parts, please call

1-800-856-4445

you can also visit www.backyarddiscovery.com
or e-mail customerservice@backyarddiscovery.com

Please have the following information ready when you make your call:

- Model Number of the product located on the front of the assembly manual
 - The item description and number from the parts list from the manual that was included in your box
-
- Read entire assembly manual, paying special attention to the important tips and safety information.
 - To ensure there are no missing pieces do a complete inventory by first separating and identifying all parts.
 - Make sure to check packing material for small parts that may have fallen out during shipment.
 - Structures are not intended for public use. The Company does not warranty any of its residential structures subjected to commercial use.
 - This manual contains helpful information concerning assembly preparation, installation procedure and required maintenance.
 - Always keep safety in mind as your structure is being built.
 - Keep these instructions for future reference.



Please read entire booklet completely before beginning the assembly process

Please retain these instructions and your receipt for future reference. Keep them in a safe place where you can refer to them as needed. In order to provide you with the most efficient service, it is required that you provide us with the part numbers when ordering parts.

For Your Records:

Please take time and fill out the information below. This information will be needed for warranty issues.

Where Purchased: _____
 Date of Purchase: _____
 Installation Date: _____
 Installed by: _____
 Tracking Number: _____

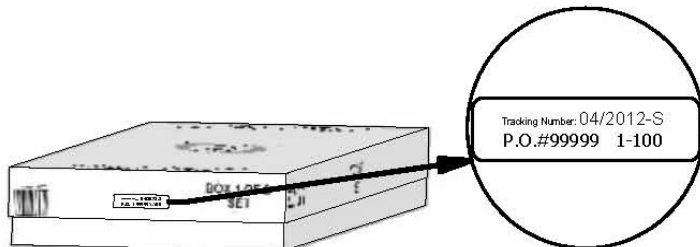

Tracking Number Reference Label

Tracking ID number on the carton and on the bottom of the vertical ID plate are included for tracking purposes associated with warranty claims.

This Limited Warranty by Backyard Discovery applies to products manufactured under the Backyard Discovery brand or its other brands including but not limited to Backyard Botanical, Adventure Playsets, and Leisure Time Products.

Backyard Discovery warrants that this product is free from defect in materials and workmanship for a period of one (1) year from the original date of purchase. This one (1) year warranty covers all parts including wood, hardware, and accessories. All wood carries a five (5) year pro-rated warranty against rot and decay. Refer to the schedule below for charges associated with replacement of parts under this Limited Warranty. In addition, Backyard Discovery will replace any parts within the first 30 days from date of purchase found to be missing from or damaged in the original packaging.

This warranty applies to the original owner and registrant and is non-transferable. Regular maintenance is required to assure maximum life and performance of this product. Failure by the owner to maintain the product according to the maintenance requirements may void this warranty. Maintenance guidelines are provided in the Owner's Manual.

This Limited Warranty does not cover:

- Installation
- Labor for any inspection
- Labor for replacement of any defective item(s)
- Incidental or consequential damages
- Cosmetic defects which do not affect performance or integrity of a part or the entire product
- Vandalism, improper use, failure due to loading or use beyond the capacities stated in the applicable Assembly Manual.
- Acts of nature including but not limited to wind, storms, hail, floods, excessive water exposure
- Improper installation including but not limited to installation on uneven, unlevel, or soft ground
- Minor twisting, warping, checking, or any other natural occurring properties of wood that do not affect performance or integrity

Backyard Discovery products have been designed for safety and quality. Any modifications made to the original product could damage the structural integrity of the unit leading to failure and possible injury. Modification voids any and all warranties and Backyard Discovery assumes no liability for any modified products or consequences resulting from failure of a modified product.

This product is warranted for RESIDENTIAL USE ONLY. Under no circumstance should a Backyard Discovery product be used in public settings. Such use may lead to product failure and potential injury. Any and all public use will void this warranty. Backyard Discovery disclaims all other representations and warranties of any kind, express or implied.

Pro Rated Part Replacement Schedule

Product Age

All Parts

0-30 days from date of purchase
 31 days to 1 year

Wood Rot and Decay Only

1 year
 2 year
 3 year
 4 year
 5 year
 Over 5 years

Customer Pays

\$0 and free shipping
 \$0 + S&H

\$0 and free shipping
 20% + S&H
 40% + S&H
 60% + S&H
 80% + S&H
 100% + S&H



NOTE:

Your Children's Safety Is Our #1 Concern!

Observe the following statements and warnings to reduce the likelihood of serious or fatal injury. Please review these safety rules regularly with your children.



WARNING: BURN HAZARD

- Pay special attention to plastic and metal surfaces as they may be hot enough to cause burns.
- Always check the temperature of the product before letting your children play on it.
- Remember that the product may cause burns if left in direct sunlight.
- Always be aware of the sun and weather conditions, and do not assume that the equipment is safe because the air temperature is not very high.

- Equipment is recommended for use by children 2 to 10 years of age.
- On-site adult supervision is required.
- Instruct children not to climb when the equipment is wet.
- Instruct children to never crawl on top of a play house roof.
- The parents should have the children dress appropriately with well-fitting shoes. Loose clothing such as scarves and ponchos should not be worn. Always take off, tie up or tuck in cords and drawstrings on children's clothing. These things can get caught on playground equipment and strangle a child.
- Instruct children not to attach items to the equipment that are not specifically designed for use with that equipment (such as ropes, clothesline, pet leashes, etc.).
- Instruct children to remove their bike or other sports helmet before playing on the playground equipment.
- Instruct children to **always** go down slides feet first. Never slide head first.
- Instruct children to **look** before they slide to make sure no one is at the bottom.
- Do **not** allow children to run up a slide, as this increases their chances of falling.



Positioning Your Playhouse

- The playhouse is designed to be installed on a level surface by an Adult with an Adult helper. Place in a flat area of your yard to minimize ground preparation.
- Choose a level location for the equipment. This can reduce the likelihood of the playhouse tipping over and loose-fill surfacing material washing away during heavy rains.
- Place the equipment not less than 6 ft (1.8 m) from any structure or obstruction such as a fence, garage, house, overhanging branches, laundry lines, or electrical wires.
- It is a good idea to place your playhouse in an area that is convenient for adults to watch children at play.
- Create a site free of obstacles that could cause injuries – such as low overhanging tree branches, overhead wires, tree stumps and/or roots, large rocks, bricks and concrete. We have additional suggestions in the Suggested Playground Surfacing Section.
- Do not build your playhouse on top of surfacing material.

Suggested Playground Surfacing

- Do not install home playground equipment over concrete, asphalt, packed earth, grass, carpet, or any other hard surface. A fall onto a hard surface can result in serious injury to the equipment user.
- Do not install loose fill surfacing over hard surfaces such as concrete or asphalt.
- Shredded bark mulch, wood chips, fine sand and fine gravel, are added as shock absorbing materials after assembly. If used properly these materials can absorb some of the impact of a child's fall.
- All surface material should extend a minimum of 6 feet in all directions around the play area.
- Do not apply playground surfacing until after the unit is completely constructed. Play house should not be built on top of surfacing.
- Use containment, such as digging out around the perimeter and/or lining the perimeter with landscape edging.
- Installations of rubber tiles or poured-in-place surfaces (other than loose-fill materials) generally require a professional and are not "do-it-yourself" projects.
- Shall use Playground Surfacing Materials (other than loose-fill material) which comply with the safety standard ASTM F1292 Standard Specification of Impact Attenuation of Surfacing Materials within the Use Zone of Playground Equipment.

The following chart explains the fall height in feet from which a life threatening head injury would not be expected

Critical Heights in feet (m) of Tested Materials

Material	Uncompressed Depth			Compressed Depth to 9" (228mm)
	6" (152mm)	9" (228mm)	12" (304mm)	
Wood Chips	7' (2.13m)	10-12' (3.0-3.6m)	11' (3.35m)	10' (3.05m)
Double-Shredded Bark Mulch	6' (1.83m)	10-12' (3.0-3.6m)	11' (3.35m)	7' (2.13m)
Engineered Wood Fibers	6' (1.83m)	7' (2.13m)	>12' (3.66m)	6' (1.83m)
Fine Sand	5' (1.52m)	5' (1.52m)	9' (2.74m)	5' (1.52m)
Coarse Sand	5' (1.52m)	5' (1.52m)	6' (1.83m)	4' (1.22m)
Fine Gravel	5' (1.52m)	7' (2.13m)	10' (3.05m)	6' (1.83m)
Medium Gravel	5' (1.52m)	5' (1.52m)	6' (1.83m)	5' (1.52m)
Shredded Tires*	10-12' (3.0-3.6m)	N/A	N/A	N/A

*This data is from tests conducted by independent testing laboratories on a 6-inch depth of uncompressed shredded tire samples produced by four manufacturers. The tests reported critical heights, which varied from 10 feet to greater than 12 feet. It is recommended that persons seeking to install shredded tires as a protective surface request test data from the supplier showing the critical height of the material when it was tested in accordance with ASTM F1292.



APPENDIX A

The following information is from the United States Consumer Product Safety Commission's Information Sheet for playground surfacing material; also see the following website for additional information: www.cpsc.gov

X3. SECTION 4 OF THE CONSUMER PRODUCT SAFETY COMMISSION'S OUTDOOR HOME PLAYGROUND SAFETY HANDBOOK⁹

X3.1 Select Protective Surfacing—One of the most important things you can do to reduce the likelihood of serious head injuries is to install shock-absorbing protective surfacing under and around your play equipment. The protective surfacing should be applied to a depth that is suitable for the equipment height in accordance with ASTM Specification F 1292. There are different types of surfacing to choose from; whichever product you select, follow these guidelines:

X3.1.1 Loose-Fill Materials:

X3.1.1.1 Maintain a minimum depth of 9 inches of loose-fill materials such as wood mulch/chips, engineered wood fiber (EWF), or shredded/recycled rubber mulch for equipment up to 8 feet high; and 9 inches of sand or pea gravel for equipment up to 5 feet high. NOTE: An initial fill level of 12 inches will compress to about a 9-inch depth of surfacing overtime. The surfacing will also compact, displace, and settle, and should be periodically refilled to maintain at least a 9-inch depth.

X3.1.2 Use a minimum of 6 inches of protective surfacing for play equipment less than 4 feet in height. If maintained properly, this should be adequate. (At depths less than 6 inches, the protective material is too easily displaced or compacted.)

NOTE: Do not install home playground equipment over concrete, asphalt, or any other hard surface. A fall onto a hard surface can result in serious injury to the equipment user. Grass and dirt are not considered protective surfacing because wear and environmental factors can reduce their shock absorbing effectiveness. Carpeting and thin mats are generally not adequate protective surfacing. Ground level equipment such as a sandbox, activity wall, playhouse or other equipment that has no elevated play surface – does not need any protective surfacing.

X3.1.3 Use containment, such as digging out around the perimeter and/or lining the perimeter with landscape edging. Don't forget to account for water drainage.

X3.1.3.1 Check and maintain the depth of the loose-fill surfacing material. To maintain the right amount of loose-fill materials, mark the correct level on play equipment support posts. That way you can easily see when to replenish and/or redistribute the surfacing.

X3.1.3.2 Do not install loose-fill surfacing over hard surfaces such as concrete or asphalt.

X3.1.4 Poured-In-Place Surfaces or Pre-Manufactured Rubber Tiles — You may be interested in using surfacing other than loose-fill materials – like rubber tiles or poured-in-place surfaces.

X3.1.4.1 Installations of these surfaces generally require a professional and are not “do-it-yourself” projects.

X3.1.4.2 Review surface specification before purchasing this type of surfacing. Ask the installer/manufacturer for a report showing that the product has been tested to the following safety standard: ASTM F 1292 Standard Specification for Impact Attenuation of Surfacing Materials within the Use Zone of Playground Equipment. This report should show the specific height for which the surface is intended to protect against serious head injury. This height should be equal to or greater than the fall height – vertical distance between a designated play surface (elevated surface for standing, sitting, or climbing) and the protective surfacing below – of your play equipment

X3.1.4.3 Check the protective surfacing frequently for wear.

X3.1.5 Placement — Proper placement and maintenance of protective surfacing is essential. Be sure to:

X3.1.5.1 Extend surfacing at least 6 feet from the equipment in all directions.

X3.1.5.2 For to-fro swings, extend protective surfacing in front of and behind the swing to a distance equal to twice the height of the top bar from which the swing is suspended.

⁹This information has been extracted from the CPSC publications “Playground Surfacing — Technical Information Guide” and “Handbook for Public Playground Safety.” Copies of these reports can be obtained by sending a postcard to the: Office of Public Affairs, U.S. Consumer Product Safety Commission, Washington, D.C., 20207 or call the toll-free hotline: 1-800-638-2772.

The American Society for Testing and Materials takes no position respecting the validity of any parent right asserted in connection with any item mentioned in this standard. Users of this standard are expressly advised that determination of the validity of any such parent rights, and the risk of infringement of such rights, are entirely their own responsibility.

The standard is subject to revision at any time by the responsible technical committee and must be reviewed every five years and if not revised, either approved or withdrawn. Your comments are invited either for revision of this standard or for additional standards and should be addressed to ASTM Headquarters. Your comments will receive careful consideration at a meeting of the responsible technical committee, which you may attend. If you feel that your comments have not received a fair hearing you should make your views known to the ASTM Committee on Standards. 100 Barr Harbor Drive, West Conshohocken, PA 19428.



IT IS IMPORTANT TO CHECK AND TIGHTEN ALL HARDWARE AT THE BEGINNING AND DURING THE SEASON AS THEY MAY LOOSEN DUE TO WOOD EXPANSION AND CONTRACTION.

At the beginning of each play season

- Tighten all hardware.
- Lubricate all metallic moving parts per manufacturer's instructions.
- Check all protective coverings on bolts, pipes, edges, and corners. Replace if they are loose, cracked, or missing.
- Check all moving parts including swing seats, ropes, cables, and chains for wear, rust, or other deterioration. Replace as needed.
- Check metal parts for rust. If found, sand and repaint using a non lead-based paint meeting the requirements of 16 CFR 1303.
- Check all wood members for deterioration and splinters. Sand down splinters and replace deteriorating wood members.
- Reinstall any plastic parts, such as swing seats or any other items that were removed for the cold season.
- Rake and check depth of loose fill protective surfacing materials to prevent compaction and to maintain appropriate depth. Replace as necessary.

Twice a month during play season

- Tighten all hardware.
- Check all protective coverings on bolts, pipes, edges, & corners. Replace if they are loose, cracked, or missing.
- Rake and check depth of loose fill protective surfacing materials to prevent compaction and to maintain appropriate depth. Replace as necessary.

Once a month during play season.

- Lubricate all metallic moving parts per manufacturer's instructions.
- Check all moving parts including swing seats, ropes, cables, and chains for wear, rust, or other deterioration. Replace as needed.

At the end of each play season or when the temperature drops below 32° F

- Remove plastic swing seats and other items as specified by the manufacturer and take indoors or do not use.
- Rake and check depth of loose fill protective surfacing materials to prevent compaction and to maintain appropriate depth. Replace as necessary.

Additional Maintenance

- Check the swing beam and hardware every two weeks due to wood expansion and contraction. It is particularly important that this procedure be followed at the beginning of each season.
- Inspect wood parts monthly. The grain of the wood sometimes will lift in the dry season causing splinters to appear. Light sand may be necessary to maintain a safe playing environment. Treat your playset with stain regularly, to help prevent severe checking/ splitting and other weather damage.
- A waterborne transparent stain has been applied to your playset. This is done for color only. Once or twice a year, depending on your climate conditions, you must apply some type of protection (sealant) to the wood of your unit. Prior to the application of sealant, lightly sand any "rough" spots on your playset. Please note this is a requirement of your warranty.
- Assembling and maintaining the playset on a level location is very important. As your children play, your playset will slowly dig its way into the soil, and it is very important that it settles evenly. Make sure the playset is level and true one each year or at the beginning of each play season.

Disposal Instructions

When the Playcenter use is no longer desired, it should be disassembled and disposed of in such a way that no unreasonable hazards will exist at the time the unit is discarded.

Third Party Assembly

Customer may, in their sole discretion, elect to use a third party person or service to assemble this product. Backyard Discovery assumes no responsibility or liability for any charge incurred by the Customer for any assembly services'. Please see our warranty for more information about damaged and missing part replacement coverage. Backyard Discovery will not reimburse Customer for the price of parts purchased.

OWNERS SHALL BE RESPONSIBLE FOR MAINTAINING THE LEGIBILITY OF THE WARNING LABELS



Your Backyard Discovery structure is designed and constructed of quality materials. As with all outdoor products it will weather and wear. To maximize the enjoyment, safety and life of your structure it is important that you properly maintain it.

About Our Wood

Backyard Discovery uses 100% Cedar (C. Lanceolata) wood. Although we take great care in selecting the best quality lumber available, wood is still a product of nature and susceptible to weathering which can change the appearance of your set.

What causes weathering? Does it affect the strength of my product?

One of the main reasons for weathering is the effects of water (moisture); the moisture content of the wood at the surface is different than the interior of the wood. As the climate changes, moisture moves in or out of the wood, causing tension which can result in checking and or warping. You can expect the following due to weathering. These changes will not affect the strength of the product:

1. Checking is surface cracks in the wood along the grain. A post (4" x 4") will experience more checking than a board (1" x 4") because the surface and interior moisture content will vary more widely than in thinner wood.

2. Warping results from any distortion (twisting, cupping) from the original plane of the board and often happens from rapid wetting and drying of the wood.

3. Fading happens as a natural change in the wood color as it is exposed to sun-light and will turn grey over time.

How can I reduce the amount of weathering to wood product?

1. Your wood product is coated with a water-based stain. Sunlight will break down the coating, so we recommend applying a water repellent or stain on a yearly basis (see your local stain and paint supplier for a recommended product). You must apply some type of protection (sealant) to the wood of your product. **Please note this is a requirement of your warranty.** Most weathering is just the normal result of nature and will not affect safety. However if you are concerned that a part has experienced a severe weathering problem please call our customer service department for further assistance.

2. Inspect wood parts monthly. The grain of the wood sometimes will lift in the dry season causing splinters to appear. Light sanding may be necessary to maintain a safe environment. Treating your Product with protection (sealant) after sanding will help prevent severe checking/ splitting and other weather damage.



Protrusion Hazard

Incorrect

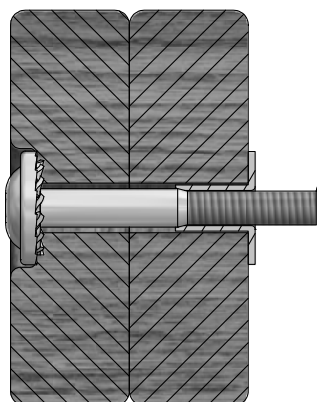

If you see exposed threads and your bolt protrudes beyond the T-Nut you may have overtightened the bolt or used incorrect hardware. If you've overtightened, remove the bolt and add washers to eliminate the protrusion.

Correct

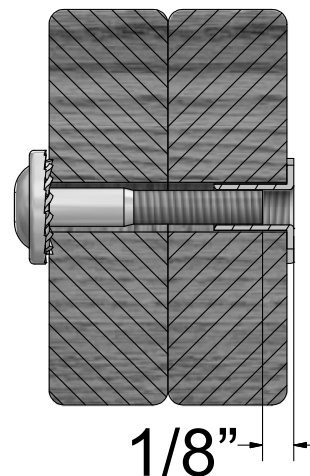

Proper Hardware Assembly

Bolt and T-Nut Assembly

Tap T-nut into the provided hole. Insert your bolt through the lock washer and insert into the provided hole opposite from the T-Nut. Turn clockwise to thread into T-nut. Do not completely tighten until instructed.

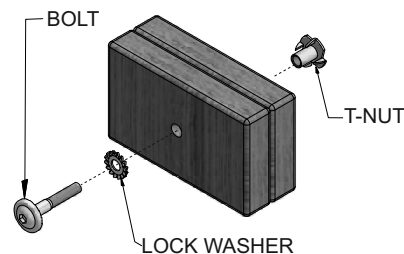

Bolt and Barrel Nut Assembly

Insert barrel nut through the lock washer and press the pair through the provided hole. Insert your bolt through the second lock washer and insert the pair into the provided hole opposite from the barrel nut. Turn clockwise to thread into the barrel nut. Do not completely tighten until instructed.

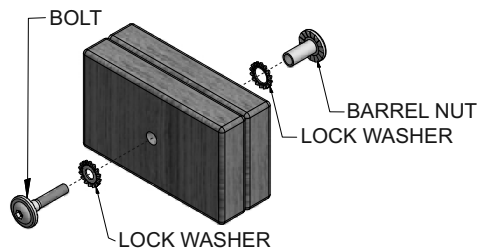

Lag Assembly

Normally there will be a pre-drilled pilot hole on assemblies that require a Lag Screw. If there is no pilot hole, line up the two boards as they are to be attached and use the factory drilled hole as a guide to drill another pilot hole into the adjoining board. This will keep the wood from splitting. Only a lock washer is required for steps with Lag Screws.

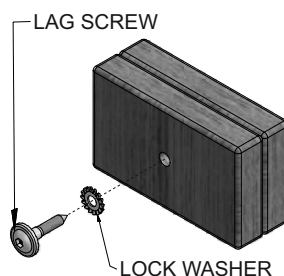



ASSEMBLY TIP:

Keep and eye out for these boxes which will contain helpful pictures and information making the assembly process as quick and painless as possible.

Sorting Wood



When removing the wood from the boxes we recommend arranging them by part number before you begin assembly. This will allow for faster assembly and easily identify any parts that may be missing or damaged.

Sorting Hardware

NUT BARREL
H100545



SCREW
H100695



T-NUT
H100699

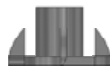

WASHER FLAT
H100706



BOLT HEX
H100716

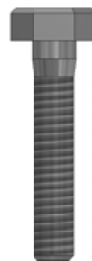

BOLT
H100718



SCREW PWH
H100742



To help with assembly we recommend sorting your hardware bags with the seven digit alpha-numeric number printed on the bags or by hardware type (i.e. bolts, nuts, etc.). Organizing your hardware will make assembly easier.

Hardware Identification

Hardware bags are printed with a seven digit alpha-numeric part number. During assembly you only need to reference the last three digits of the part number as noted in each step. This will make finding the correct hardware easier.

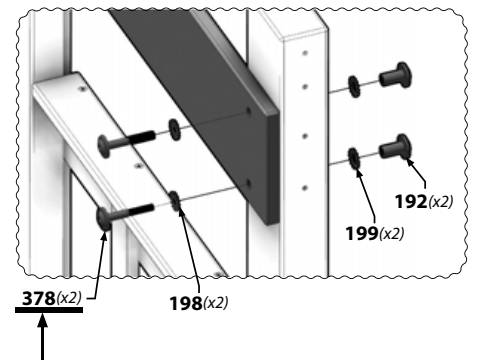
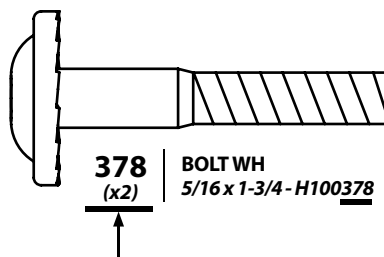

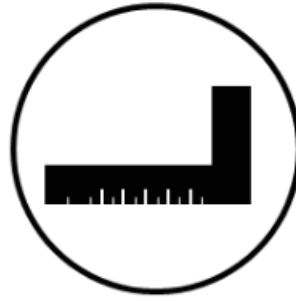
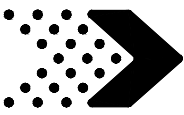

Icons and their uses you will see throughout this manual



You will need to make sure that your assembly is square before tightening your bolts.



For proper assembly you will need to ensure that your structure is level before proceeding to the next step.



Some steps in the assembly process will require an extra set of hands. Make sure you have a helper available.



This icon shows the size of an open ended wrench. Using the wrench as the fraction bar.



When you see this icon you will need a socket wrench. The icons below show the size of attachments needed for assembly.



This icon warns you to not over tighten your bolts. This is to prevent structural damage and also splintering your wood.



This icon will show you what drill attachments are needed. For this example you will need a Phillips head attachment, 1/4 driver, and 1/8 drill bit.

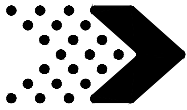

Selecting the correct location for your play product is important for your children's safety and the product's longevity.

- The safe play area refers to a zone extending 6 ft. beyond the play product on all sides, including the space above the play product.

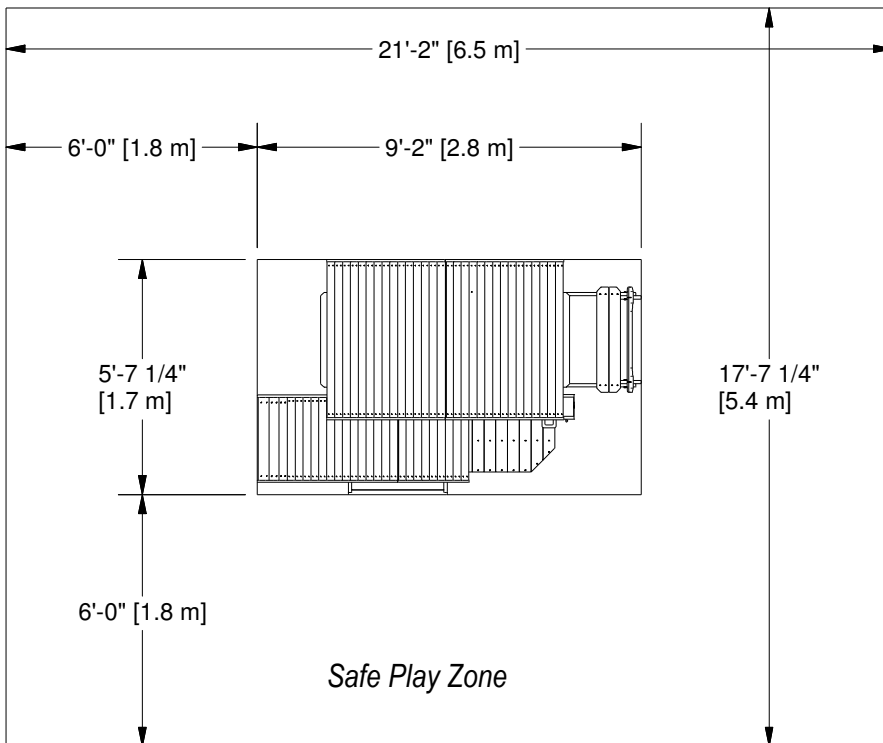
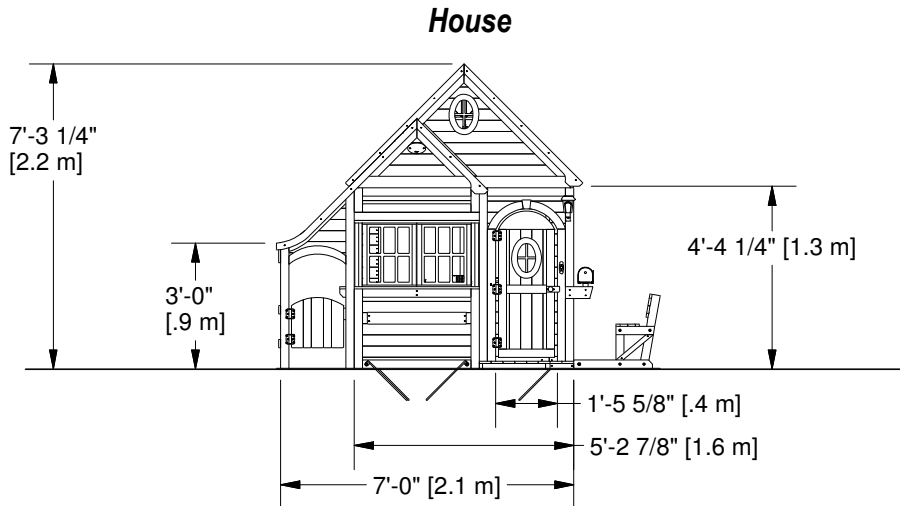

Ground Dimension

9' - 2" (2.8m) x 5' - 7 1/4" (1.7m) x 7' - 3 1/4" (2.2m)

Safe Play Area

21' - 2" (6.5m) x 17' - 7 1/4" (5.4m)

General Information:

Your set has been designed and engineered for children only and for residential use only.
 A maximum of 150 lbs. per child is recommended for play activities designed for individual use.
 A maximum of 120 lbs. per child is recommended for play activities designed for multiple child use.
 A maximum of 9 children is recommended for this playhouse.

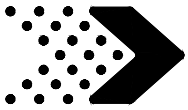

AB1 | GABLE CLEAT - W4L11791
(x2) | 1/2"x2 3/8"x11 3/4" (12x60x300)



E1 | SUPPORT - W4L12669
(x1) | 1 7/16"x3 3/8"x9 13/16" (36x86x250)

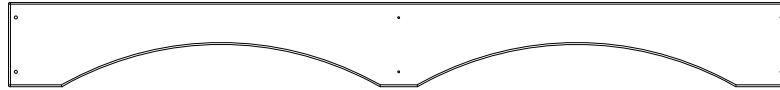

G1 | TOP RAIL - W4L08976
(x1) | 15/16"x5 1/4"x48 13/16" (24x134x1240)



H1 | DOOR TRIM - W4L08946
(x1) | 15/16"x2 5/8"x3 3/8" (24x66x86)

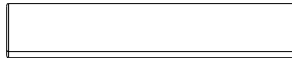

H2 | WINDOW TRIM - W4L08951
(x2) | 15/16"x3 3/8"x18 1/4" (24x86x464)

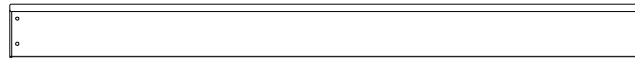

H3 | TOP RAIL - W4L11786
(x1) | 15/16"x3 3/8"x39 5/8" (24x86x1007)

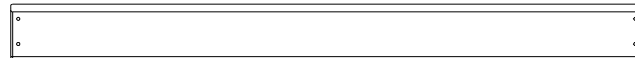

H4 | TOP RAIL - W4L08970
(x1) | 15/16"x3 3/8"x39 1/2" (24x86x1004)

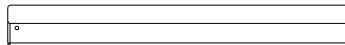

H6 | TOP RAIL - W4L11787
(x1) | 15/16"x2 1/16"x17 15/16" (24x53x455)



H7 | TOP RAIL - W4L11794
(x1) | 15/16"x3 3/8"x31 1/2" (24x86x800)



H8 | TOP RAIL - W4L11788
(x1) | 15/16"x3 3/8"x33 11/16" (24x86x856)

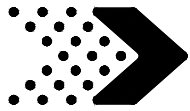

H9 | SUPPORT - W4L12658
(x4) | 15/16"x3 3/8"x9 13/16" (24x86x250)



H10 | FLOWER BOX - W4L11674
(x1) | 15/16"x3 3/8"x26 7/16" (24x86x672)

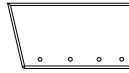

H11 | FLOWER BOX - W4L08988
(x2) | 15/16"x3 3/8"x6 9/16" (24x86x166)



H12 | SUPPORT - W4L12661
(x1) | 15/16"x3 3/8"x7 7/8" (24x86x200)



H13 | TOP RAIL - W4L12666
(x1) | 15/16"x3 3/8"x30 3/8" (24x86x772)



H14 | TOP RAIL - W4L12667
(x1) | 15/16"x3 3/8"x30 3/8" (24x86x772)



J1 | SUPPORT - W4L08949
(x4) | 15/16"x2 3/8"x4 3/16" (24x60x107)



J2 | BAY WINDOW - W4L08975
(x1) | 15/16"x2 3/8"x35 13/16" (24x60x910)



J3 | WINDOW POST - W4L08978
(x1) | 15/16"x2 3/8"x23 9/16" (24x60x599)



J4 | SUPPORT - W4L08979
(x2) | 15/16"x2 3/8"x10 1/8" (24x60x257)



J5 | SUPPORT - W4L12657
(x2) | 15/16"x2 3/8"x10 3/16" (24x60x258)



J7 | FLOWER BOX - W4L08989
(x1) | 15/16"x2 3/8"x26 7/16" (24x60x672)

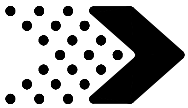

J8 | CHAIR UPRIGHT - W4L11684
(x2) | 1"x2 3/8"x12" (24x60x305)



J9 | CHAIR UPRIGHT - W4L11685
(x2) | 1"x2 3/8"x21 1/2" (24x60x546)



J10 | BENCH GROUND BOARD - W4L11688
(x2) | 1"x2 3/8"x22 1/2" (24x60x573)



J11 | CHAIR RAIL - W4L11686
(x2) | 1"x2 3/8"x11 1/8" (24x60x284)

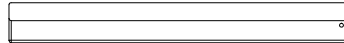

J12 | TOP RAIL - W4L12668
(x1) | 15/16"x2 1/16"x17 13/16" (24x53x452)

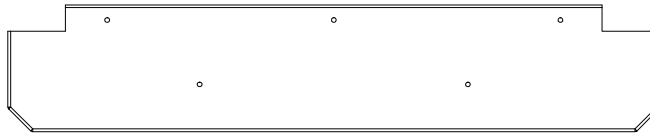

K1 | WINDOW TRIM - W4L08948
(x2) | 5/8"x5 1/4"x27 3/16" (16x134x690)

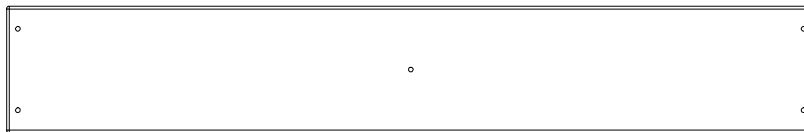

K2 | SHELF - W4L12660
(x2) | 5/8"x5 1/4"x33 11/16" (16x134x856)

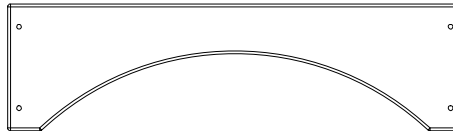

K3 | TRIM - W4L11680
(x1) | 5/8"x5 1/4"x18 15/16" (16x134x481)

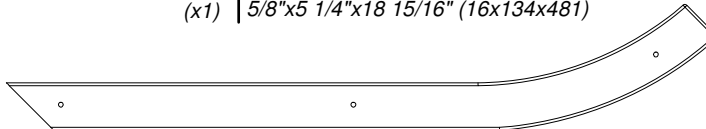

K4 | FASCIA BOARD - W4L11795
(x1) | 5/8"x5 1/4"x29 5/8" (16x133x752)

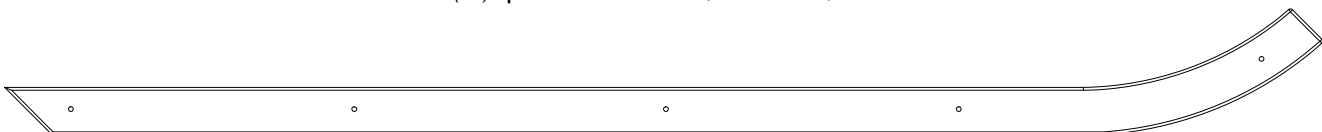

K5 | FASCIA BOARD - W4L11678
(x1) | 5/8"x5 1/4"x55" (16x133x1395)

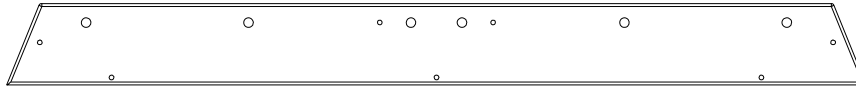
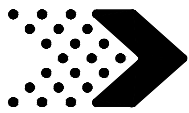

M1 | WINDOW TRIM - W4L08950
(x2) | 5/8"x3 3/8"x35 13/16" (16x86x910)

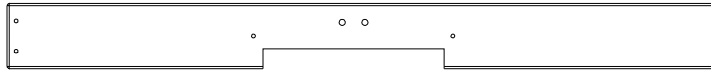

M2 | SHELF - W4L11796
(x1) | 5/8"x3 3/8"x37 1/4" (16x86x946)



M3 | FASCIA BOARD - W4L08986
(x3) | 5/8"x3 3/8"x48 1/8" (16x86x1222)



M4 | RAFTER - W4L11793
(x1) | 5/8"x3 3/8"x46 5/16" (16x86x1177)



M5 | FLOWER BOX - W4L11675
(x1) | 5/8"x3 3/8"x28 3/8" (16x86x720)

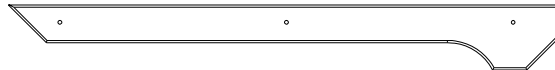

M6 | FASCIA BOARD - W4L11676
(x1) | 5/8"x3 3/8"x29" (16x86x736)



M7 | DOOR STOP - W4L11734
(x1) | 5/8"x3 3/8"x3 15/16" (16x86x100)

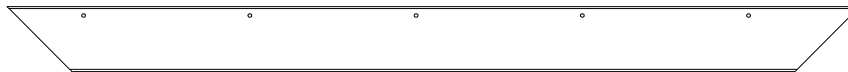

M8 | RAFTER - W4L11790
(x2) | 5/8"x3 3/8"x44 7/16" (16x86x1129)



M9 | SHELF - W4L11797
(x1) | 5/8"x3 3/8"x37 1/4" (16x86x946)

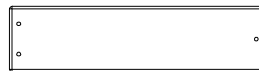

M10 | SHELF - W4L11798
(x1) | 5/8"x3 3/8"x13 5/16" (16x86x339)



M11 | SHELF - W4L11799
(x1) | 5/8"x3 3/8"x37 15/16" (16x86x964)

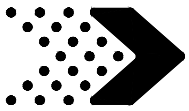

M13 | BENCH SEAT - W4L11689
(x2) | 5/8"x3 3/8"x30 1/8" (16x86x764)



M14 | BENCH BACK - W4L11690
(x1) | 5/8"x3 3/8"x30 1/8" (16x86x764)



M15 | BENCH BACK - W4L11691
(x1) | 5/8"x3 3/8"x30 1/8" (16x86x764)



M16 | SHELF - W4L12670
(x2) | 5/8"x3 3/8"x23 7/16" (16x86x596)



N1 | DOOR TRIM - W4L08944
(x1) | 5/8"x2 3/8"x37 13/16" (16x60x960)

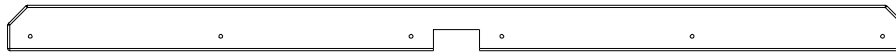

N2 | WINDOW TRIM - W4L08947
(x1) | 5/8"x2 3/8"x46 3/4" (16x60x1188)



N3 | DOOR TRIM - W4L08987
(x1) | 5/8"x2 3/8"x37 13/16" (16x60x960)

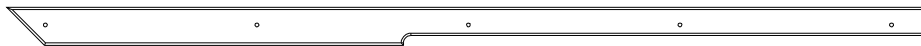

N4 | FASCIA BOARD - W4L11789
(x1) | 5/8"x2"x48 1/8" (16x50x1222)

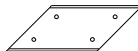

N5 | WALL CLEAT - W4L12659
(x1) | 5/8"x2 3/8"x7 1/16" (16x60x180)



N6 | WALL CLEAT - W4L11792
(x1) | 5/8"x2 3/8"x12 3/8" (16x60x315)



O1 | CHAIR RAIL - W4L11687
(x2) | 5/8"x1 3/8"x12 7/8" (16x34x328)



P1 | POST - W4L12662
(x1) | 1 7/16"x1 7/16"x4 3/4" (36x36x120)



Y1 | ARCH TRIM - W4L08945
(x2) | 5/8"x4"x12 5/8" (16x101x320)

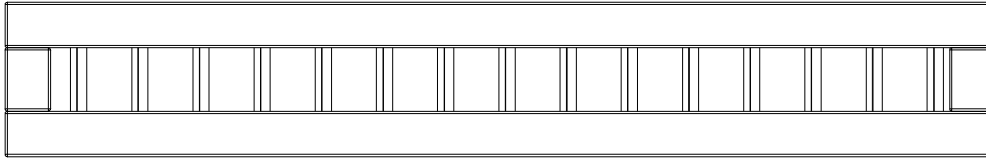
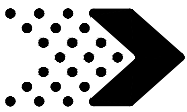

WP1 | WALL PANEL - W2A02216
(x2) | 1 1/16"x8 1/16"x51 9/16" (27x204x1310)

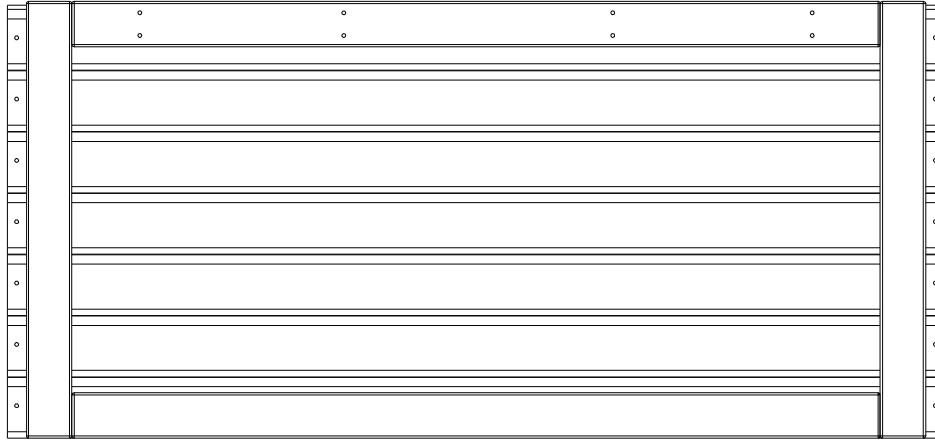

WP2 | WALL PANEL - W2A02642
(x1) | 1 1/16"x22 11/16"x48 13/16" (27x577x1240)

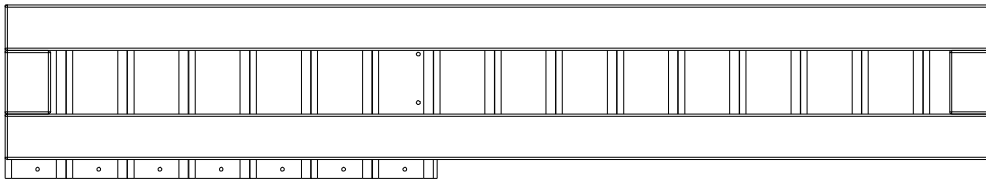

WP3 | WALL PANEL - W2A02218
(x1) | 1 1/16"x9"x51 9/16" (27x229x1310)

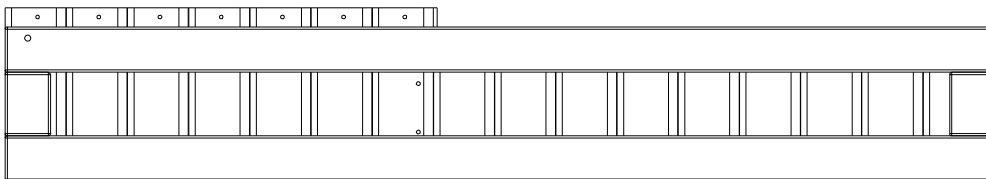

WP4 | WALL PANEL - W2A02219
(x1) | 1 1/16"x9"x51 9/16" (27x229x1310)

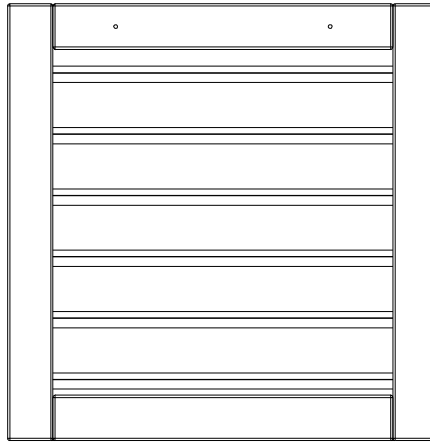
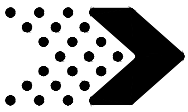

WP5 | WALL PANEL - W2A02220
(x2) | 1 1/16"x22 7/16"x22 11/16" (27x570x577)

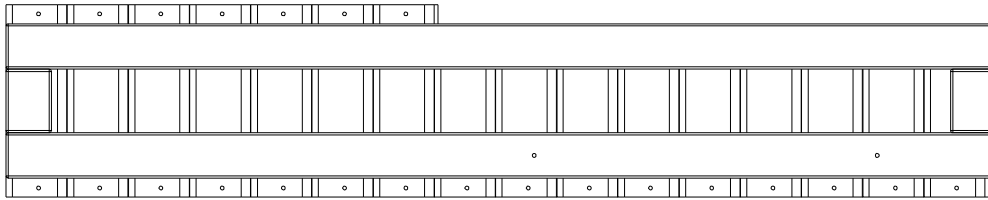

WP6 | WALL PANEL - W2A02528
(x1) | 1 1/16"x10"x51 9/16" (27x254x1310)

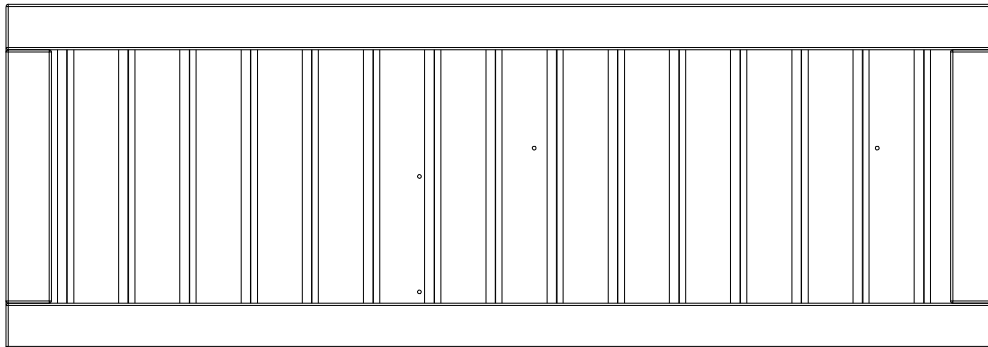

WP7 | WALL PANEL - W2A02529
(x1) | 1 1/16"x17 15/16"x51 9/16" (27x455x1310)

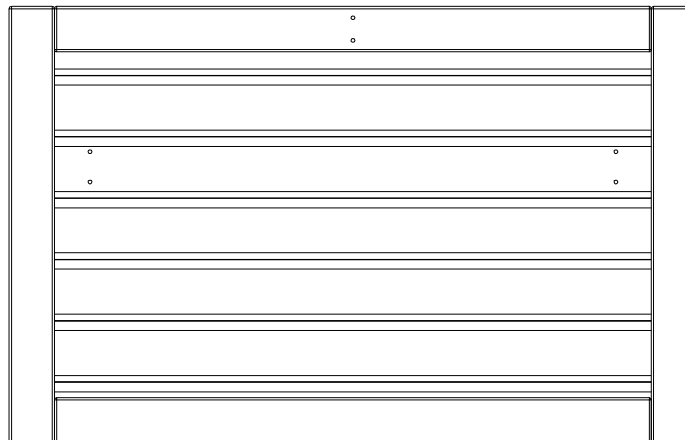

WP8 | WALL PANEL - W2A02643
(x1) | 1 1/16"x22 11/16"x35 13/16" (27x577x910)

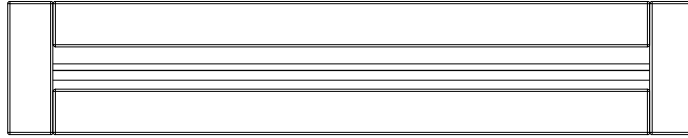
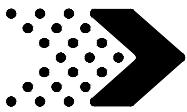

WP9 | WALL PANEL - W2A02531
(x1) | 1 1/16"x6 15/16"x35 13/16" (27x176x910)

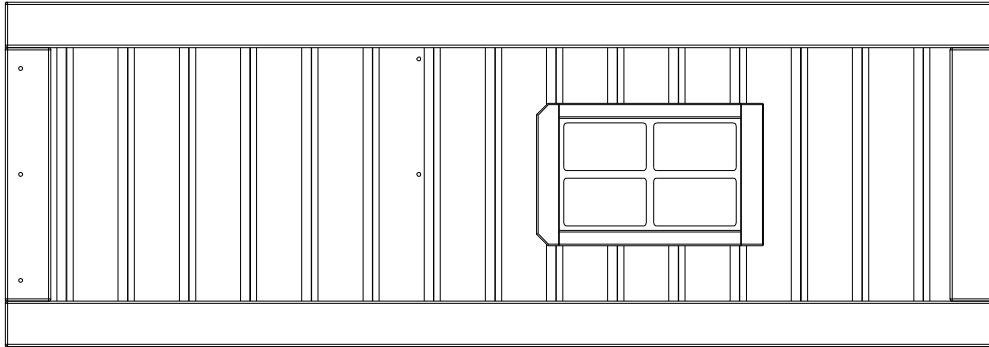

WP10 | WALL PANEL - W2A02532
(x1) | 1 1/16"x17 15/16"x51 9/16" (27x455x1310)

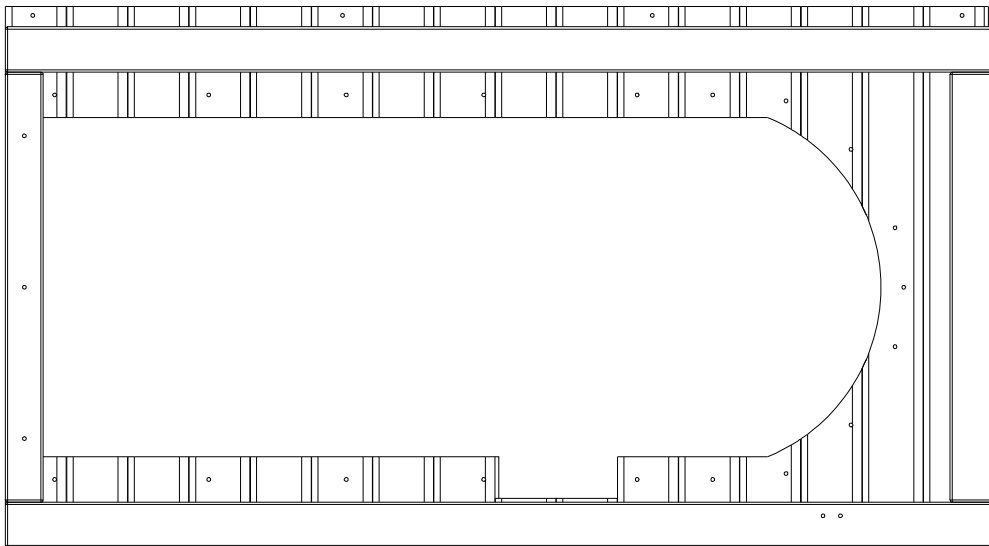

WP11 | WALL PANEL - W2A02533
(x1) | 1 1/16"x28 1/8"x51 9/16" (27x715x1310)

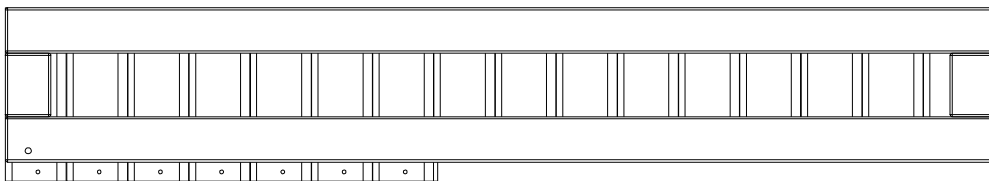

WP12 | WALL PANEL - W2A02539
(x1) | 1 1/16"x9"x51 9/16" (27x229x1310)

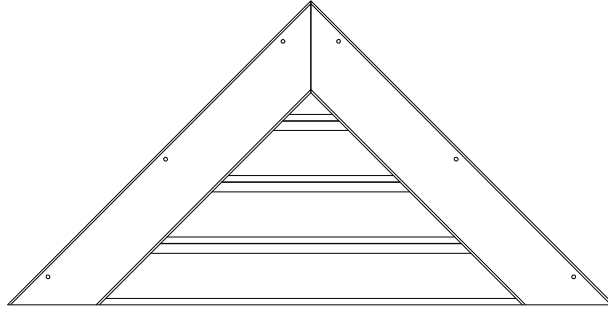
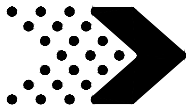

GP2 | GABLE PANEL - W2A02635
(x1) | 1 1/16"x17 7/8"x35 13/16" (27x402x803)

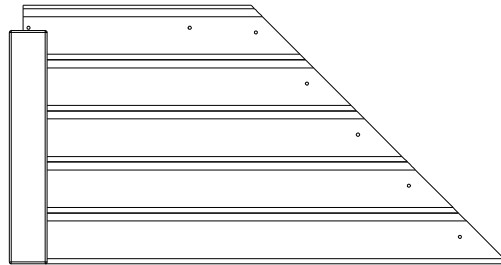

GP3 | GABLE PANEL - W2A02636
(x1) | 1 1/4"x16 1/8"x31 1/4" (32x410x794)

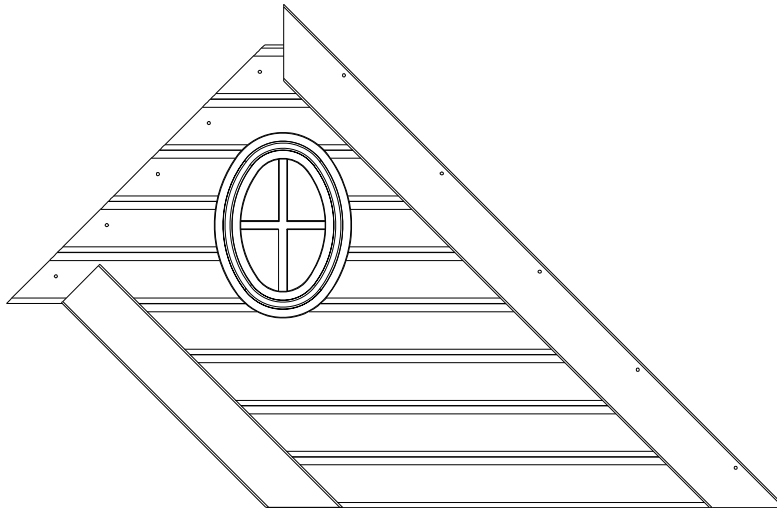

GP4 | GABLE PANEL - W2A02639
(x1) | 1 1/16"x31 7/16"x48 3/4" (27x798x1238)

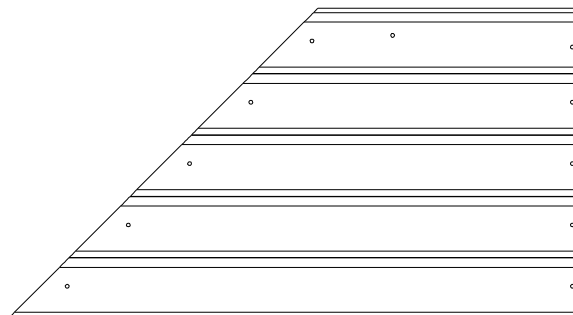

GP6 | GABLE PANEL - W2A02638
(x1) | 5/8"x16 1/8"x29 7/8" (16x410x759)

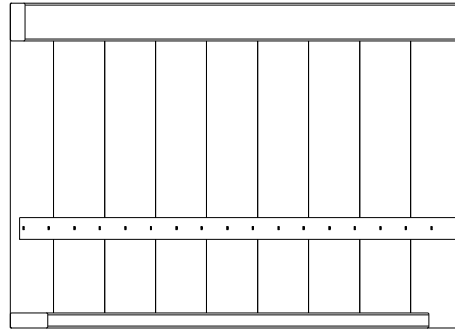
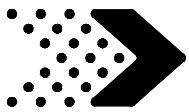

RP1 | ROOF PANEL - W2A02637
(x1) | 2 13/16"x20 1/4"x28 7/16" (71x515x722)

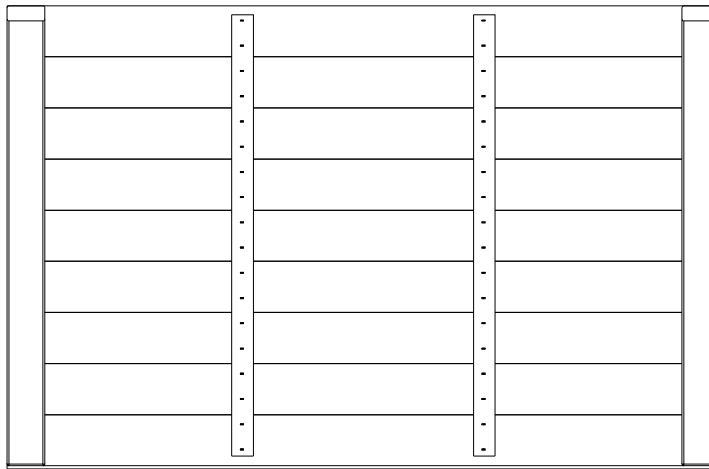

RP3 | ROOF PANEL - W2A02546
(x2) | 1 3/8"x28 7/8"x44 9/16" (35x734x1132)

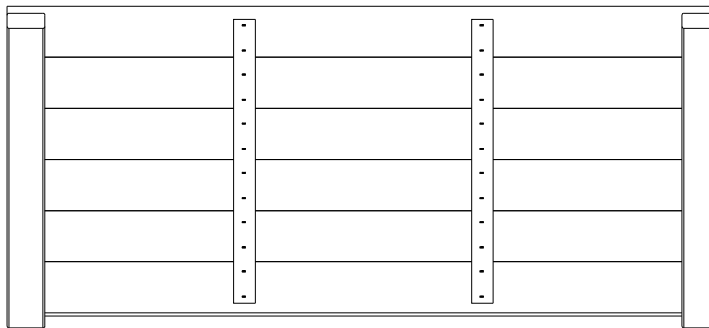

RP4 | ROOF PANEL - W2A02644
(x1) | 1 3/8"x20 1/16"x44 9/16" (35x510x1132)

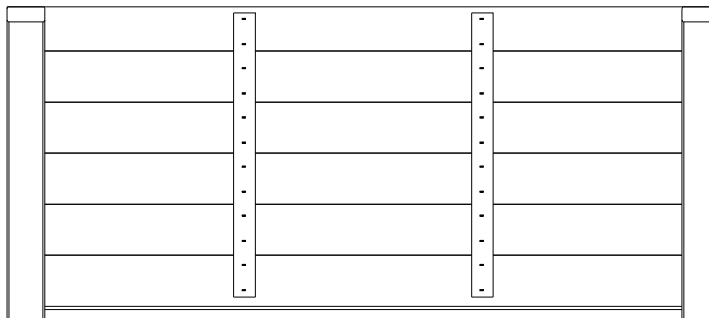

RP5 | ROOF PANEL - W2A02548
(x1) | 1 3/8"x19 5/8"x44 9/16" (35x499x1132)

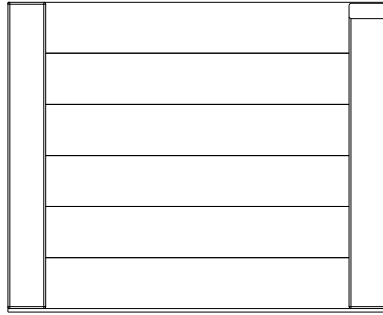
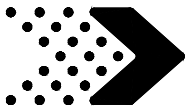

RP6 | ROOF PANEL - W2A02641
(x1) | 1 3/8"x19 3/8"x23 11/16" (35x491x602)



RP7 | ROOF PANEL - W2A02552
(x3) | 1 3/8"x3 3/8"x23 11/16" (35x86x602)

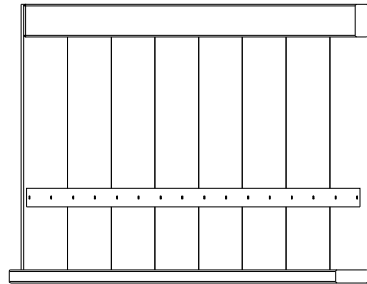

RP8 | ROOF PANEL - W2A02640
(x1) | 1 3/8"x20 1/4"x26 5/8" (71x515x675)

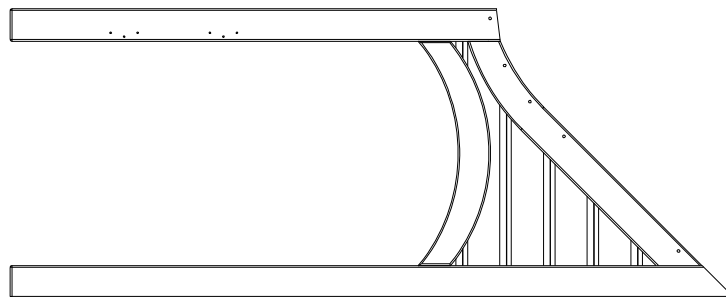

WP17 | WALL PANEL - W2A02364
(x1) | 1 1/16"x21 1/16"x52 7/8" (27x535x1342)

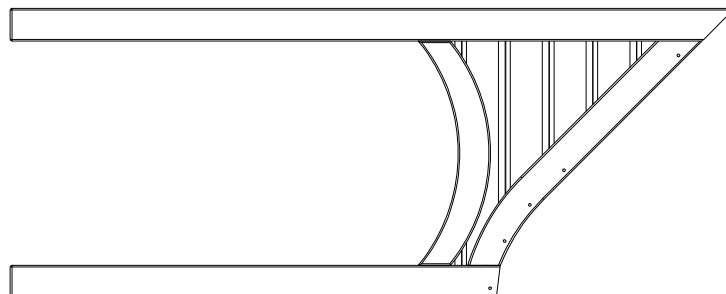

WP18 | WALL PANEL - W2A02633
(x1) | 1 1/16"x21 1/16"x52 7/8" (27x535x1342)

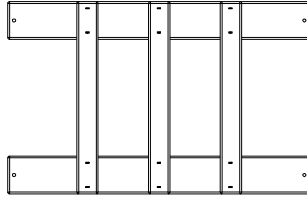
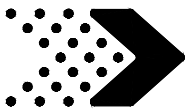

FP1 | FENCE PANEL - W2A02553
(x1) | 1 1/16"x12"x18 15/16" (27x305x481)

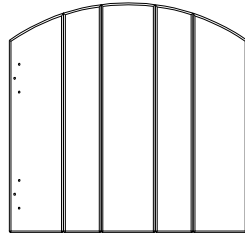

GP1 | GATE PANEL - W2A02554
(x1) | 1 1/16"x14 5/16"x14 7/8" (27x364x378)

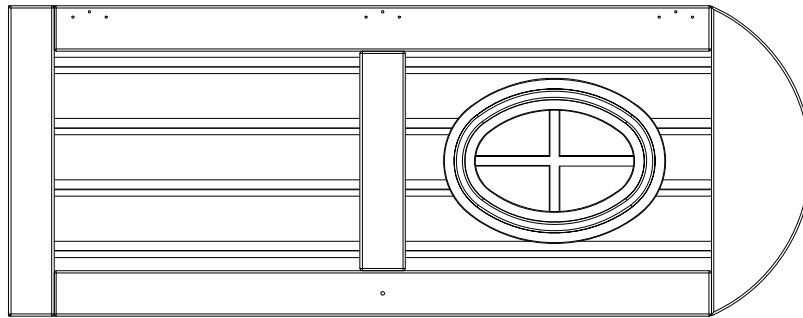

DP1 | DOOR PANEL - W2A02555
(x1) | 1 1/16"x16 1/8"x41 7/8" (27x410x1063)

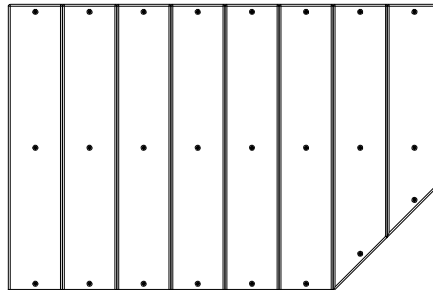

PP1 | PORCH PANEL - W2A02556
(x1) | 1 15/16"x17 15/16"x27 1/16" (50x455x688)

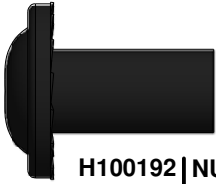
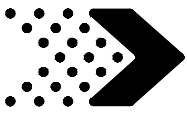

H100192 | NUT BARREL WH BLK
(x4) | 5/16x7/8

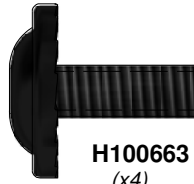

H100663 | BOLT WH BLK
(x4) | 5/16x3/4

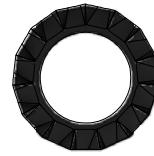

H100199 | WASHER LOCK EXT BLK
(x4) | 12x19



H100548 | NUT BARREL WH SD
(x11) | 1/4x7/8



H100547 | WASHER LOCK EXT SD
(x13) | 8x15

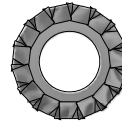

H100546 | WASHER LOCK EXT SD
(x9) | 6x15

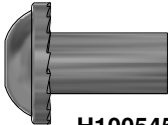

H100545 | NUT BARREL WH SD
(x2) | 1/4x5/8

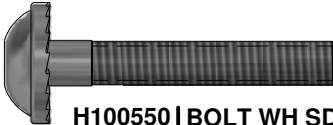

H100550 | BOLT WH SD
(x9) | 1/4x1 1/2



H100542 | SCREW PFH SD
(x38) | 8x2



H100745 | BOLT WH SD
(x2) | 1/4x1



H100541 | SCREW PFH SD
(x25) | 8x1 3/4

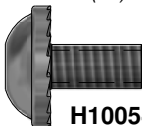

H100549 | BOLT WH SD
(x2) | 1/4x1/2



H100538 | SCREW PFH SD
(x185) | 8x1 1/2

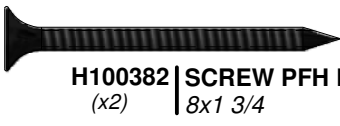

H100382 | SCREW PFH BLK
(x2) | 8x1 3/4



H100539 | SCREW PFH SD
(x11) | 8x1 1/4



H100395 | SCREW PFH BLK
(x2) | 8x3/4



H100537 | SCREW PFH SD
(x124) | 8x1

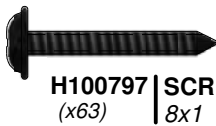

H100797 | SCREW PWH BLK
(x63) | 8x1



H100543 | SCREW PFH SD
(x4) | 8x1/2



H100392 | SCREW PWH BLK
(x52) | 8x3/4



H100202 | SCREW PWH BLK
(x35) | 8x5/8



H100544 | SCREW PWH SD
(x13) | 8x5/8



H100624 | SCREW PFH BLK
(x2) | 6x5/8

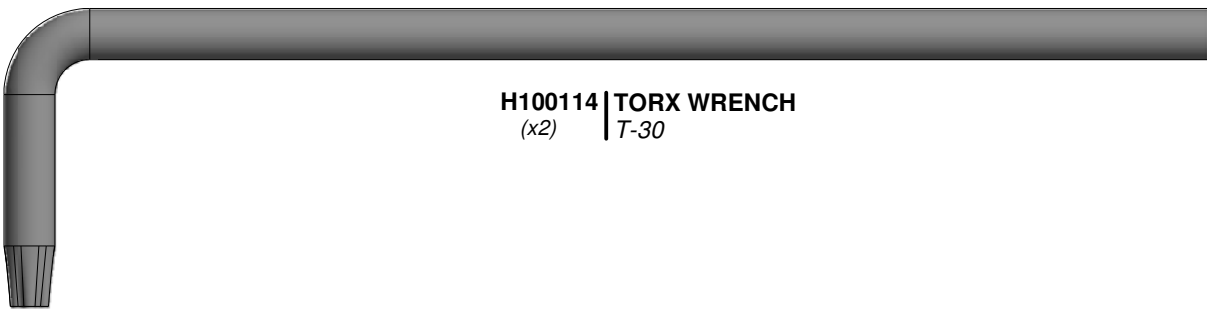

H100114 | TORX WRENCH
(x2) | T-30

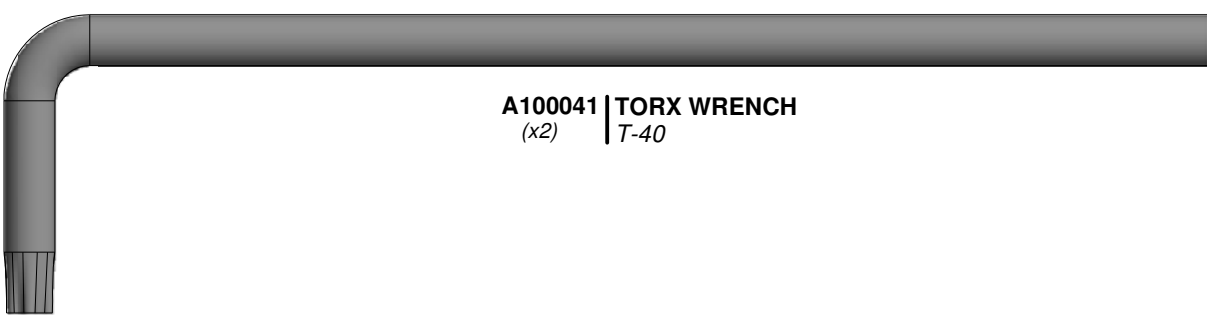

A100041 | TORX WRENCH
(x2) | T-40



H100147 | TORX BIT
(x2) | T-30



A100042 | TORX BIT
(x2) | T-40



H100764 | SCREW SETTER
(x1)

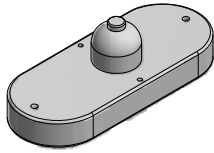
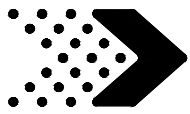

A100174 | DOOR BELL
(x1)

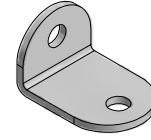

A100133 | L BRACKET WHITE 32x51
(x2)

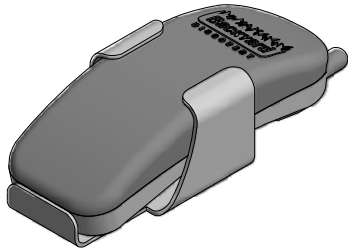

A100132 | PHONE KIT
(x1)



A100314 | "A" REVISION TAG
(x1)

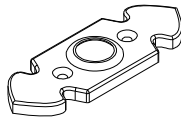

A6P00290 | DOOR BELL PLATE
(x1)

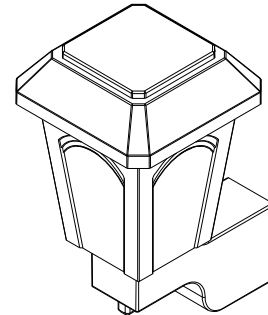

A6P00068 | OUTDOOR LIGHT FIXTURE
(x1)

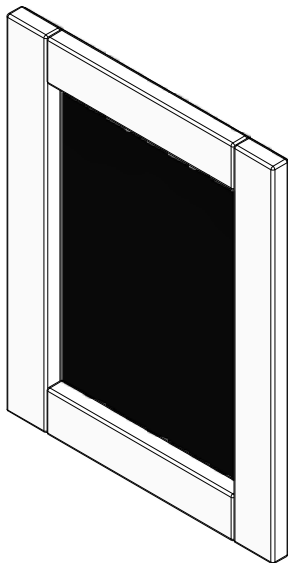

A4M00934 | CHALKBOARD
(x1)

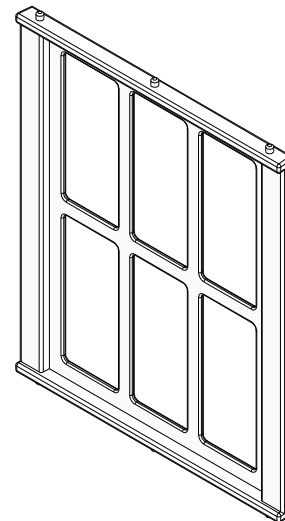

A100373 | BAY WINDOW PANEL
(x2)

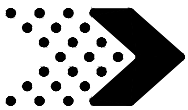

Parts Identification

Accessories (Not to Scale)



A4M00527 | GROUND STAKE REBAR
(4)



A4M00528 | BYD ID TAG (MEDIUM) AGES 2 TO 10
(x1)

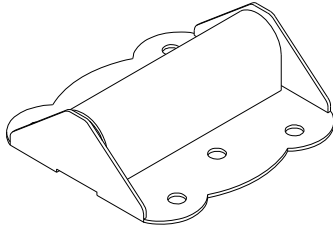

A4M00994 | HINGE (DOOR, NON-SPRING LOADED)
(x2)

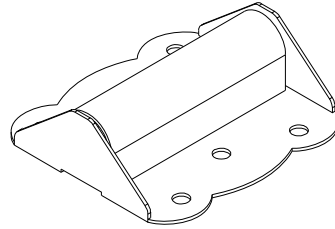

A4M00624 | HINGE (DOOR, SPRING LOADED)
(x3)

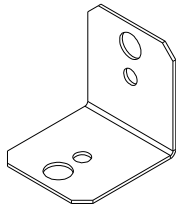

A4M00555 | 90° L-BRACKET - BLK
(x24)

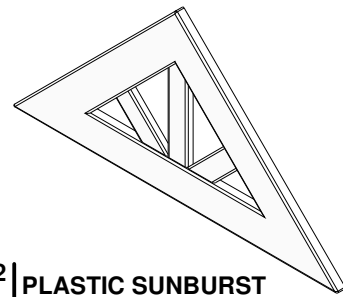

A100322 | PLASTIC SUNBURST
(x1)

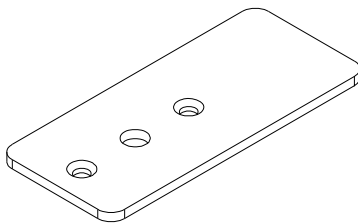

A4M00933 | DOOR STOP
(x1)



A6P00067 | KNOB - BLK
(x1)

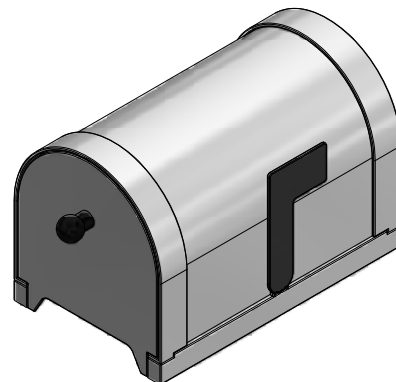

A6P00017 | MAILBOX
(x1)

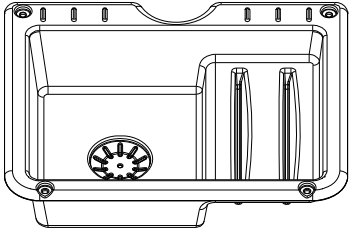
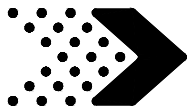

A6P00332 | PREMIUM SINK
(x1)

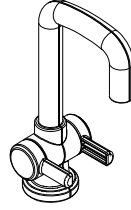

A6P00333 | FAUCET
(x1)

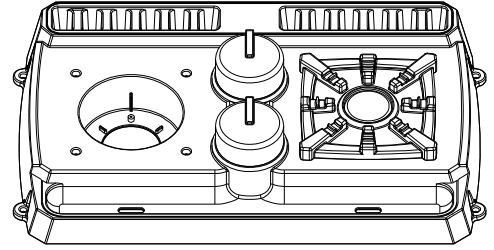

A6P00335 | STOVE BASE
(x1)

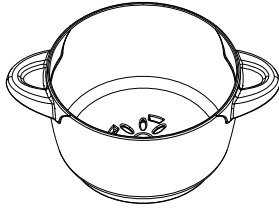

A6P00336 | BOIL POT
(x1)

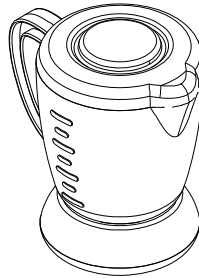

A6P00331 | BLENDER
(1)

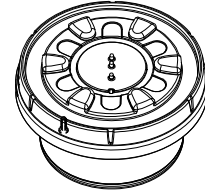

A6P00330 | INDUCTIVE BURNER
(x1)

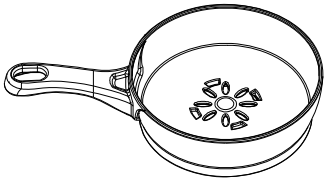

A6P00338 | FRY PAN
(x1)

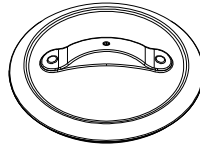

A6P00337 | POT/PAN LID
(x2)

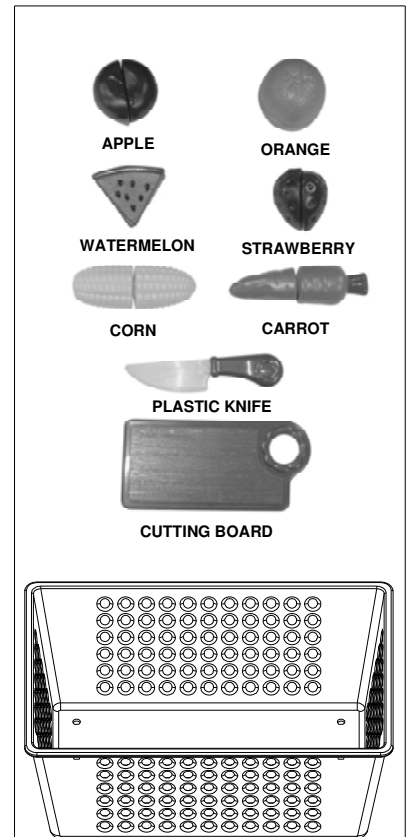

APPLE

ORANGE

WATERMELON

STRAWBERRY

CORN

CARROT

PLASTIC KNIFE

CUTTING BOARD

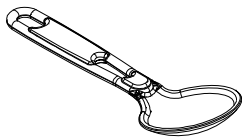

A6P00340 | LADLE
(x1)

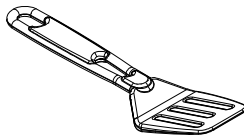

A6P00339 | SPATULA
(x1)



A4M00997 | METAL CLEAT
(x13)



**WASH TOY ACCESSORIES
THOROUGHLY BEFORE USE.
DO NOT SUBMERGE
ELECTRONIC COMPONENTS
IN WATER.**

A6P00069 | FRUIT BASKET KIT
(x1)

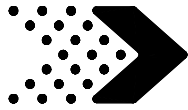

Bench Phase

STEP 1

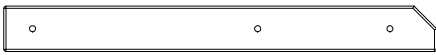

J10 | BENCH GROUND BOARD - W4L11688
(x1) | 1"x2 3/8"x22 1/2" (24x60x573)



O1 | CHAIR RAIL - W4L11687
(x1) | 5/8"x1 3/8"x12 7/8" (16x34x328)



J9 | CHAIR UPRIGHT - W4L11685
(x1) | 1"x2 3/8"x21 1/2" (24x60x546)



J8 | CHAIR UPRIGHT - W4L11684
(x1) | 1"x2 3/8"x12" (24x60x305)



J11 | CHAIR RAIL - W4L11686
(x1) | 1"x2 3/8"x11 1/8" (24x60x284)

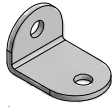

A100133 | L BRACKET WHITE 32x51
(x1)



H100550 | BOLT WH SD
(x4) | 1/4x1 1/2

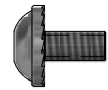

H100549 | BOLT WH SD
(x1) | 1/4x1/2

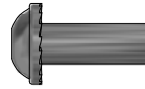

H100548 | NUT BARREL WH SD
(x5) | 1/4x7/8



H100547 | WASHER LOCK EXT SD
(x5) | 8x15



H100541 | SCREW PFH SD
(x1) | 8x1 3/4



H100546 | WASHER LOCK EXT SD
(x4) | 6x15



H100538 | SCREW PFH SD
(x2) | 8x1 1/2

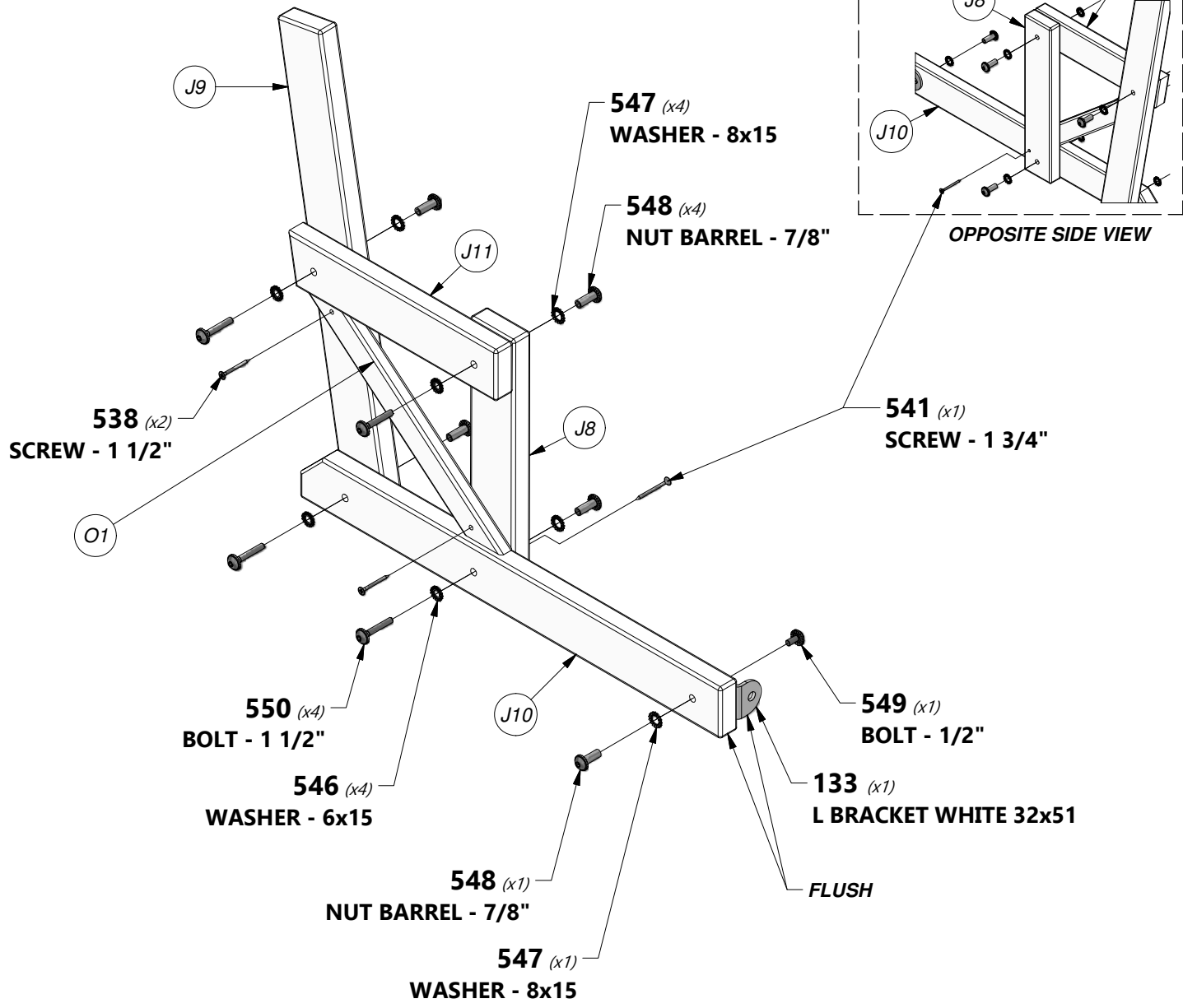

Bench Phase

STEP 2

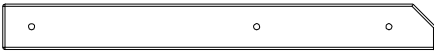

J10 | BENCH GROUND BOARD - W4L11688
(x1) | 1"x2 3/8"x22 1/2" (24x60x573)



O1 | CHAIR RAIL - W4L11687
(x1) | 5/8"x1 3/8"x12 7/8" (16x34x328)



J9 | CHAIR UPRIGHT - W4L11685
(x1) | 1"x2 3/8"x21 1/2" (24x60x546)



J8 | CHAIR UPRIGHT - W4L11684
(x1) | 1"x2 3/8"x12" (24x60x305)



J11 | CHAIR RAIL - W4L11686
(x1) | 1"x2 3/8"x11 1/8" (24x60x284)

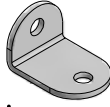

A100133 | L BRACKET WHITE 32x51
(x1)



H100550 | BOLT WH SD
(x4) | 1/4x1 1/2

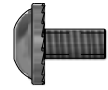

H100549 | BOLT WH SD
(x1) | 1/4x1/2

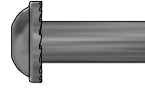

H100548 | NUT BARREL WH SD
(x5) | 1/4x7/8



H100547 | WASHER LOCK EXT SD
(x5) | 8x15

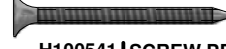

H100541 | SCREW PFH SD
(x1) | 8x1 3/4



H100546 | WASHER LOCK EXT SD
(x4) | 6x15



H100538 | SCREW PFH SD
(x2) | 8x1 1/2

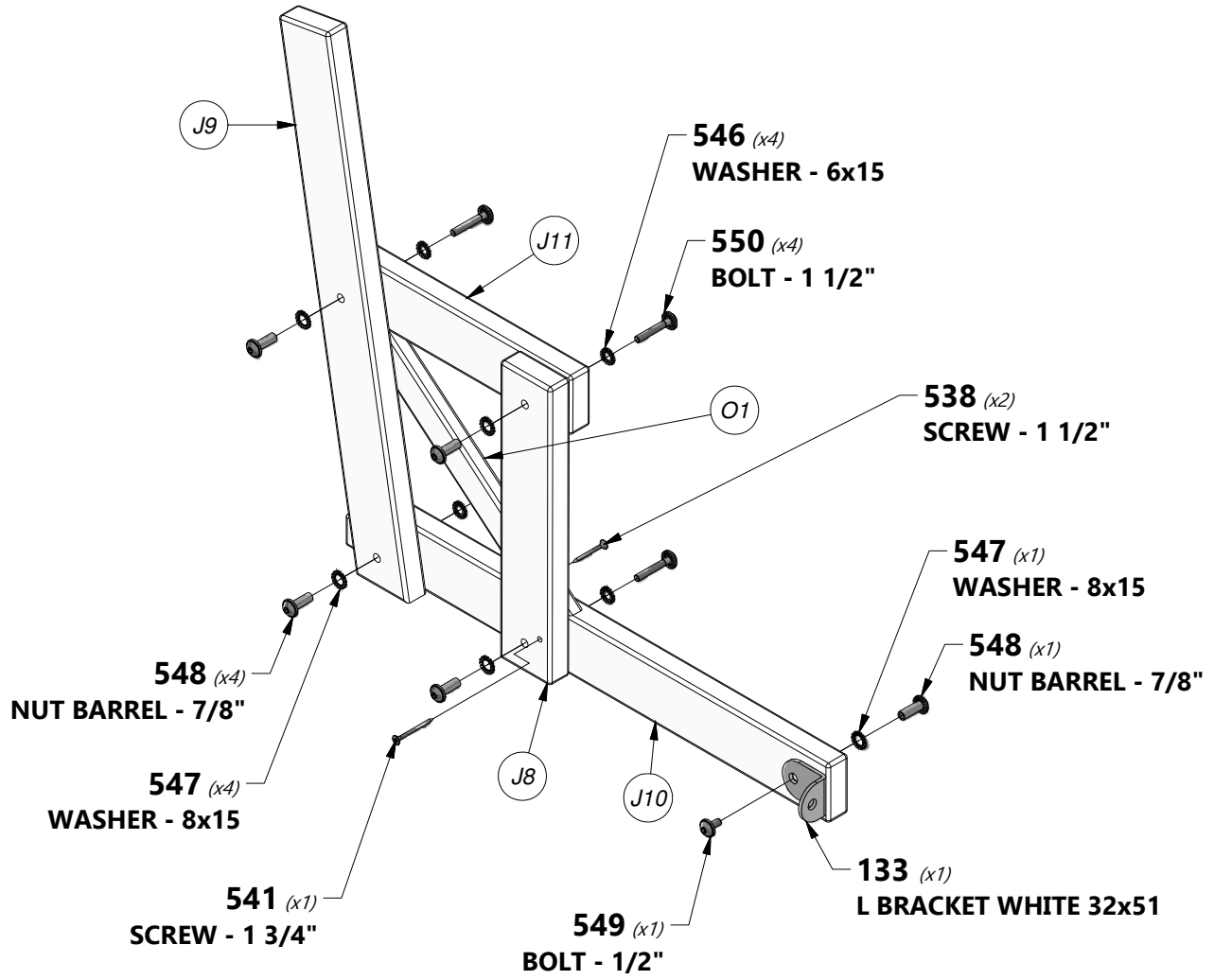

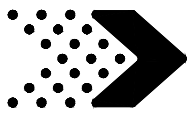

M13 | BENCH SEAT - W4L11689
(x2) | 5/8"x3 3/8"x30 1/8" (16x86x764)



H100538 | SCREW PFH SD
(x8) | 8x1 1/2

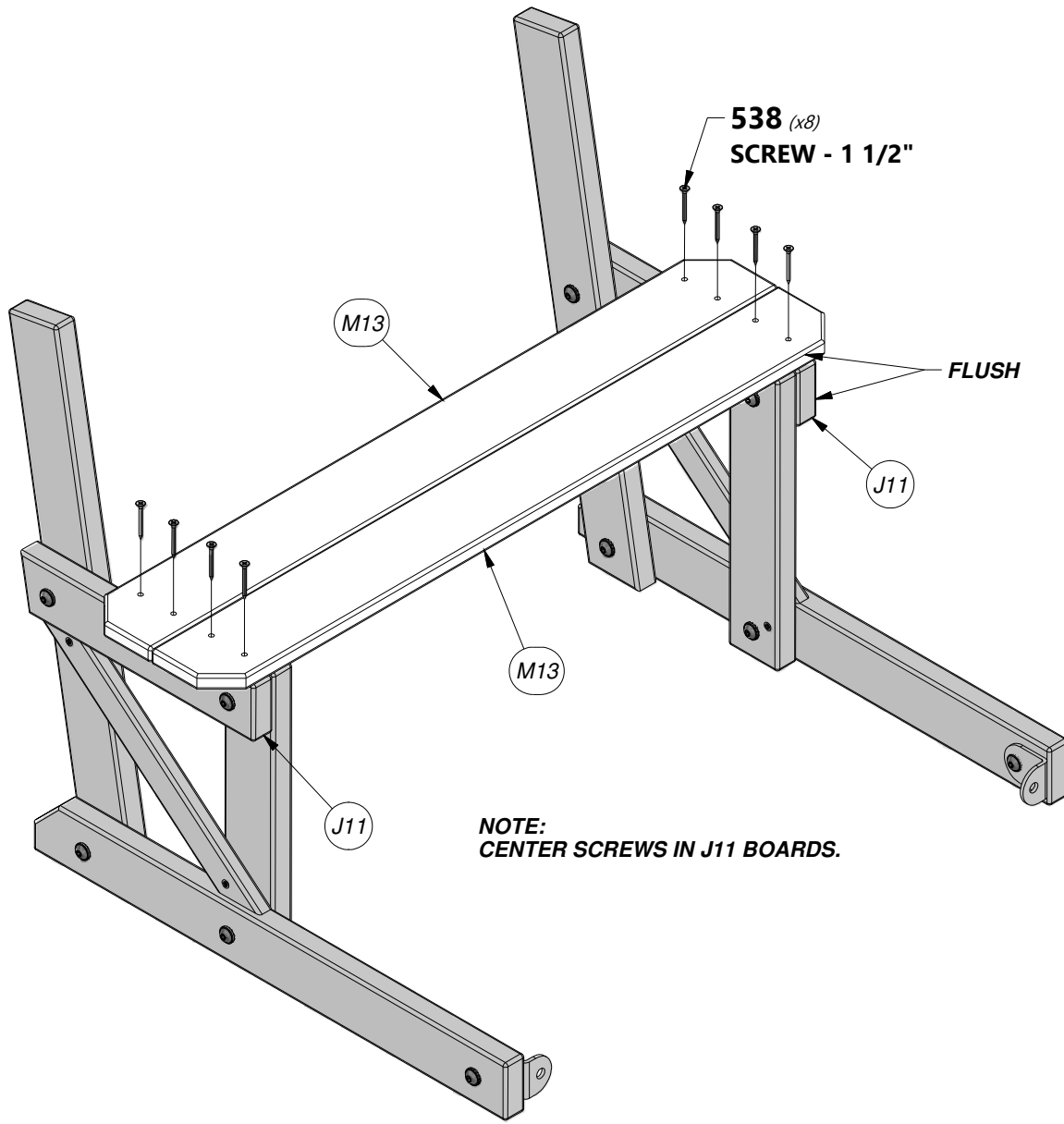

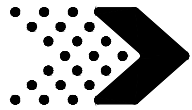

M14 | BENCH BACK - W4L11690
(x1) | 5/8"x3 3/8"x30 1/8" (16x86x764)

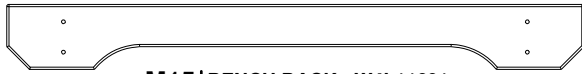

M15 | BENCH BACK - W4L11691
(x1) | 5/8"x3 3/8"x30 1/8" (16x86x764)



H100538 | SCREW PFH SD
(x8) | 8x1 1/2

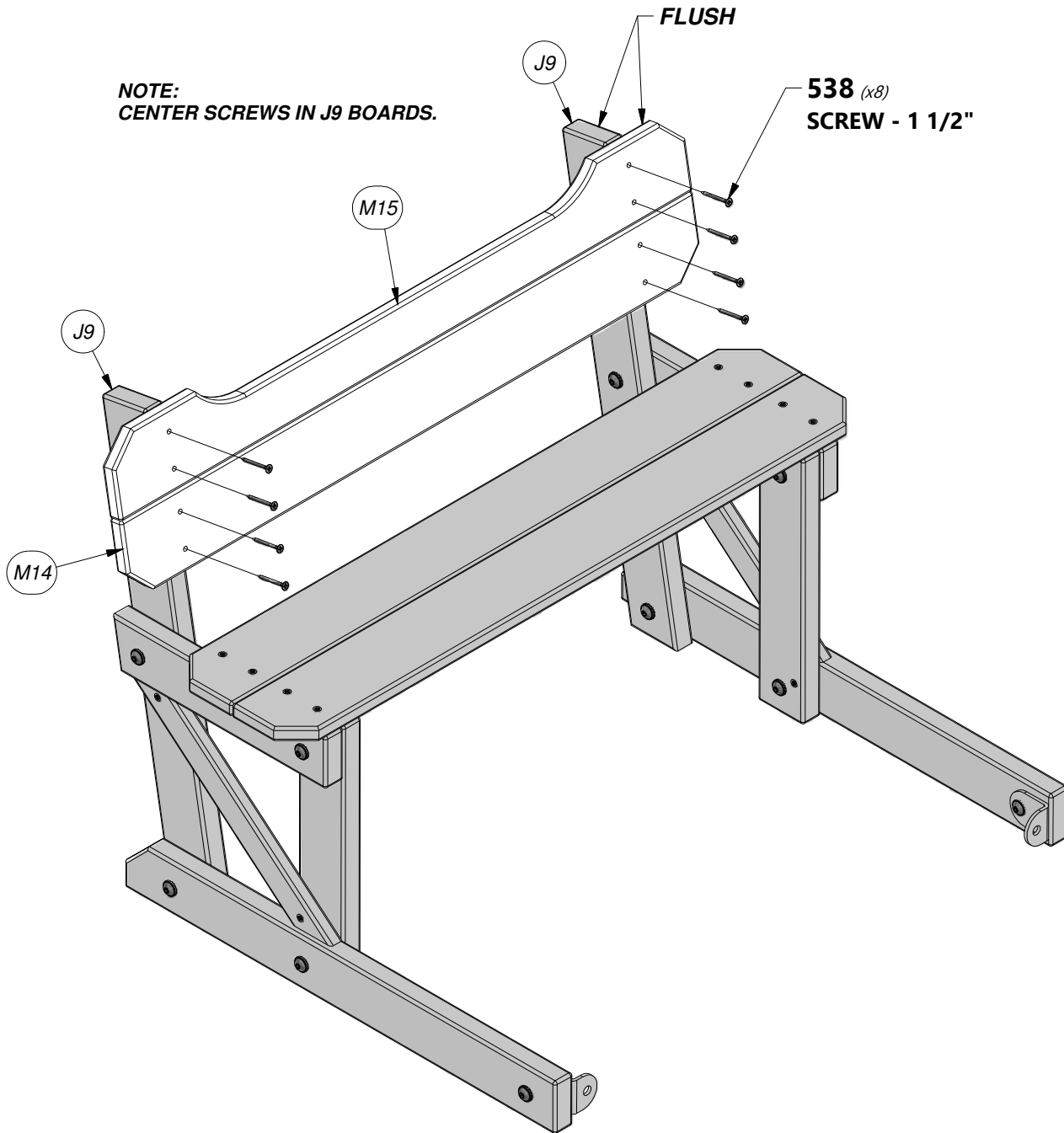

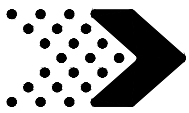

Phase 1

STEP 1

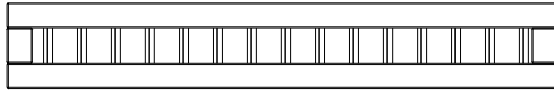

WP1 | WALL PANEL - W2A02216
(x1) | 1 1/16"x8 1/16"x51 9/16" (27x204x1310)

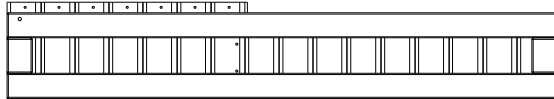

WP4 | WALL PANEL - W2A02219
(x1) | 1 1/16"x9"x51 9/16" (27x229x1310)

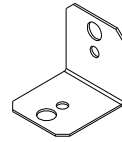

A4M00555 | 90° L-BRACKET - BLK
(x3)



H100392 | SCREW PWH BLK
(x6) | 8x3/4

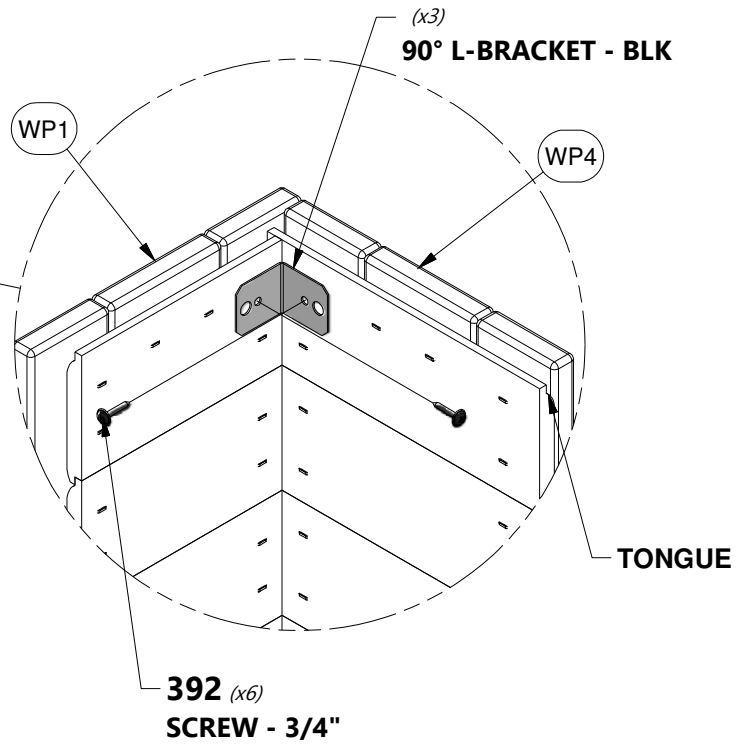
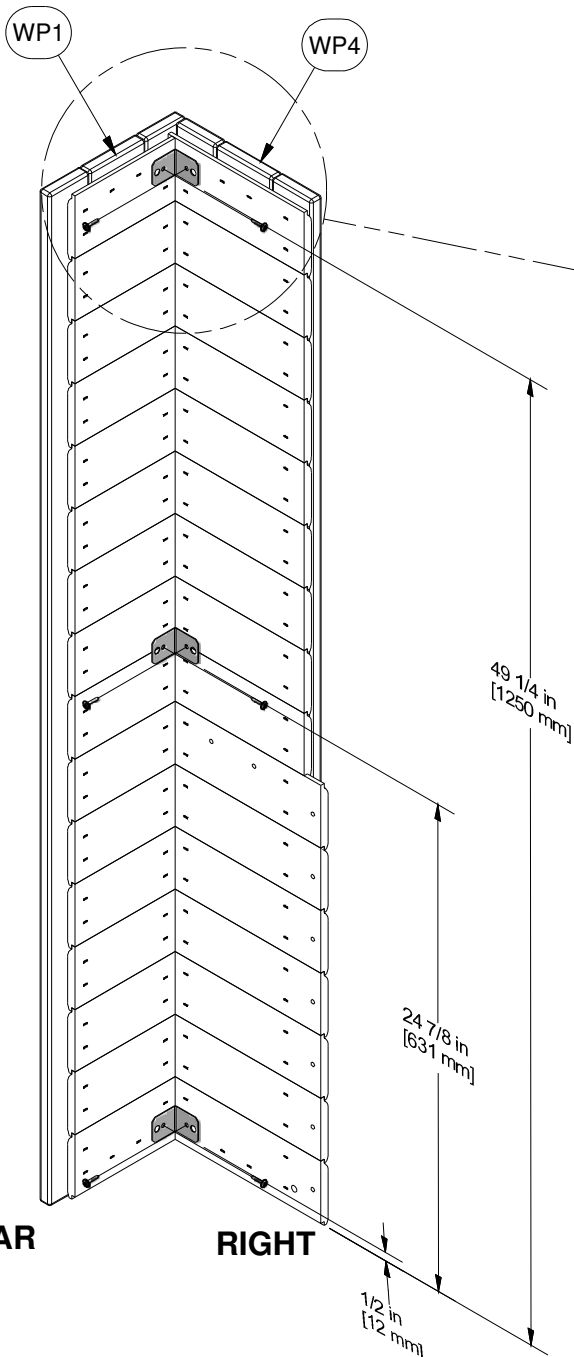

NOTE:
ALL WALL PANELS WILL HAVE
THE TONGUE FACING UPWARD
AND GROOVE FACING DOWNWARD.

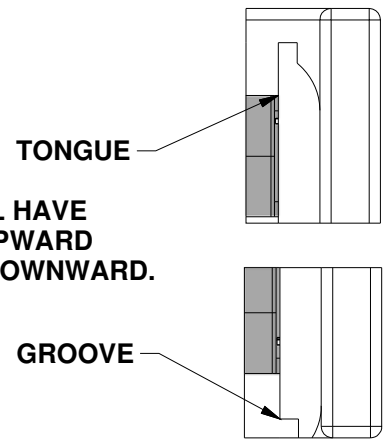

WALL PANEL SIDE VIEW

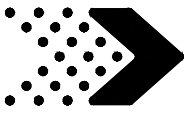

Phase 1

STEP 2

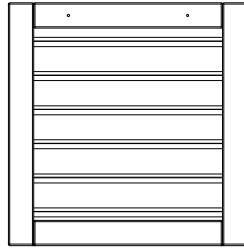

WP5 | WALL PANEL - W2A02220
(x1) | 1 1/16"x22 7/16"x22 11/16" (27x570x577)



H100537 | SCREW PFH SD
(x7) | 8x1

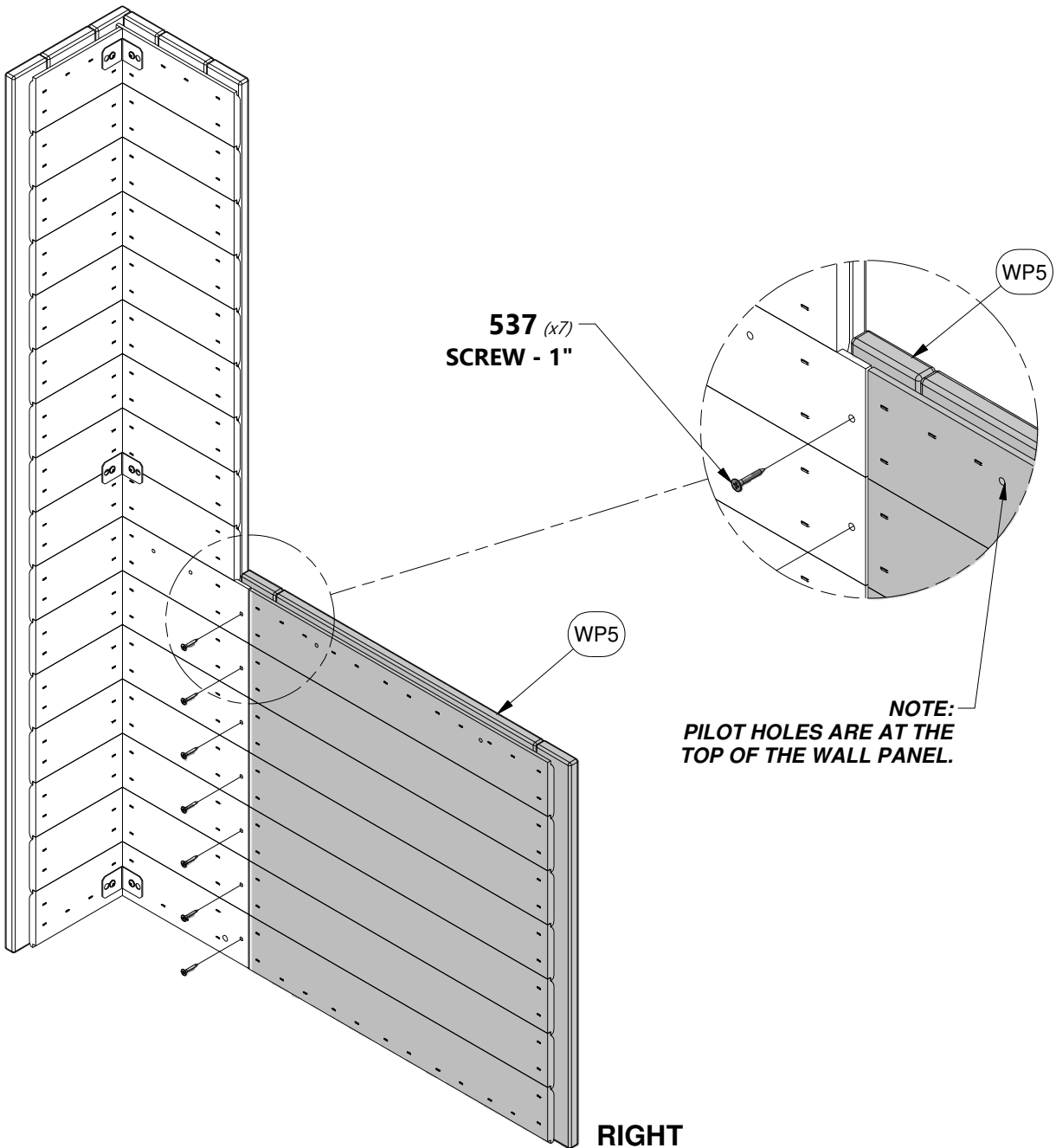

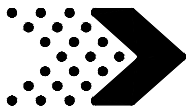

Phase 1

STEP 3



WP2 | WALL PANEL - W2A02642
(x1) | 1 1/16" x 22 11/16" x 48 13/16" (27x577x1240)



H100537 | SCREW PFH SD
(x7) | 8x1

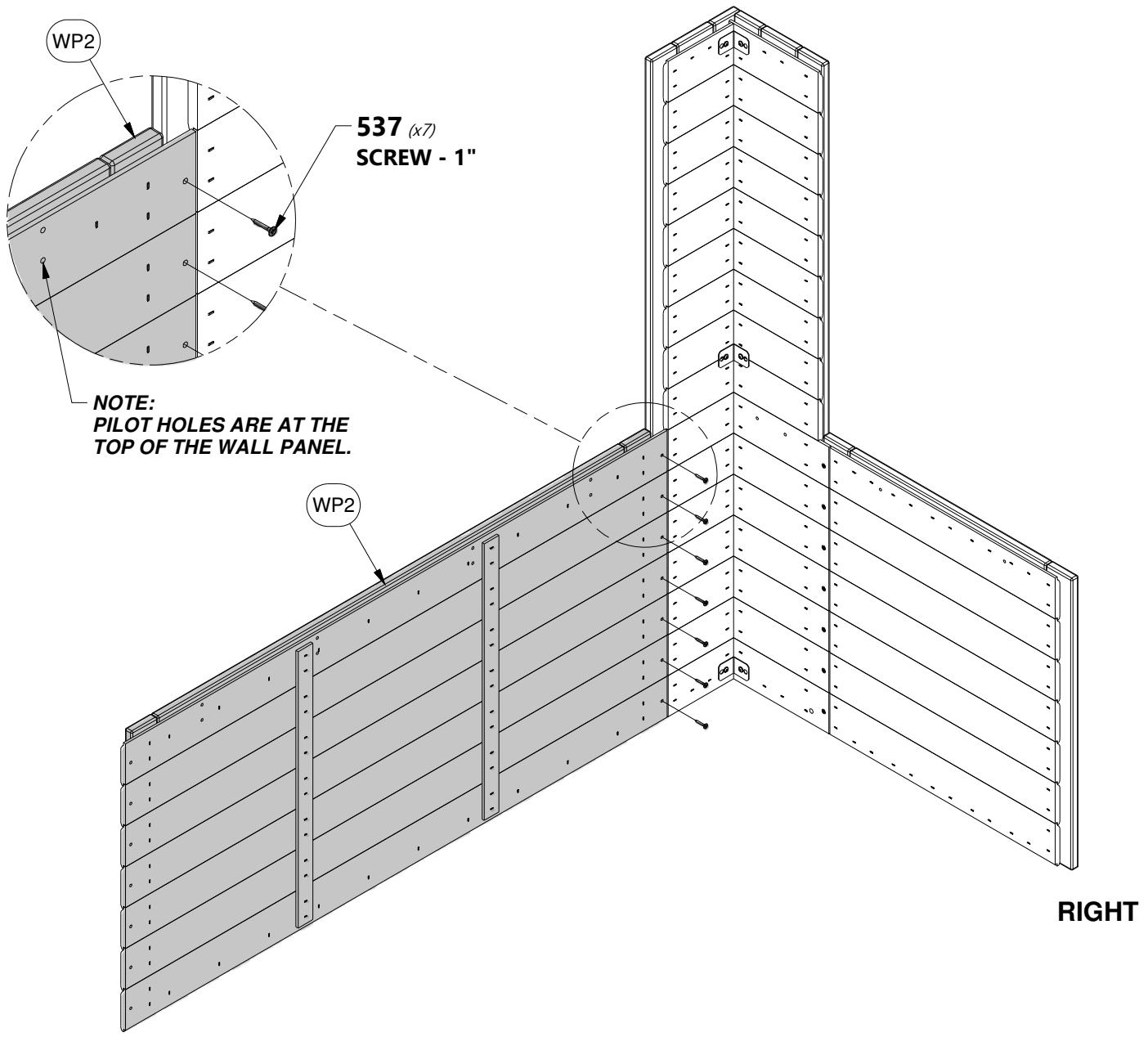

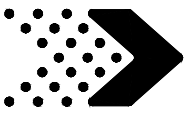

Phase 1

STEP 4

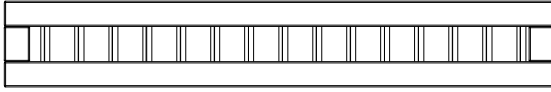

WP1 | WALL PANEL - W2A02216
(x1) | 1 1/16"x8 1/16"x51 9/16" (27x204x1310)



H100537 | SCREW PFH SD
(x7) | 8x1

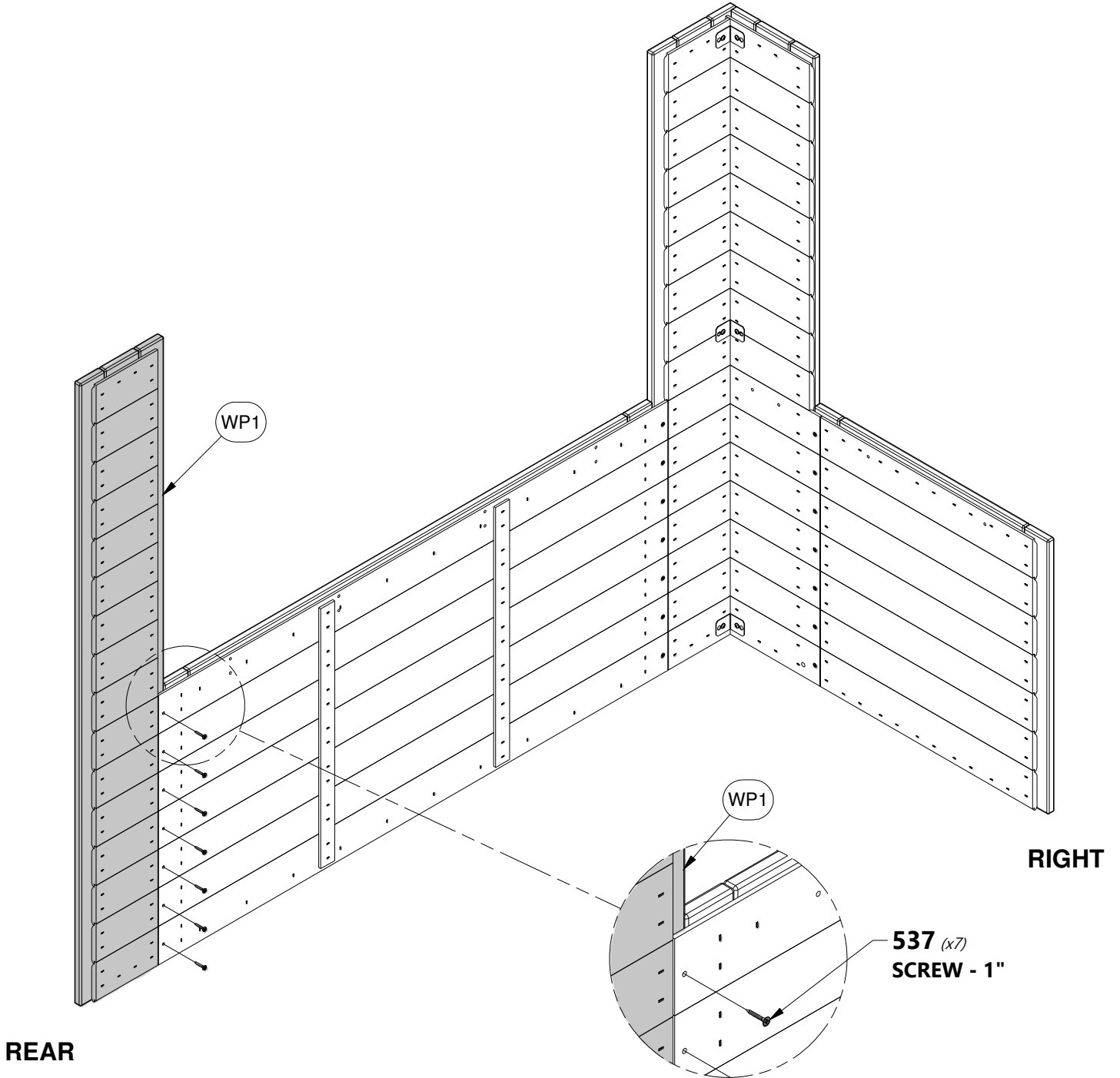

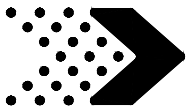

Phase 1

STEP 5



WP3 | WALL PANEL - W2A02218
(x1) | 1 1/16" x 9" x 51 9/16" (27 x 229 x 1310)

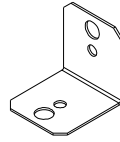

A4M00555 | 90° L-BRACKET - BLK
(x3)



H100392 | SCREW PWH BLK
(x6) | 8 x 3/4"

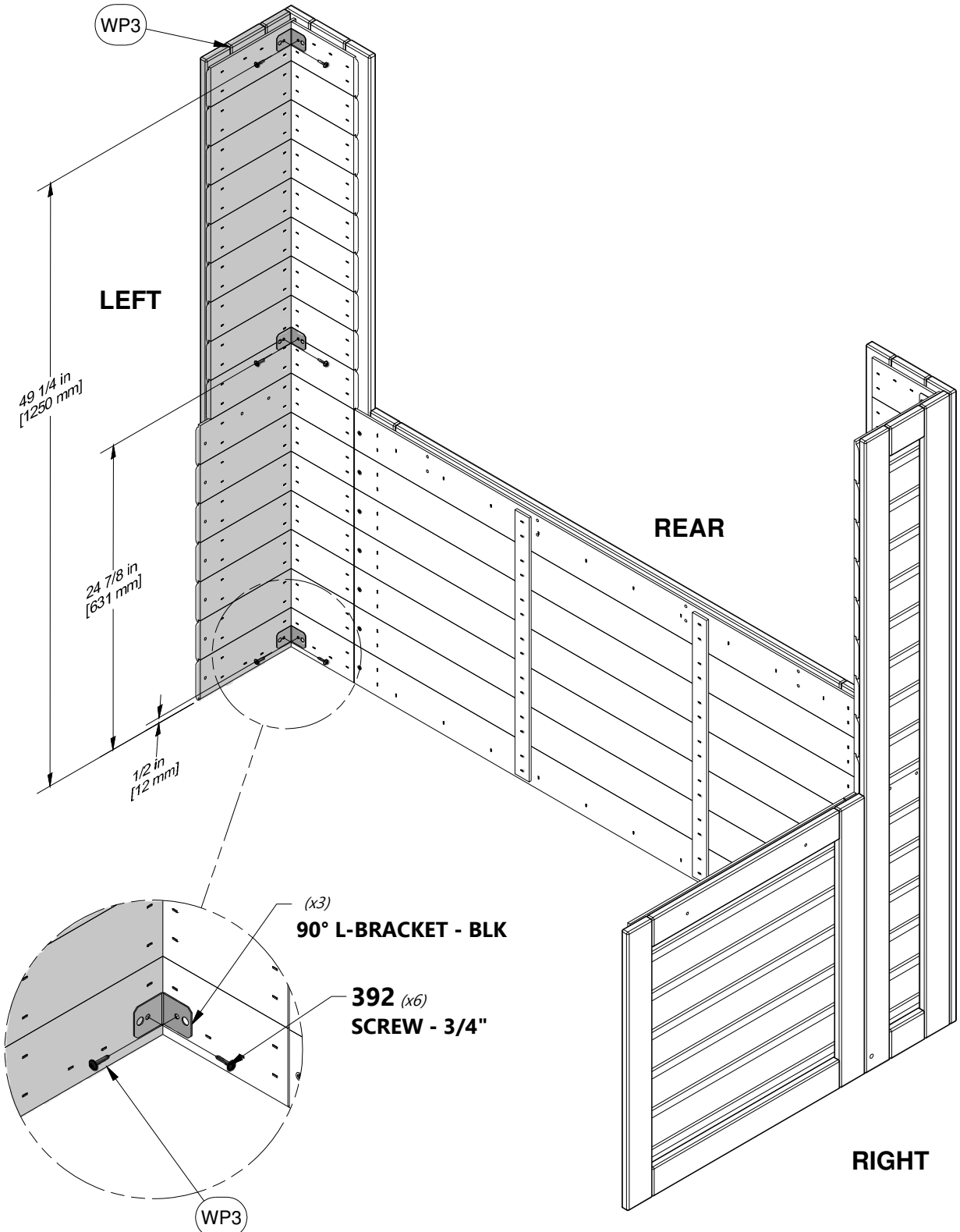

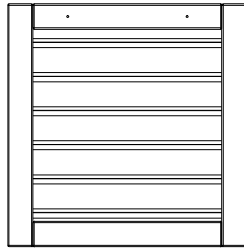
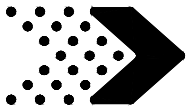

WP5 | WALL PANEL - W2A02220
(x1) 1 1/16"x22 7/16"x22 11/16" (27x570x577)



H100537 | SCREW PFH SD
(x7) 8x1

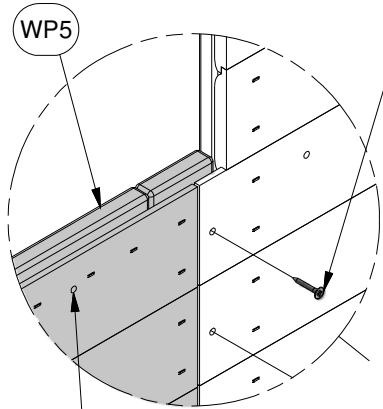

537 (x7)
SCREW - 1"

NOTE:
PILOT HOLES ARE AT THE
TOP OF THE WALL PANEL.

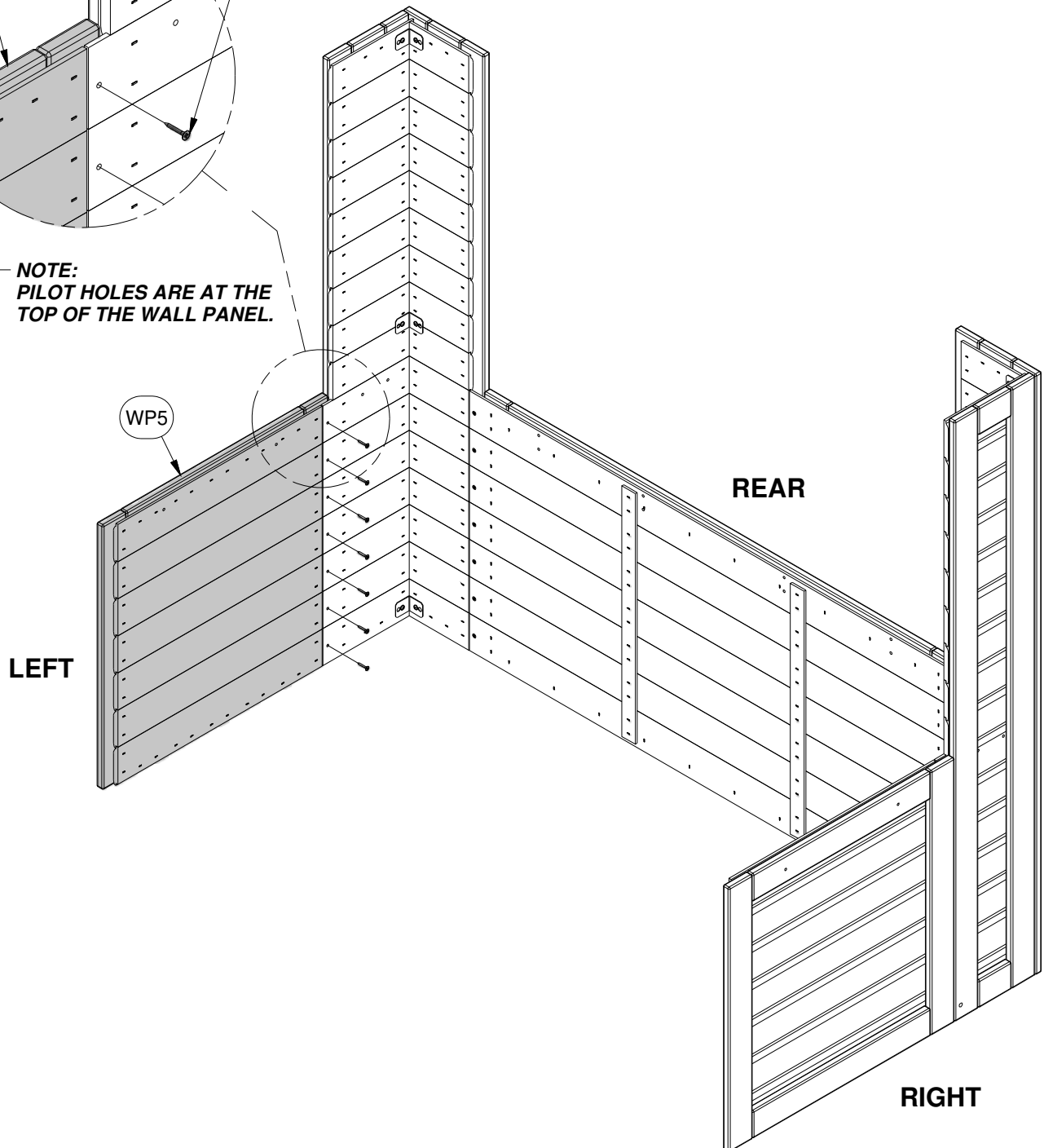

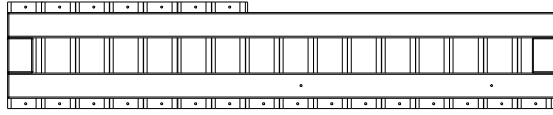
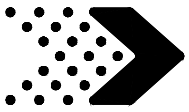

WP6 | WALL PANEL - W2A02528
(x1) | 1 1/16"x10"x51 9/16" (27x254x1310)



H100537 | SCREW PFH SD
(x7) | 8x1

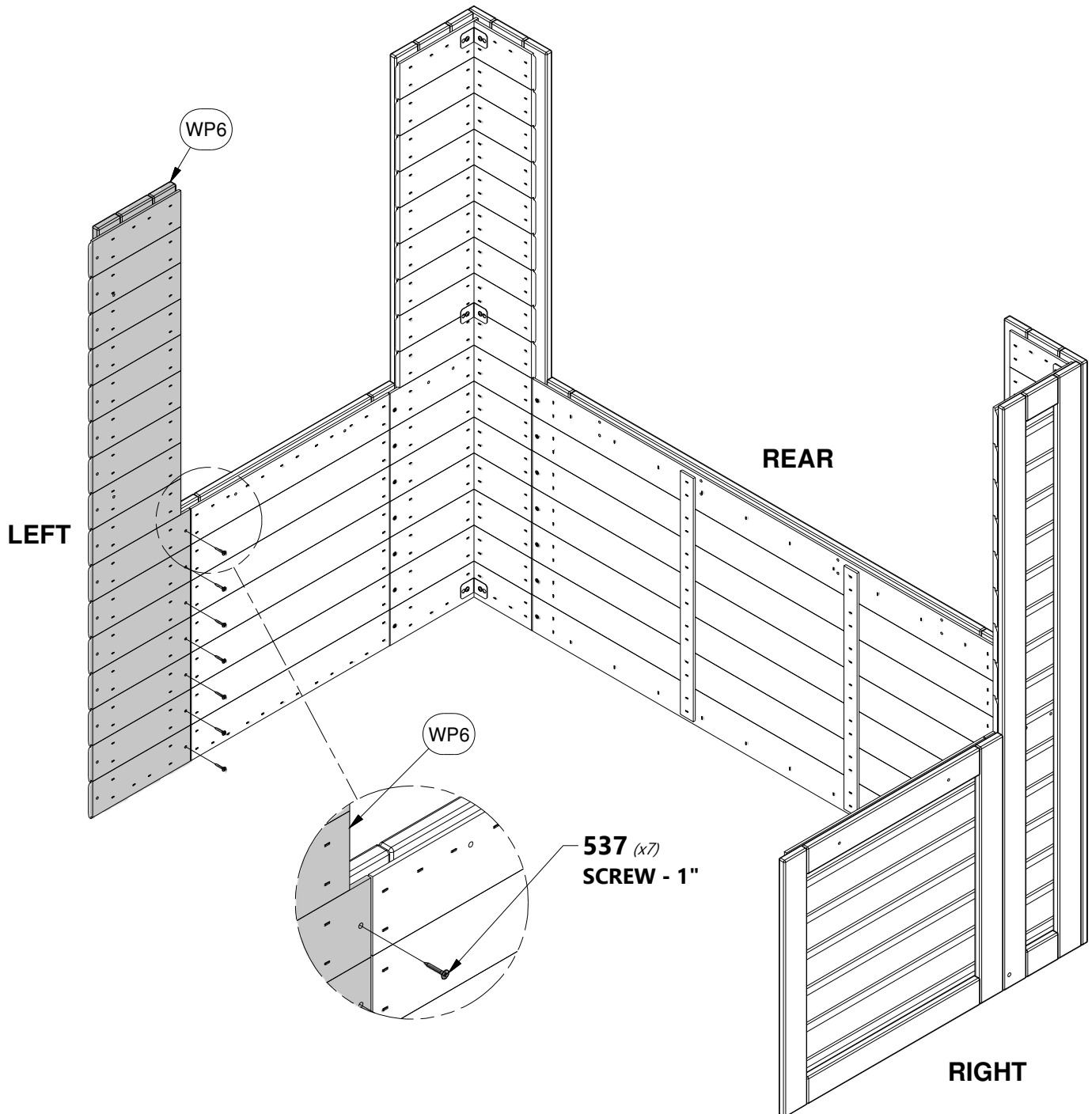

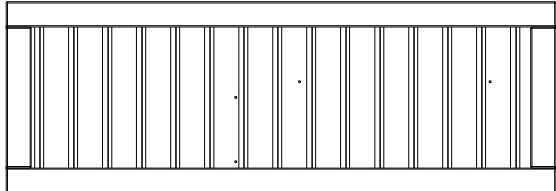
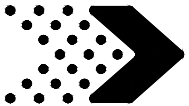

WP7 | WALL PANEL - W2A02529
(x1) | 1 1/16"x17 15/16"x51 9/16" (27x455x1310)



H100537 | SCREW PFH SD
(x16) | 8x1

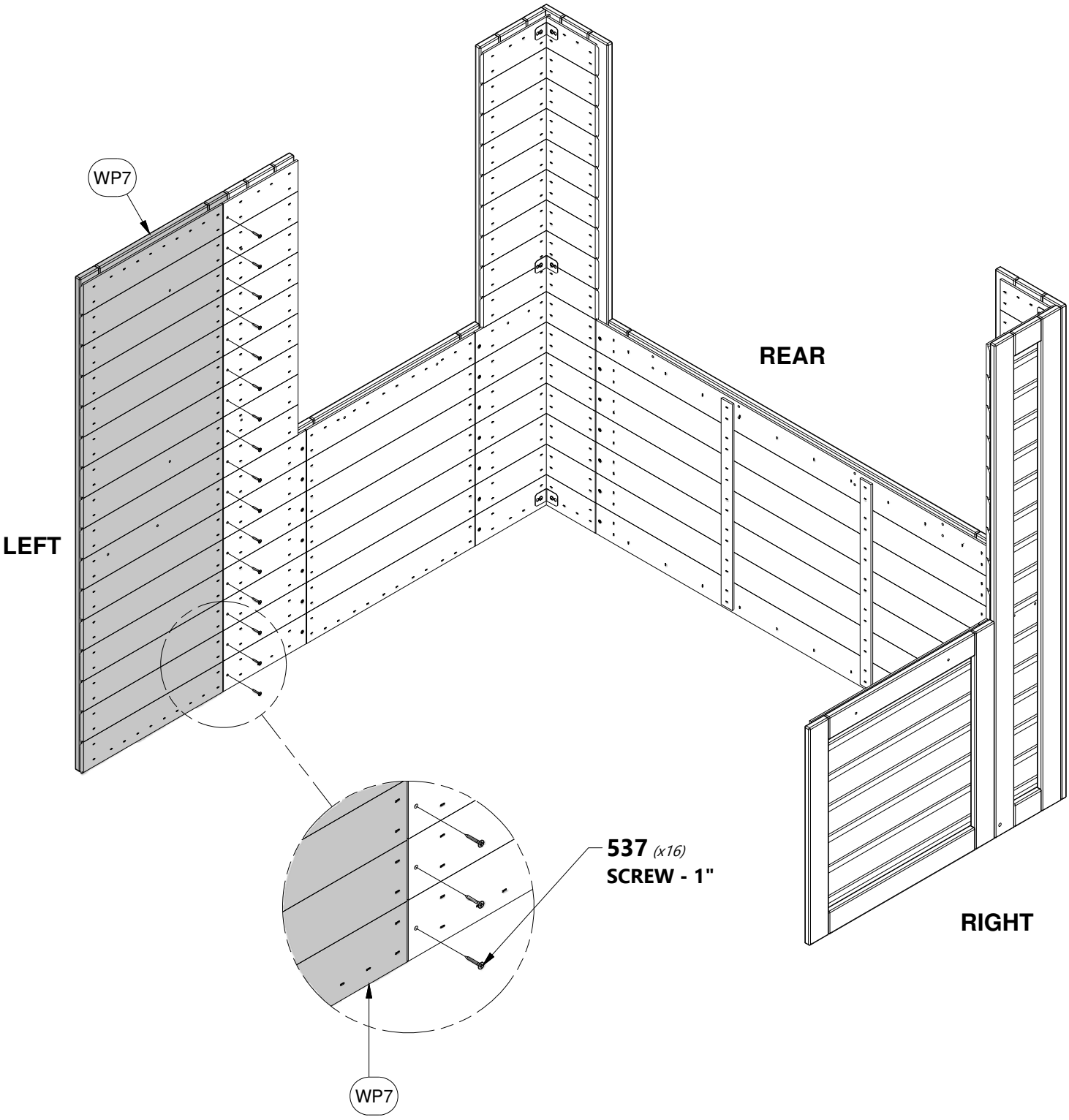

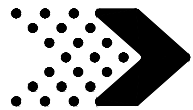

Phase 1

STEP 9

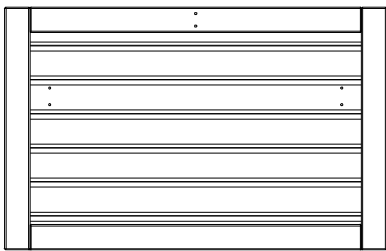

WP8 | WALL PANEL - W2A02643
(x1) | 1 1/16"x22 11/16"x35 13/16" (27x577x910)

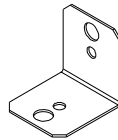

A4M00555 | 90° L-BRACKET - BLK
(x2)



H100392 | SCREW PWH BLK
(x4) | 8x3/4

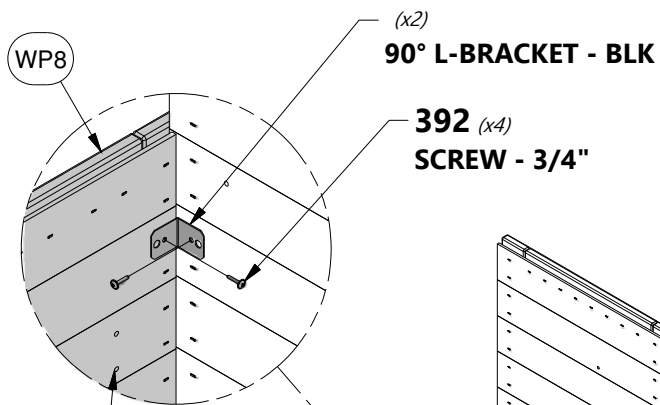

NOTE:
PILOT HOLES ARE AT THE TOP OF THE WALL PANEL.

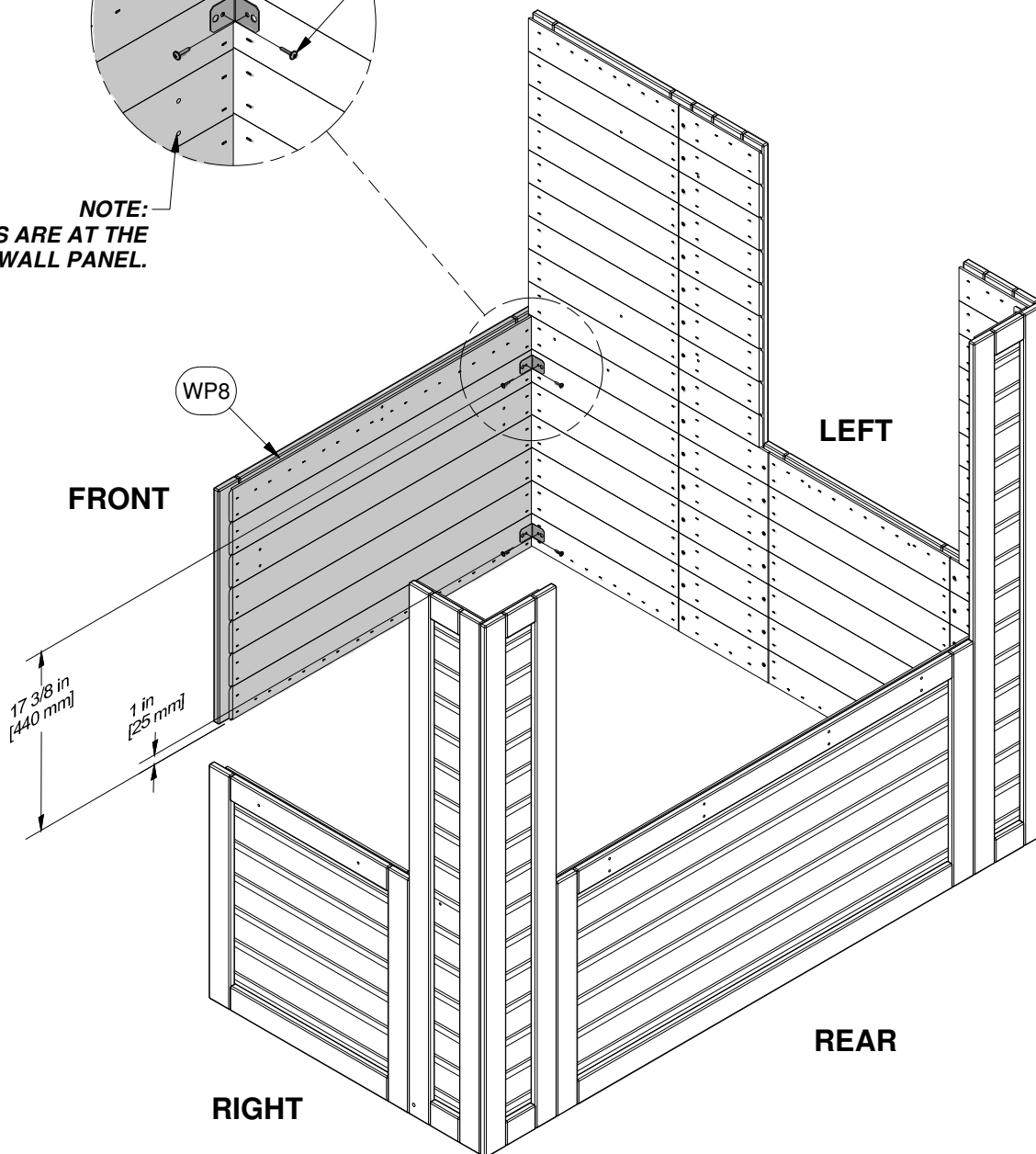

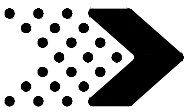

Phase 1

STEP 10

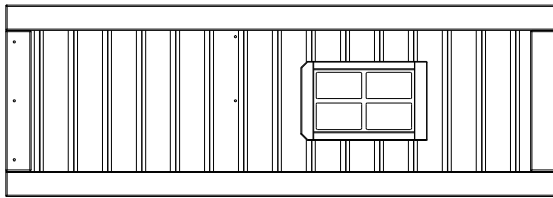

WP10 | WALL PANEL - W2A02532
(x1) | 1 1/16"x17 15/16"x51 9/16" (27x455x1310)

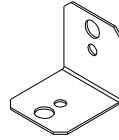

A4M00555 | 90° L-BRACKET - BLK
(x2)



H100392 | SCREW PWH BLK
(x4) | 8x3/4

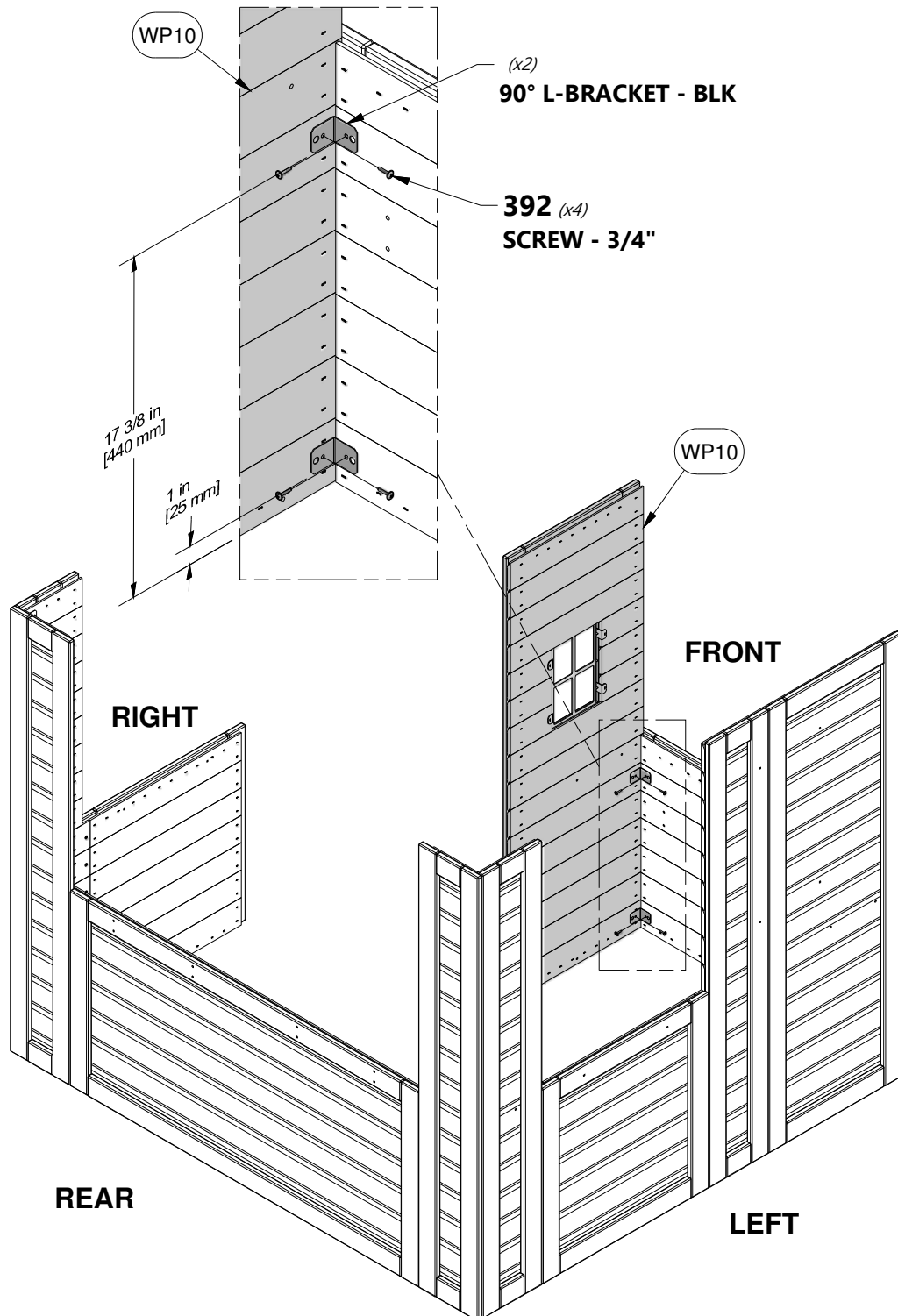

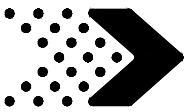

Phase 1

STEP 11

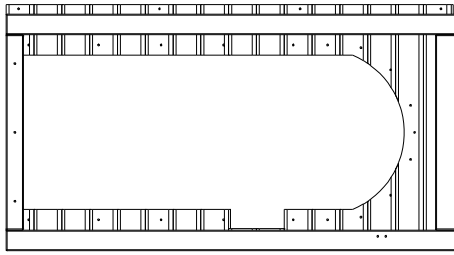

WP11 | WALL PANEL - W2A02533
(x1) | 1 1/16"x28 1/8"x51 9/16" (27x715x1310)



H100538 | SCREW PFH SD
(x4) | 8x1 1/2

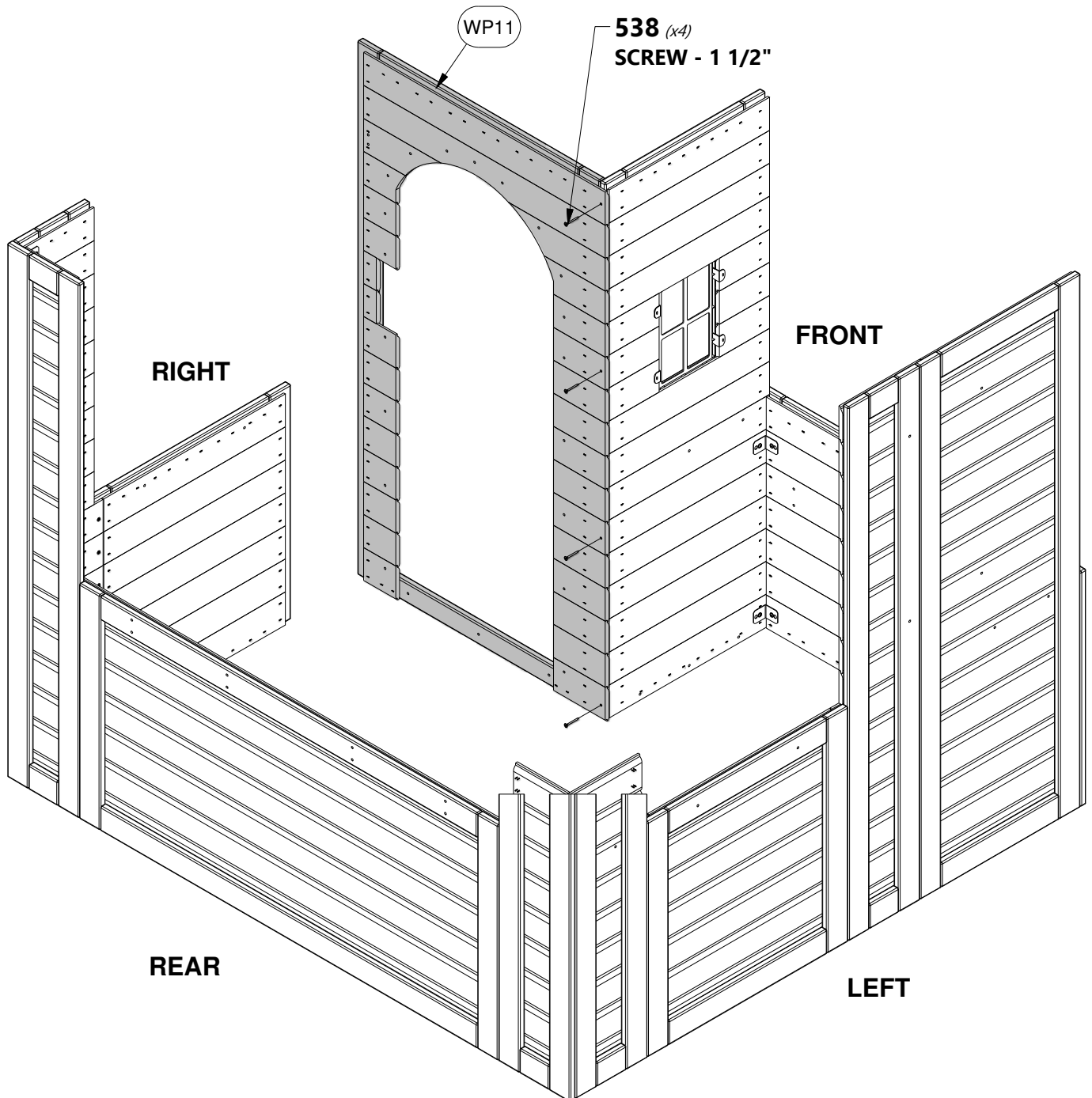

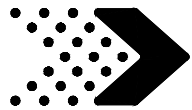

Phase 1

STEP 12



WP12 | WALL PANEL - W2A02539
(x1) 1 1/16"x9"x51 9/16" (27x229x1310)

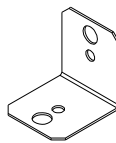

A4M00555 | 90° L-BRACKET - BLK
(x3)



H100537 | SCREW PFH SD
(x7) 8x1



H100392 | SCREW PWH BLK
(x6) 8x3/4

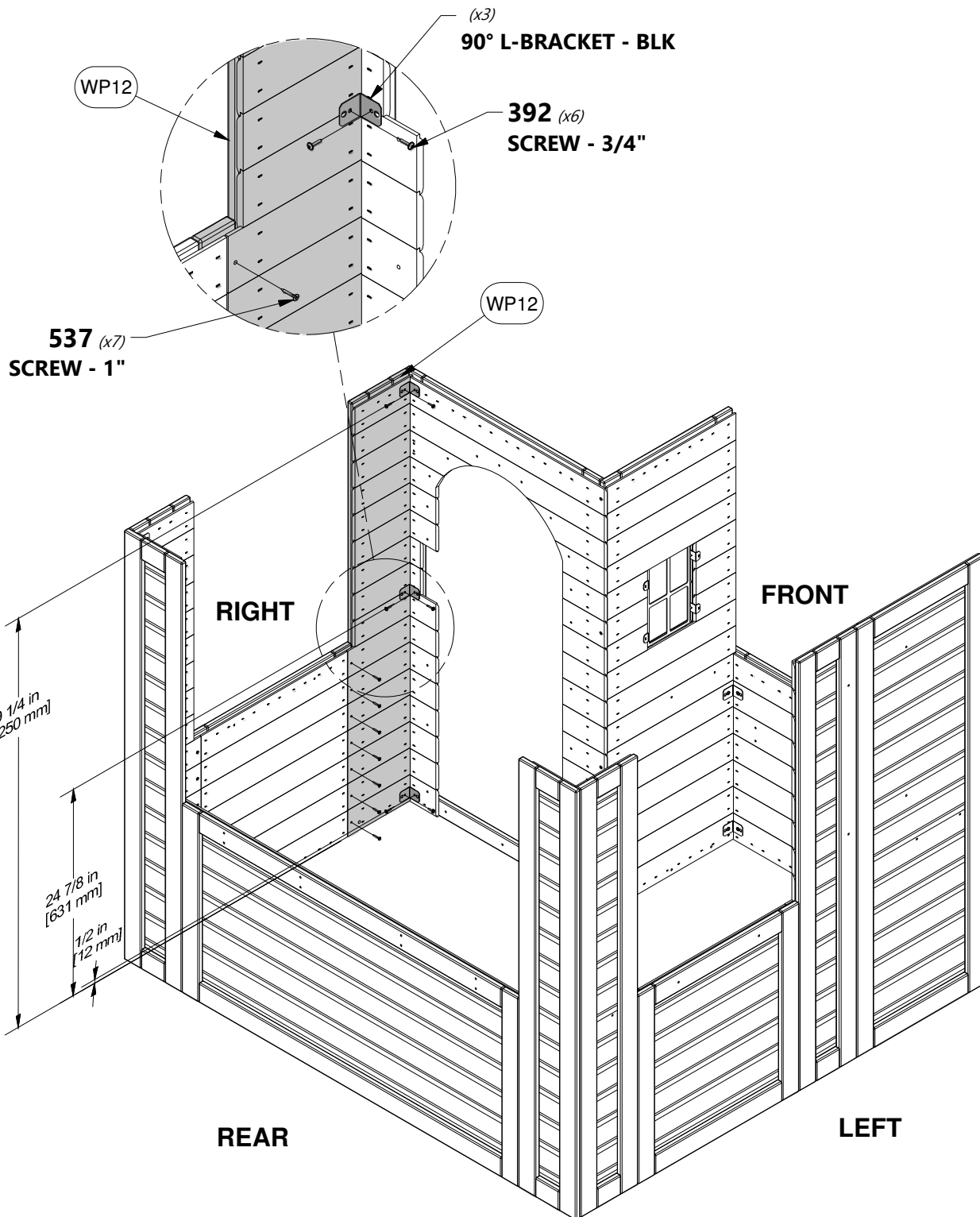

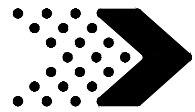

Phase 2

STEP 1



J5 | SUPPORT - W4L12657
(x2) | 15/16"x2 3/8"x10 3/16" (24x60x258)



H100541 | SCREW PFH SD
(x2) | 8x1 3/4



H100539 | SCREW PFH SD
(x4) | 8x1 1/4

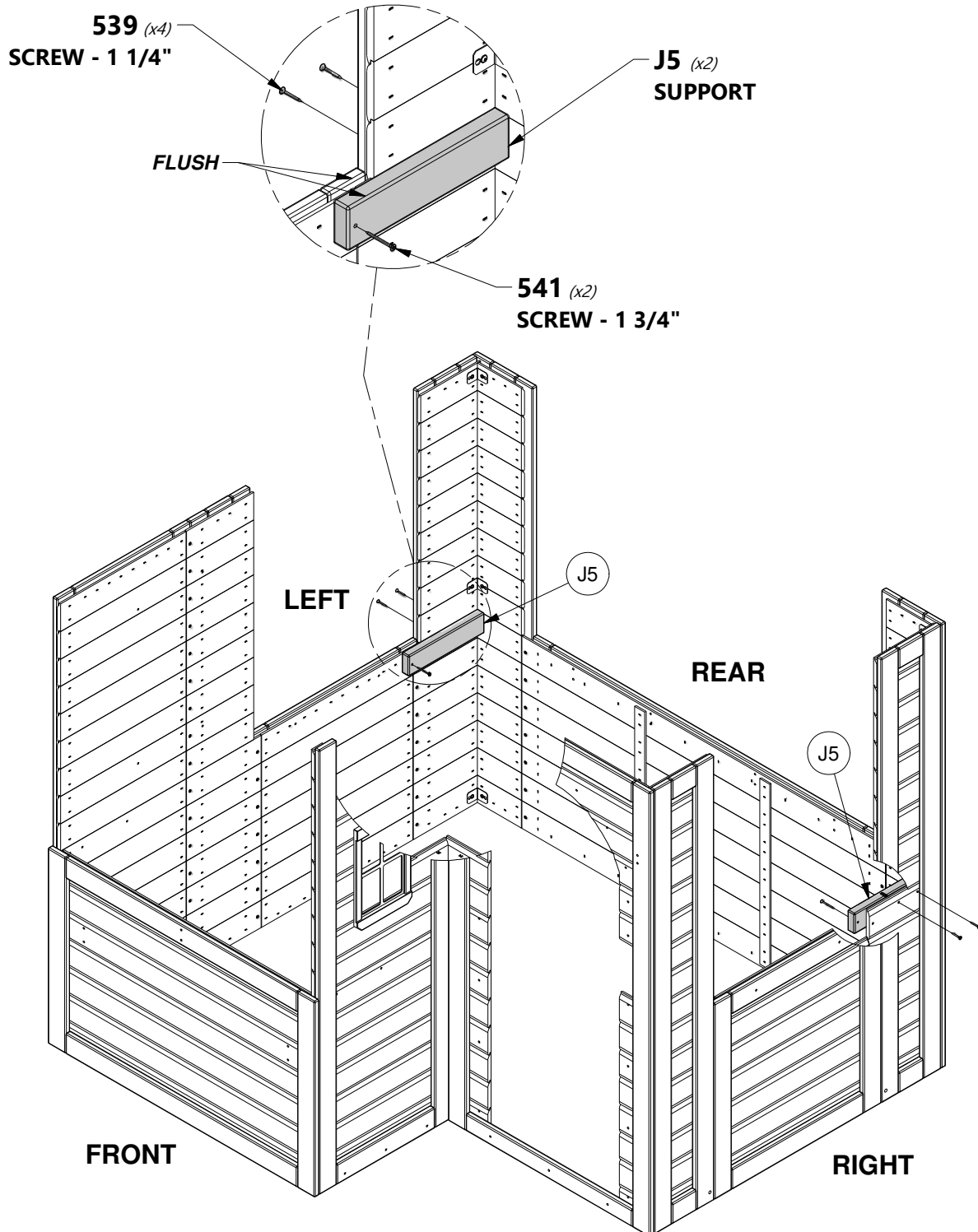

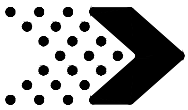

Phase 2

STEP 2



J4 | SUPPORT - W4L08979
(x2) | 15/16"x2 3/8"x10 1/8" (24x60x257)



H100539 | SCREW PFH SD
(x4) | 8x1 1/4

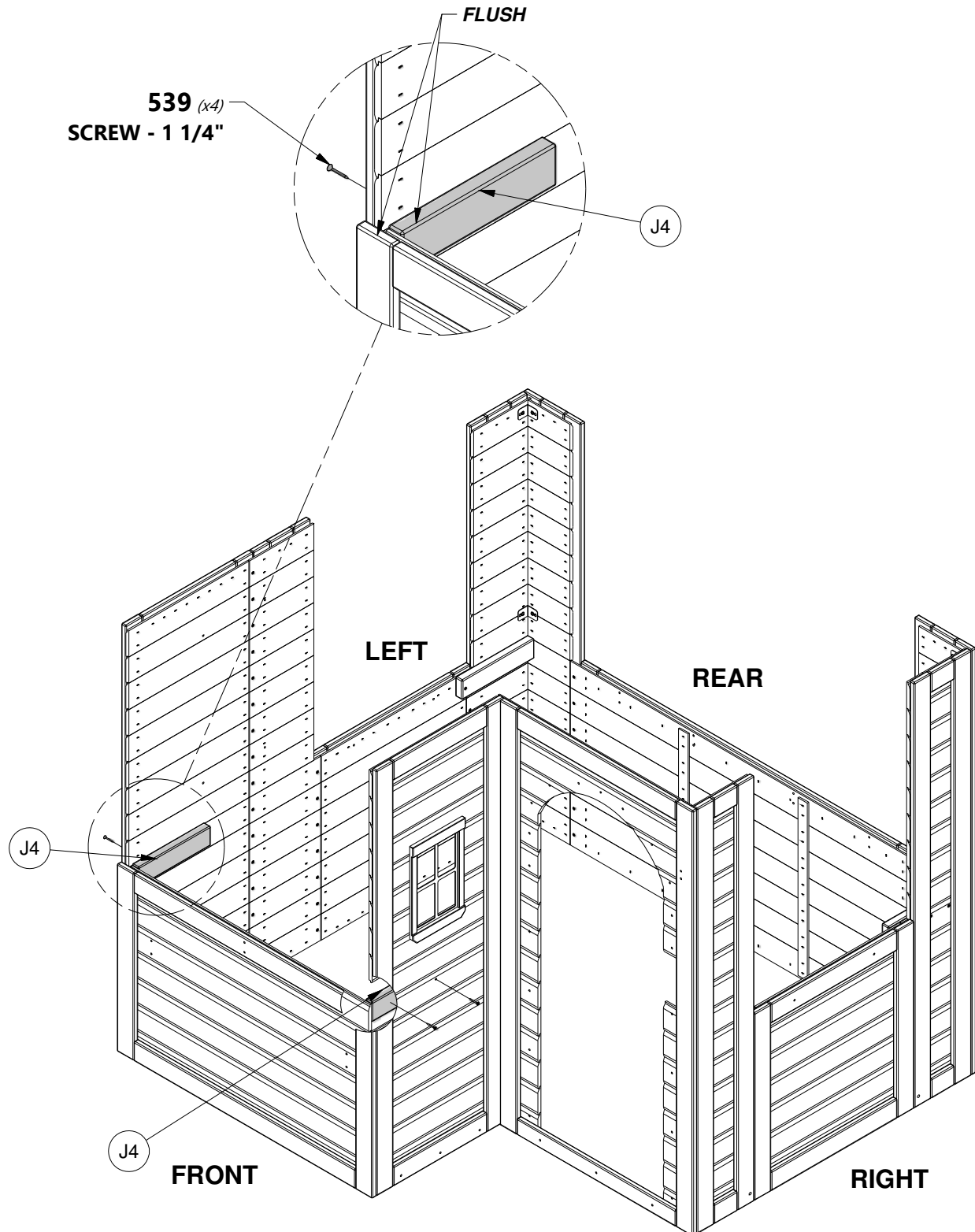

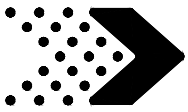

Phase 2

STEP 3

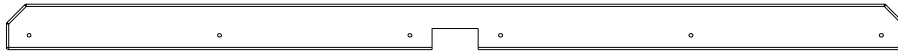

N2 | WINDOW TRIM - W4L08947
(x1) | 5/8"x2 3/8"x46 3/4" (16x60x1188)



H100538 | SCREW PFH SD
(x6) | 8x1 1/2

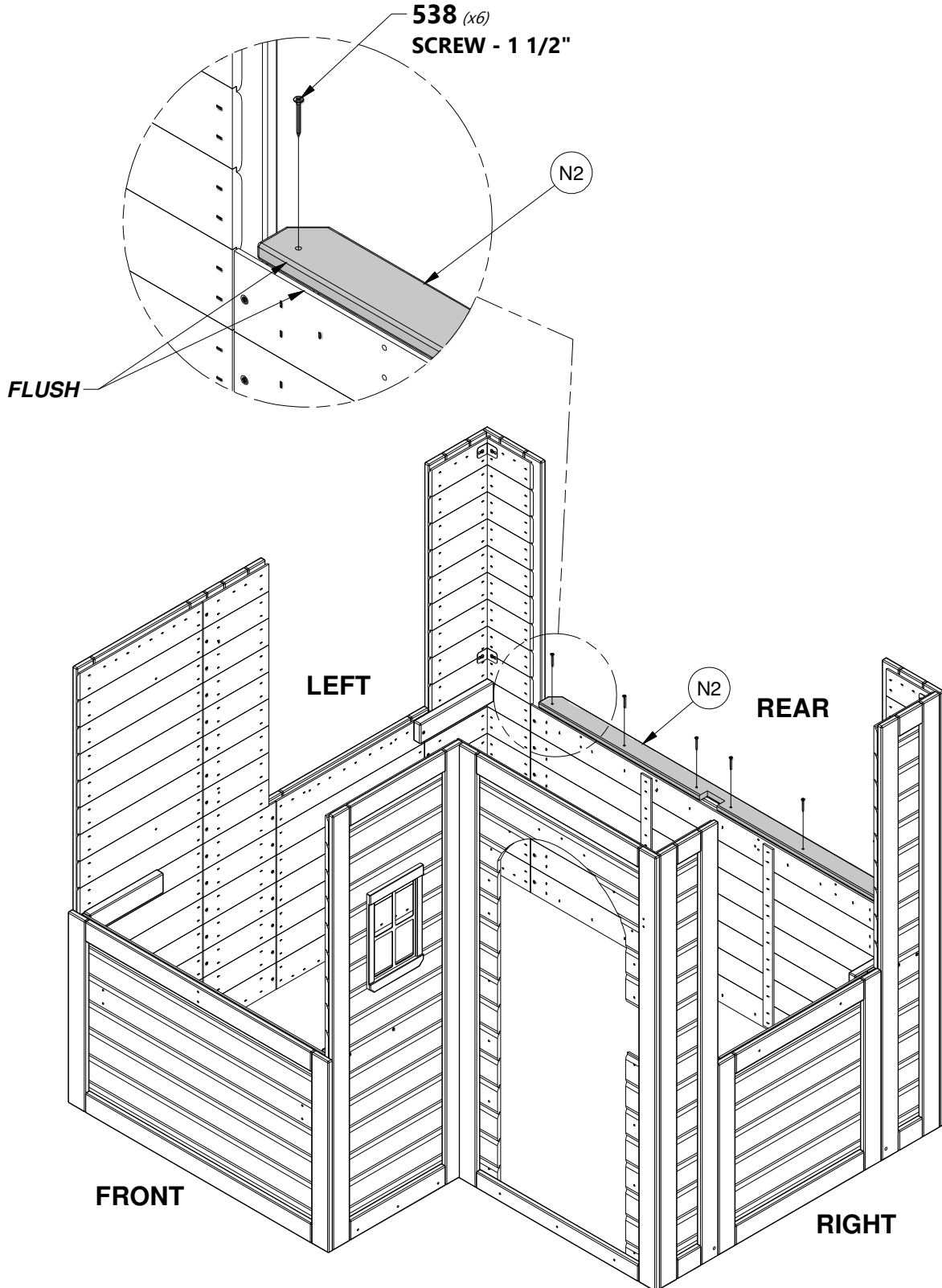

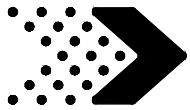

Phase 2

STEP 4



H9 | SUPPORT - W4L12658
(x3) | 15/16"x3 3/8"x9 13/16" (24x86x250)



E1 | SUPPORT - W4L12669
(x1) | 1 7/16"x3 3/8"x9 13/16" (36x86x250)



H100542 | SCREW PFH SD
(x8) | 8x2

**HOLD BOARDS DOWN 5/8 in [16mm]
FROM TOP OF N2 BOARD.**

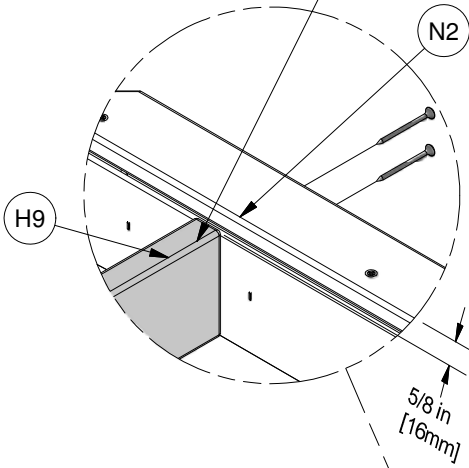

**NOTE:
CENTER H9 & E1 BOARDS WITH
PILOT HOLES IN WALL PANEL.**

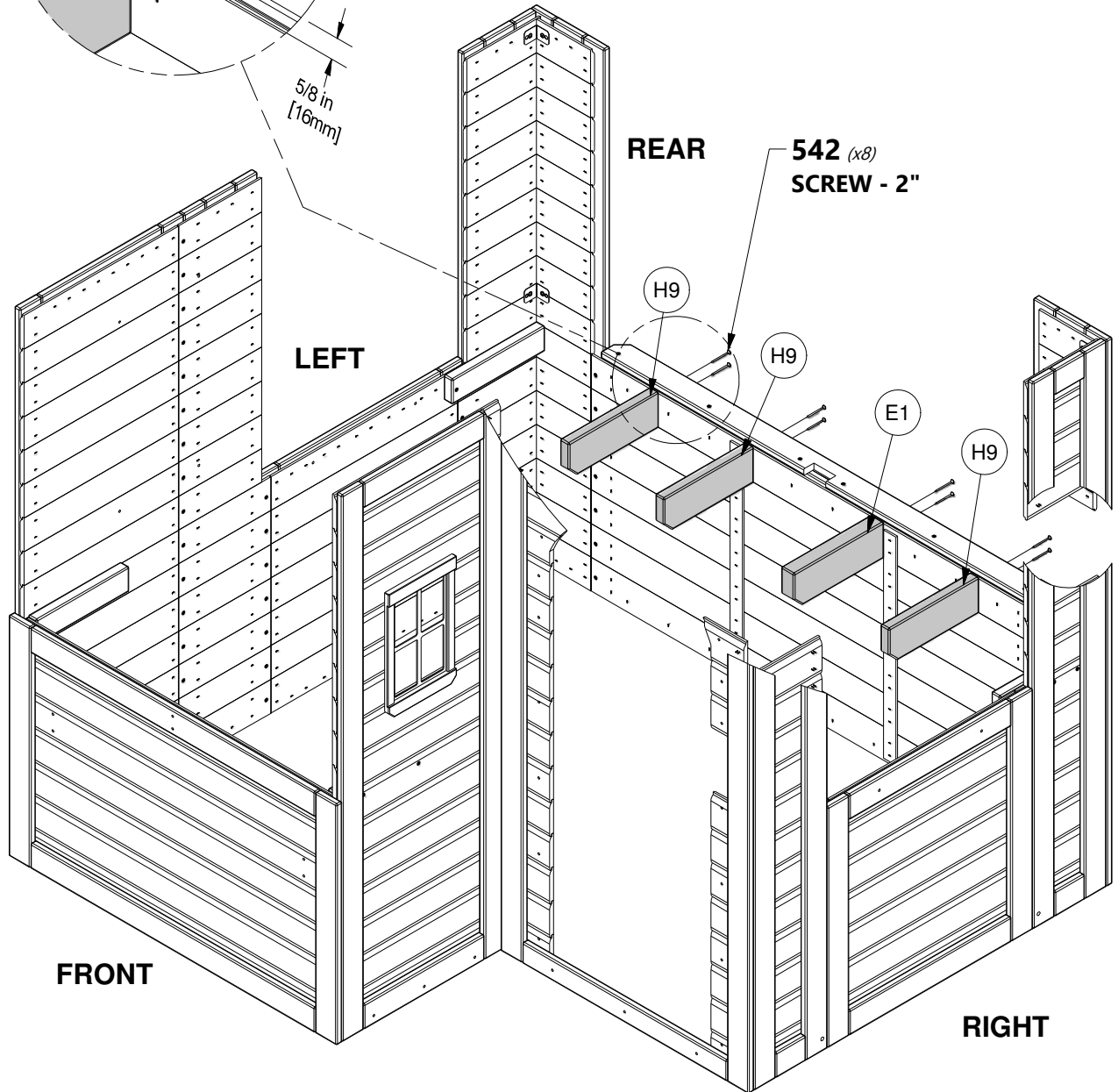

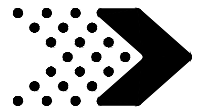

Phase 2

STEP 5

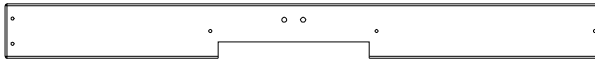

M2 | SHELF - W4L11796
(x1) | 5/8"x3 3/8"x37 1/4" (16x86x946)



M16 | SHELF - W4L12670
(x1) | 5/8"x3 3/8"x23 7/16" (16x86x596)



H100538 | SCREW PFH SD
(x9) | 8x1 1/2

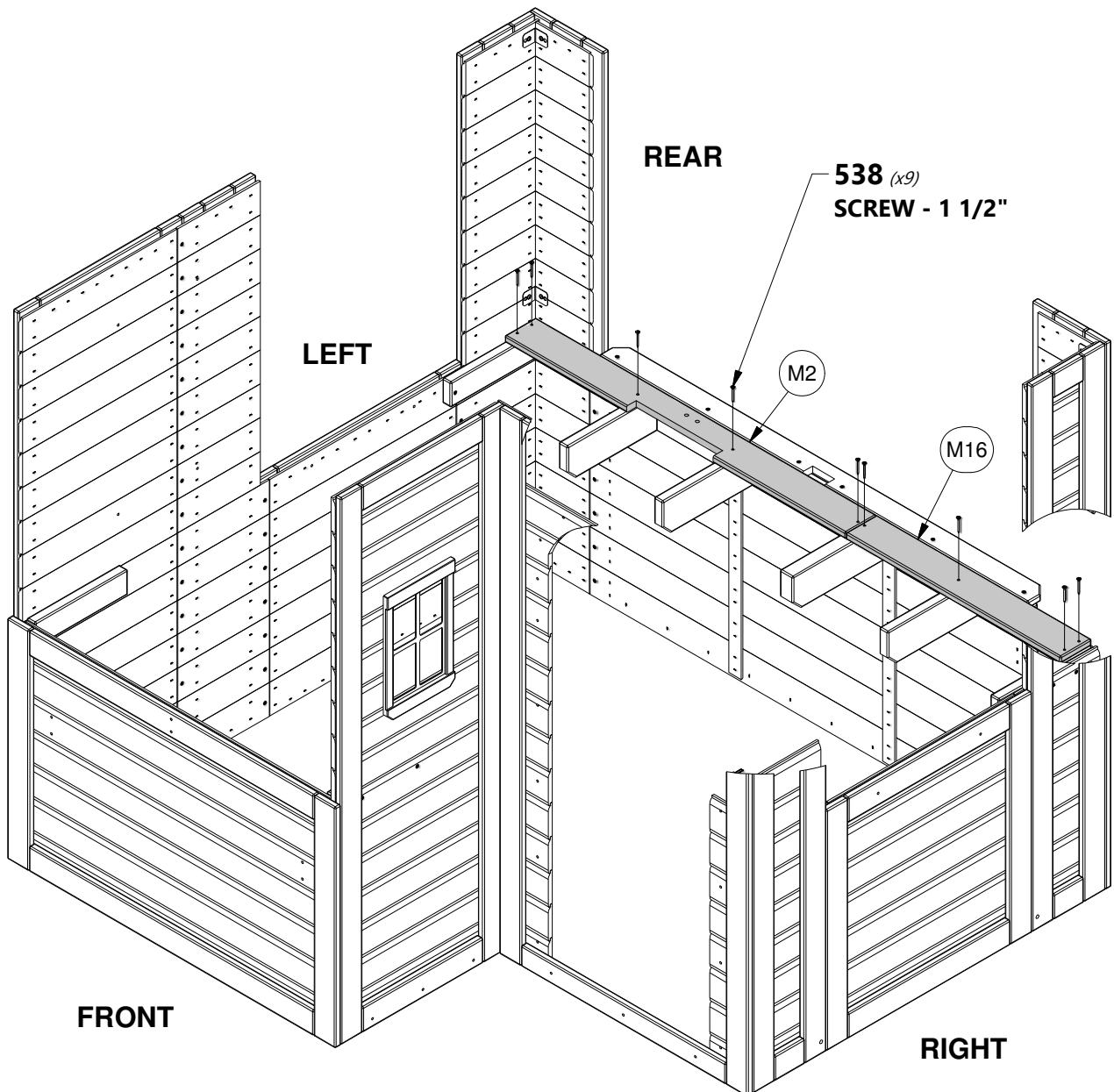

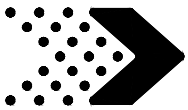

Phase 2

STEP 6

M10 | SHELF - W4L11798
 (x1) | 5/8"x3 3/8"x13 5/16" (16x86x339)

M11 | SHELF - W4L11799
 (x1) | 5/8"x3 3/8"x37 15/16" (16x86x964)

M9 | SHELF - W4L11797
 (x1) | 5/8"x3 3/8"x37 1/4" (16x86x946)

M16 | SHELF - W4L12670
 (x1) | 5/8"x3 3/8"x23 7/16" (16x86x596)

H100538 | SCREW PFH SD
 (x17) | 8x1 1/2

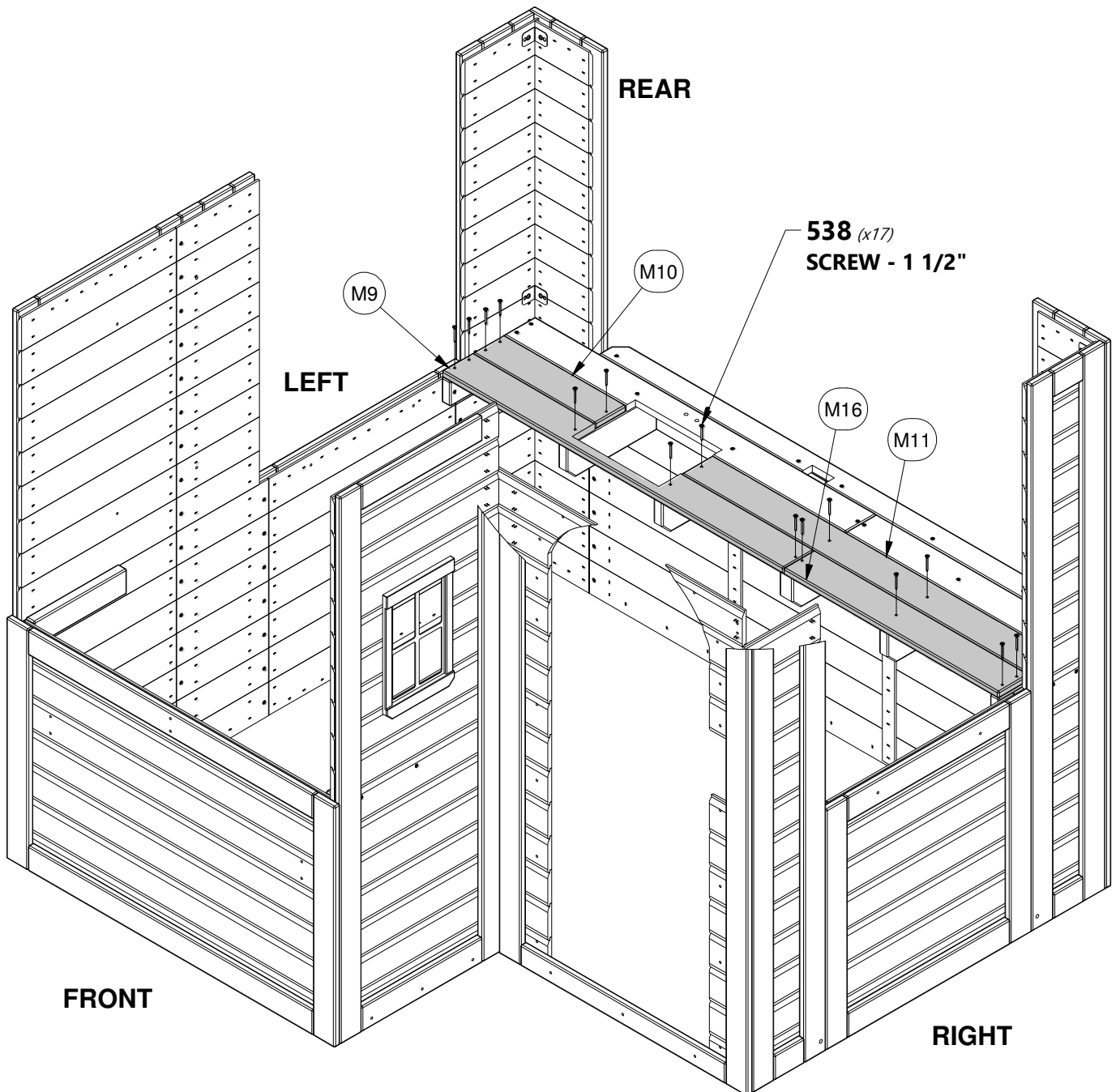

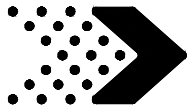

Phase 2

STEP 7



H10 | FLOWER BOX - W4L11674
(x1) | 15/16"x3 3/8"x26 7/16" (24x86x672)



J7 | FLOWER BOX - W4L08989
(x1) | 15/16"x2 3/8"x26 7/16" (24x60x672)



M5 | FLOWER BOX - W4L11675
(x1) | 5/8"x3 3/8"x28 3/8" (16x86x720)



H11 | FLOWER BOX - W4L08988
(x2) | 15/16"x3 3/8"x6 9/16" (24x86x166)



H100542 | SCREW PFH SD
(x8) | 8x2



H100541 | SCREW PFH SD
(x4) | 8x1 3/4



H100538 | SCREW PFH SD
(x4) | 8x1 1/2

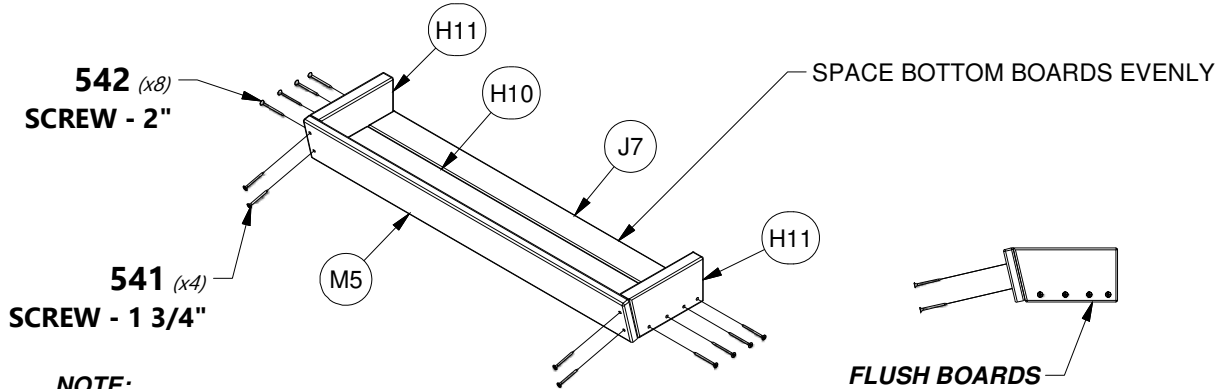

NOTE:
BUILD FLOWER BOX FIRST.

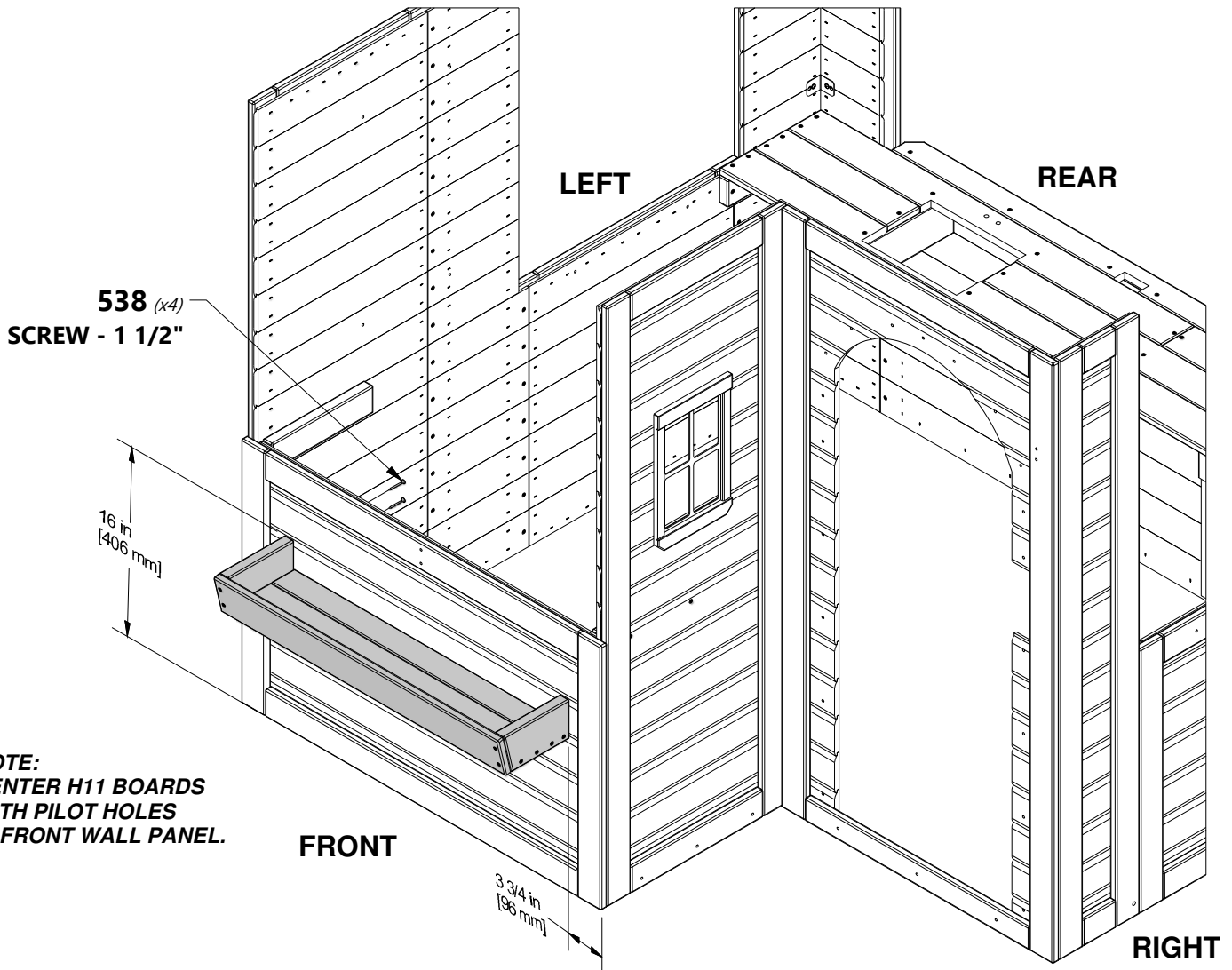

NOTE:
CENTER H11 BOARDS
WITH PILOT HOLES
IN FRONT WALL PANEL.

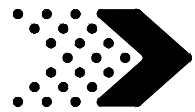

Phase 2

STEP 8



K2 | SHELF - W4L12660
(x2) | 5/8"x5 1/4"x33 11/16" (16x134x856)



H9 | SUPPORT - W4L12658
(x1) | 15/16"x3 3/8"x9 13/16" (24x86x250)



H100542 | SCREW PFH SD
(x2) | 8x2



H100538 | SCREW PFH SD
(x10) | 8x1 1/2

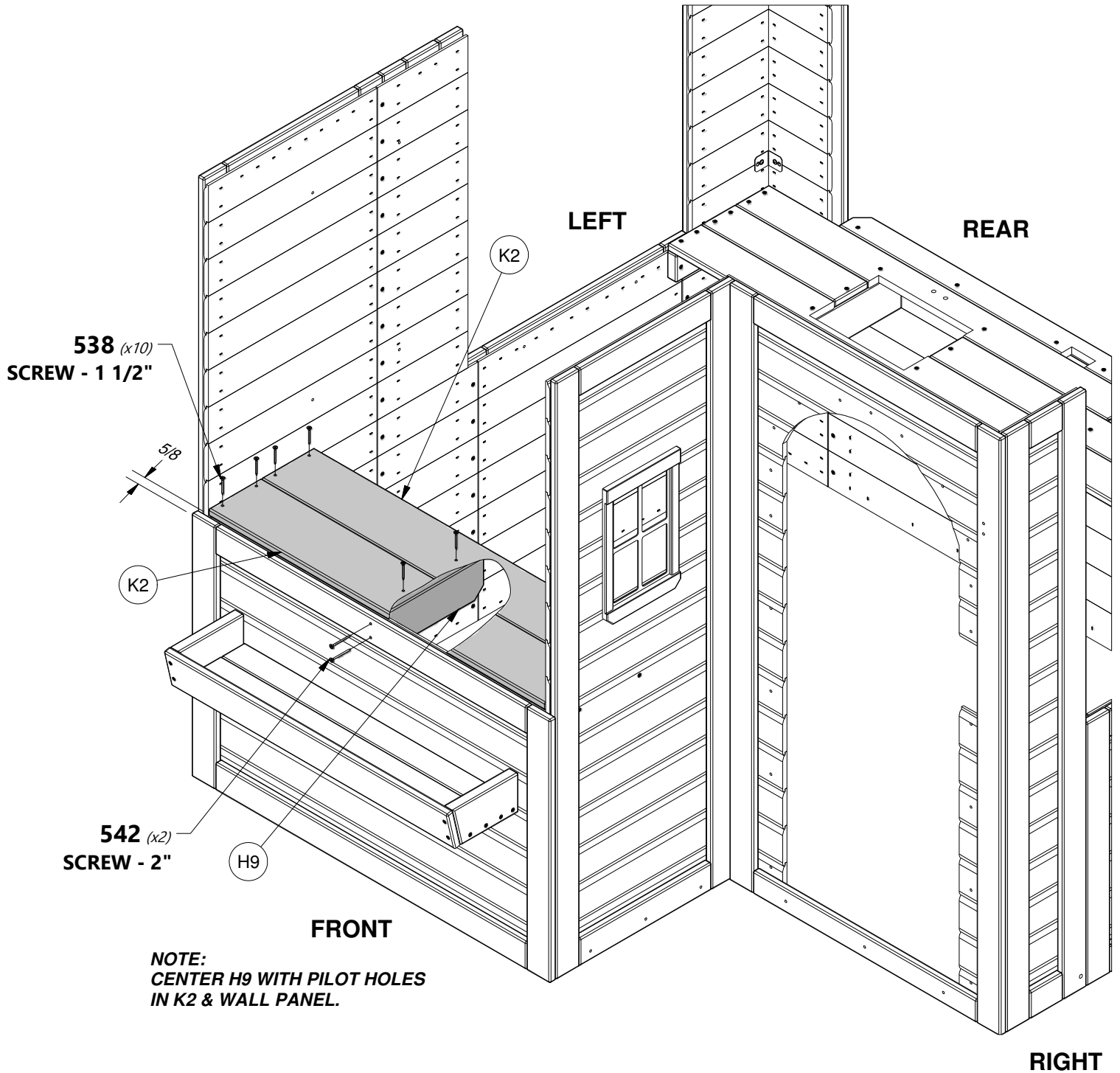

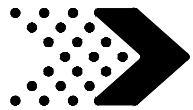

Phase 2

STEP 9



CHALKBOARD - A4M00934
(x1) | 1"x2 3/8"x11" (24x60x280)



H100541 | SCREW PFH SD
(x2) | 8x1 3/4



H100539 | SCREW PFH SD
(x2) | 8x1 1/4

NOTE:
ALIGN PILOT HOLES IN BACK OF CHALKBOARD
WITH PILOT HOLES IN WALL PANEL AND
ATTACH FROM OUTSIDE.

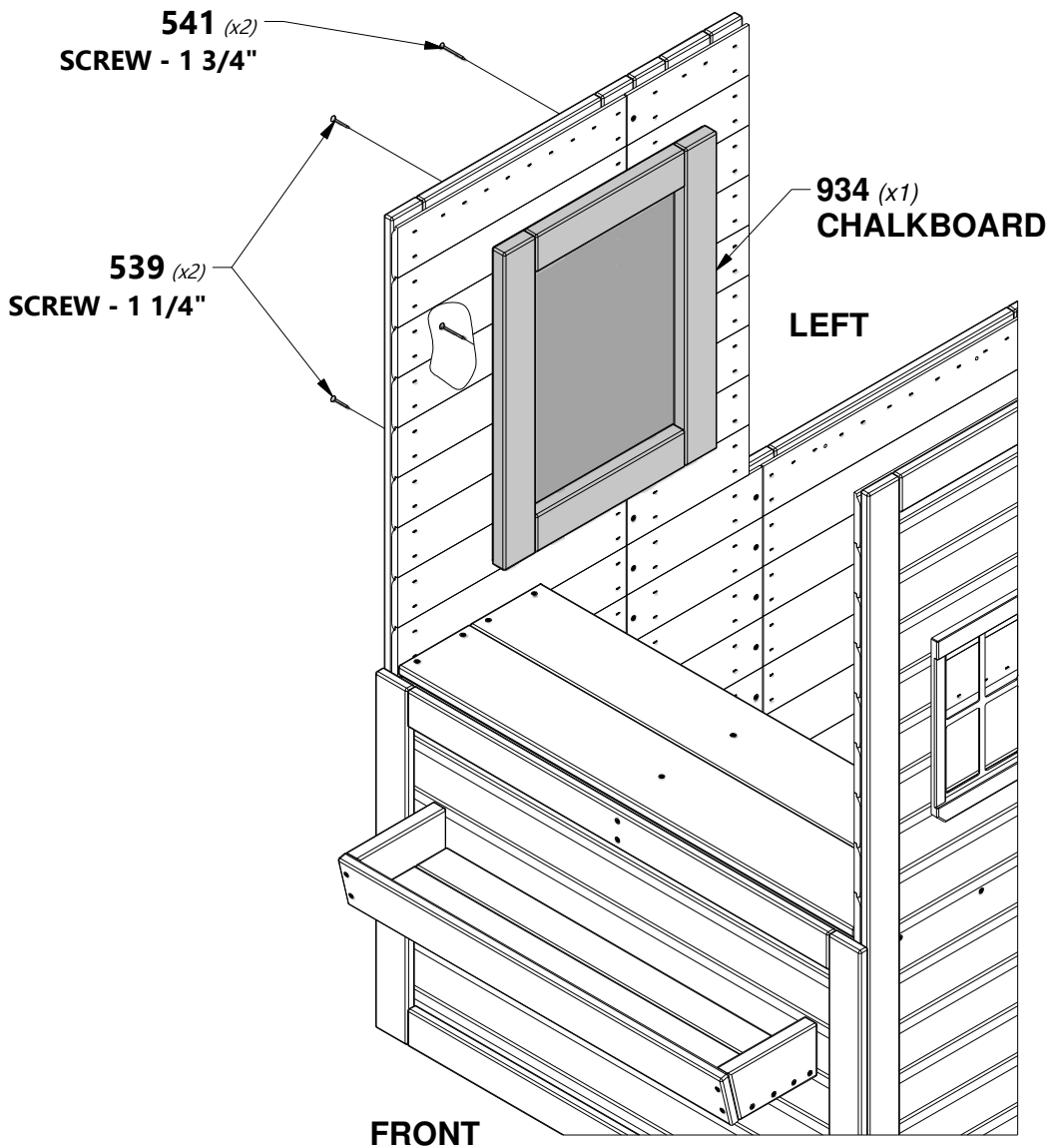
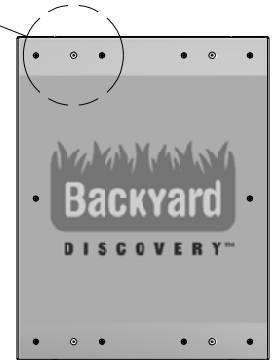
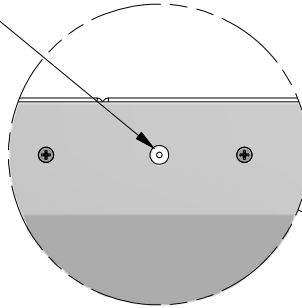

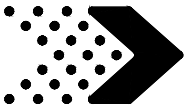

Phase 2

STEP 10

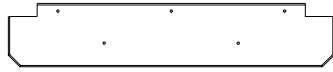

K1 | WINDOW TRIM - W4L08948
(x1) | 5/8"x5 1/4"x27 3/16" (16x134x690)



H100538 | SCREW PFH SD
(x3) | 8x1 1/2

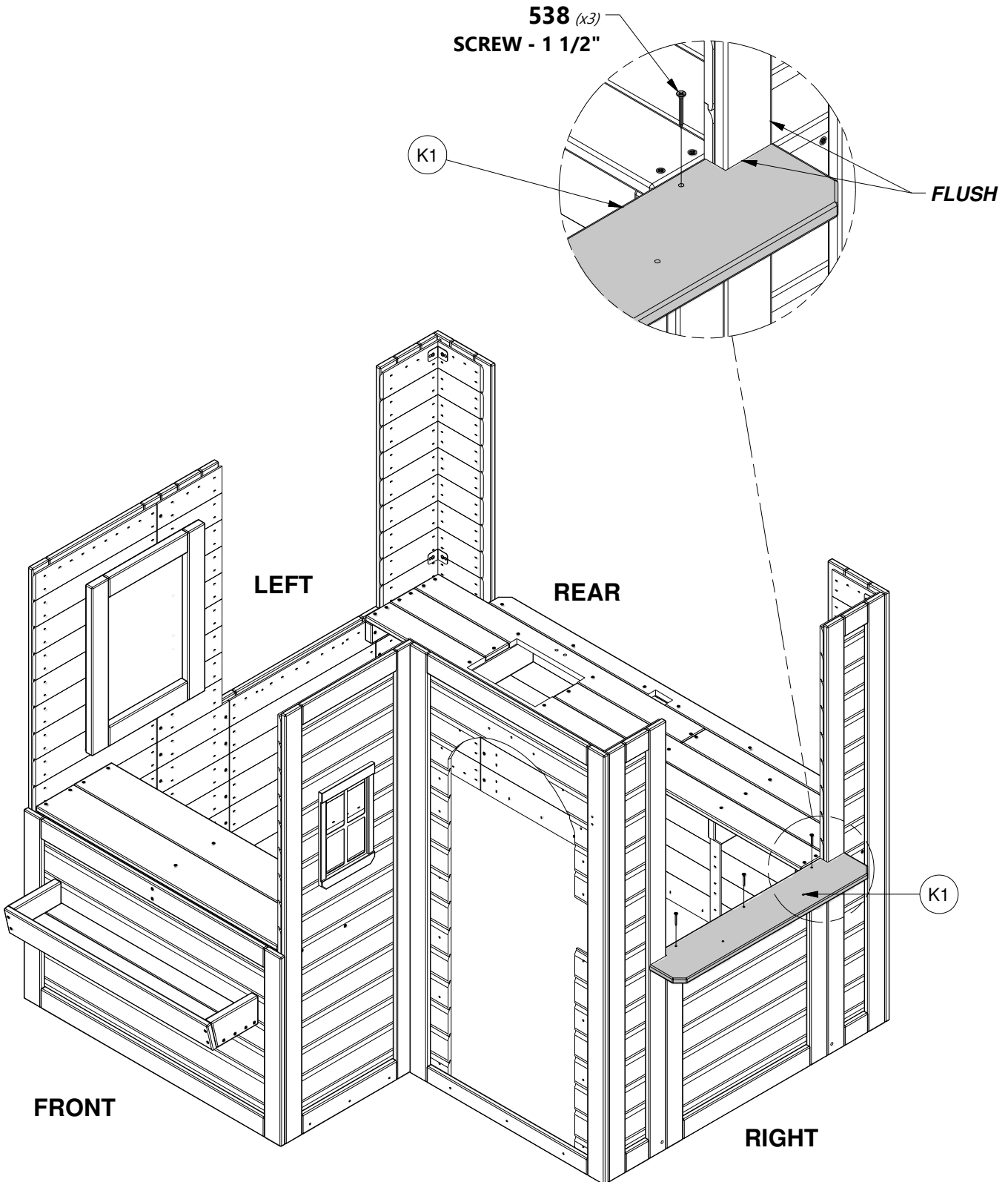

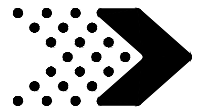

Phase 2

STEP 11

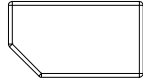

J1 | SUPPORT - W4L08949
(x2) | 15/16"x2 3/8"x4 3/16" (24x60x107)



H100542 | SCREW PFH SD
(x2) | 8x2



H100538 | SCREW PFH SD
(x2) | 8x1 1/2

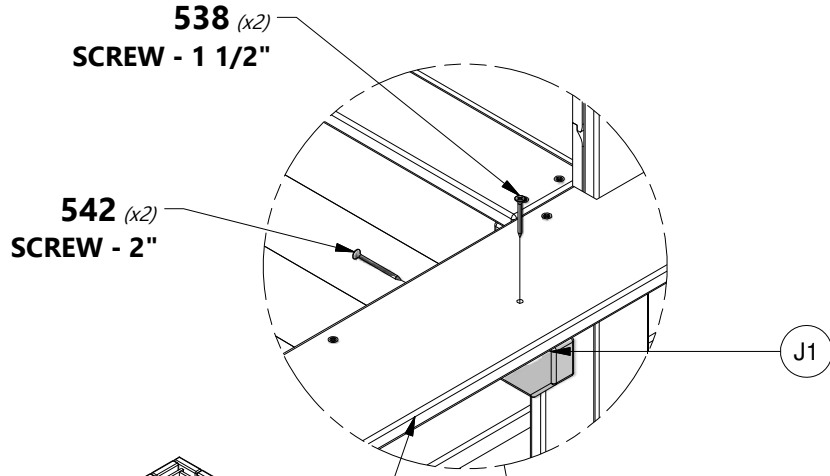

NOTE:
CENTER J1 WITH PILOT HOLES
IN K1 & WALL PANEL.

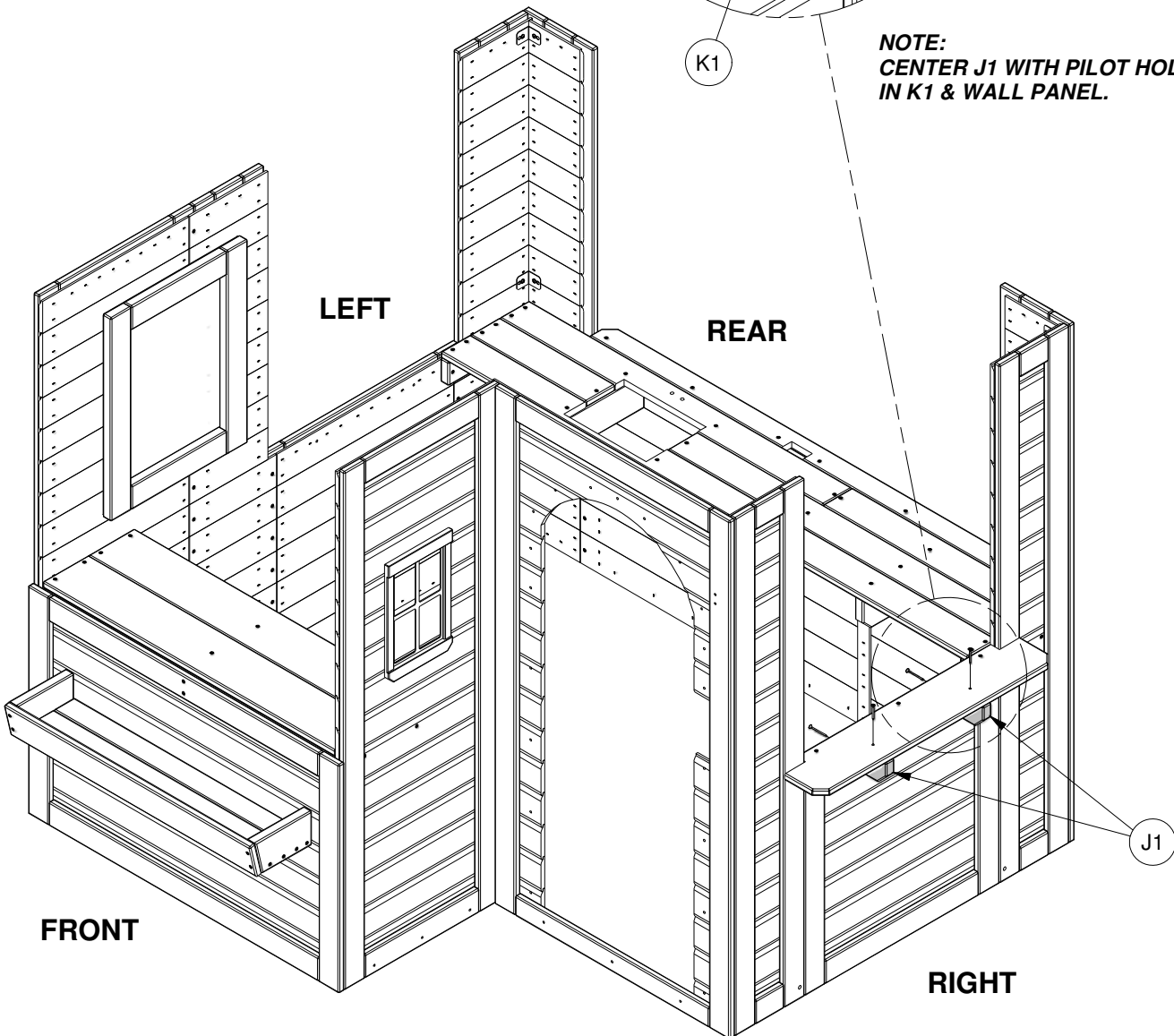

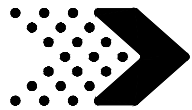

Phase 2

STEP 12

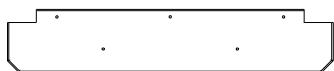

K1 | WINDOW TRIM - W4L08948
(x1) | 5/8"x5 1/4"x27 3/16" (16x134x690)



H100538 | SCREW PFH SD
(x3) | 8x1 1/2

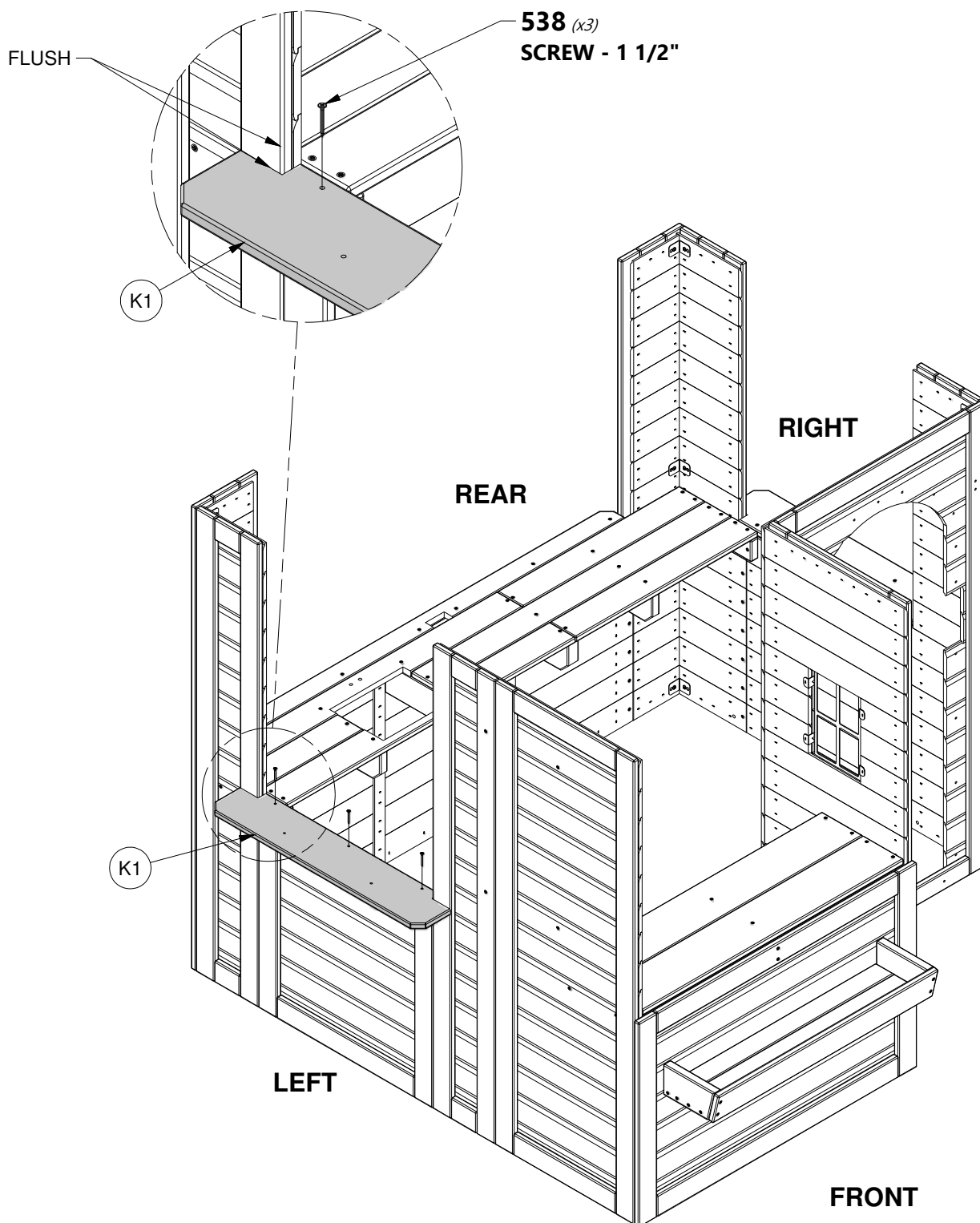

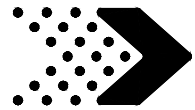

Phase 2

STEP 13

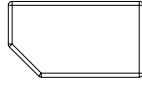

J1 | SUPPORT - W4L08949
(x2) | 15/16"x2 3/8"x4 3/16" (24x60x107)



H100542 | SCREW PFH SD
(x2) | 8x2



H100538 | SCREW PFH SD
(x2) | 8x1 1/2

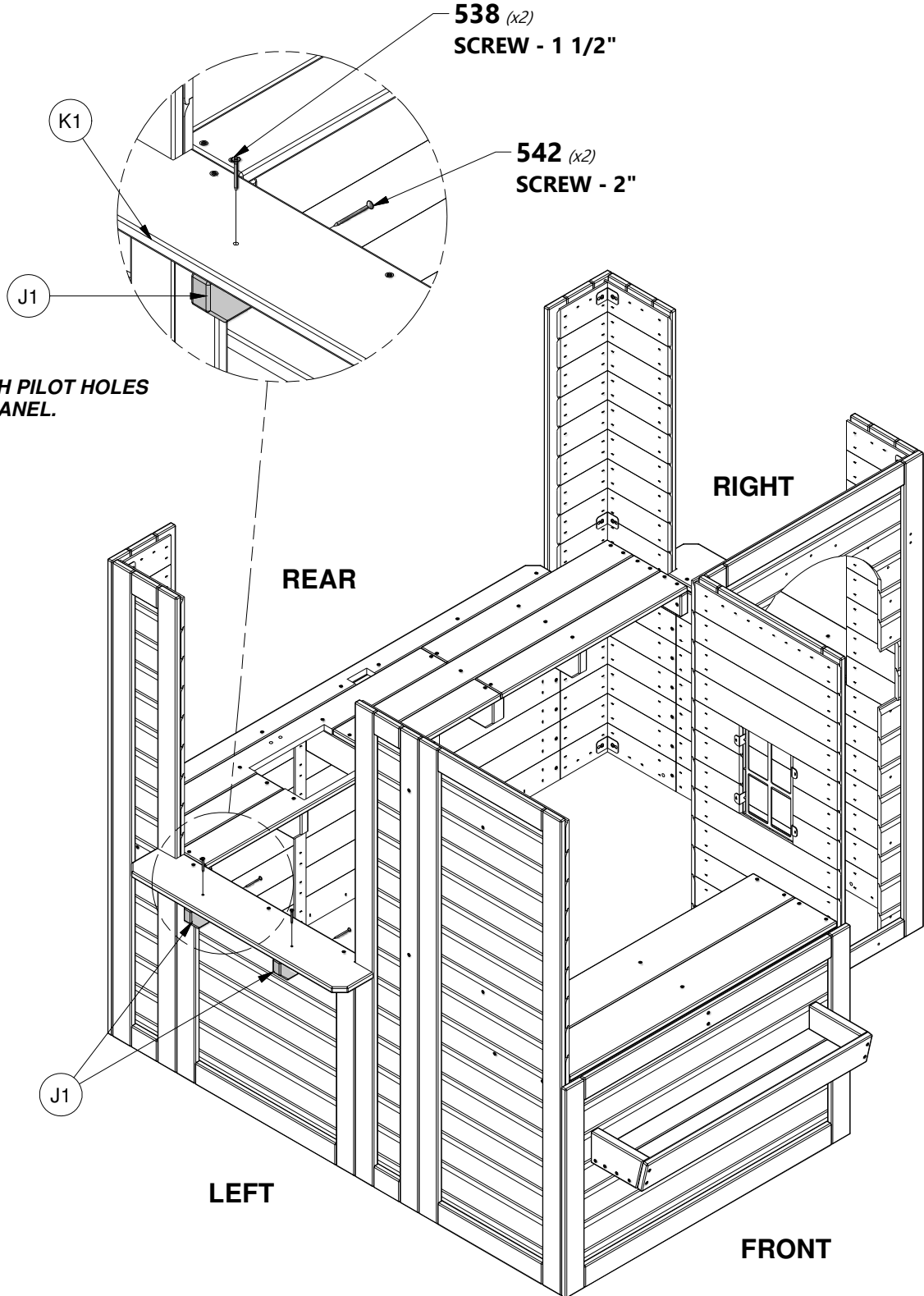

NOTE:
CENTER J1 WITH PILOT HOLES
IN K1 & WALL PANEL.

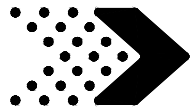

Phase 2

STEP 14

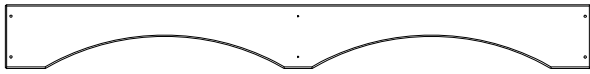

G1 | TOP RAIL - W4L08976
(x1) | 15/16"x5 1/4"x48 13/16" (24x134x1240)

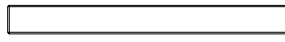

J3 | WINDOW POST - W4L08978
(x1) | 15/16"x2 3/8"x23 9/16" (24x60x599)

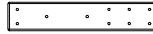

N6 | WALL CLEAT - W4L11792
(x1) | 5/8"x2 3/8"x12 3/8" (16x60x315)



H100538 | SCREW PFH SD
(x4) | 8x1 1/2

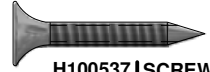

H100537 | SCREW PFH SD
(x4) | 8x1

NOTE:
ALIGN PILOT HOLES IN N6 WITH PILOT HOLES IN G1 AND ATTACH AS SHOWN.

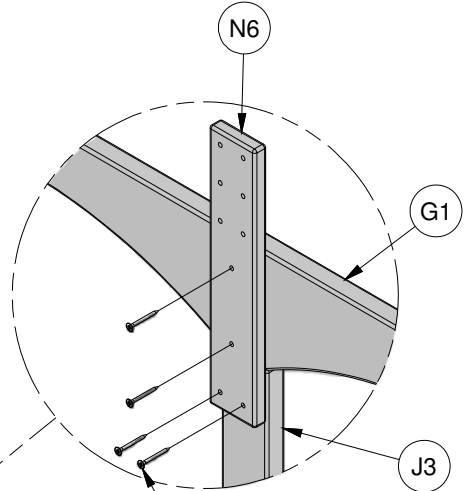
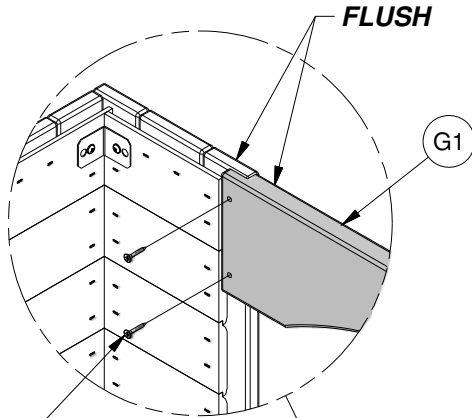

537 (x4)
SCREW - 1"

538 (x4)
SCREW - 1 1/2"

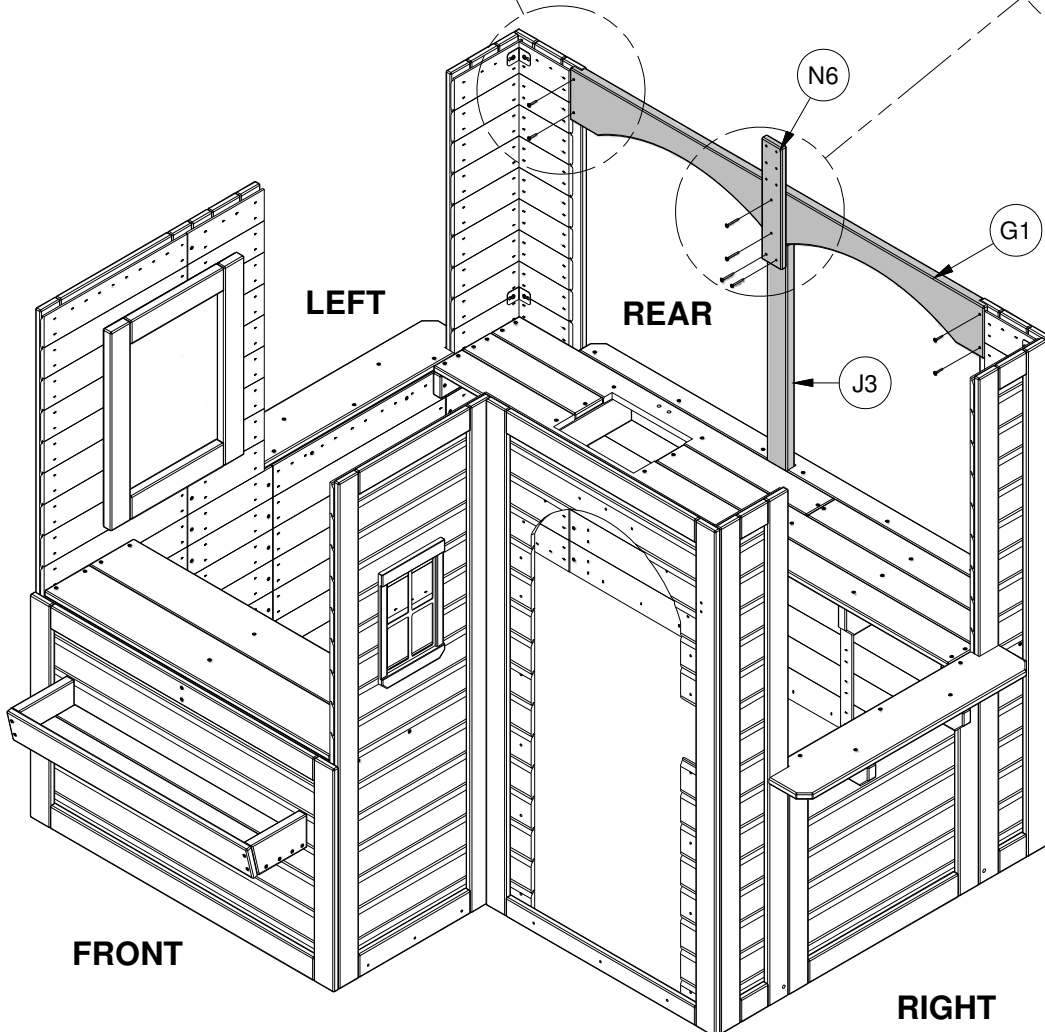

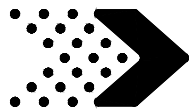

Phase 2

STEP 15



H4 | TOP RAIL - W4L08970
(x1) | 15/16"x3 3/8"x39 1/2" (24x86x1004)

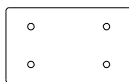

A4M00997 | METAL CLEAT
(x2)



H100797 | SCREW PWH BLK
(x8) | 8x1

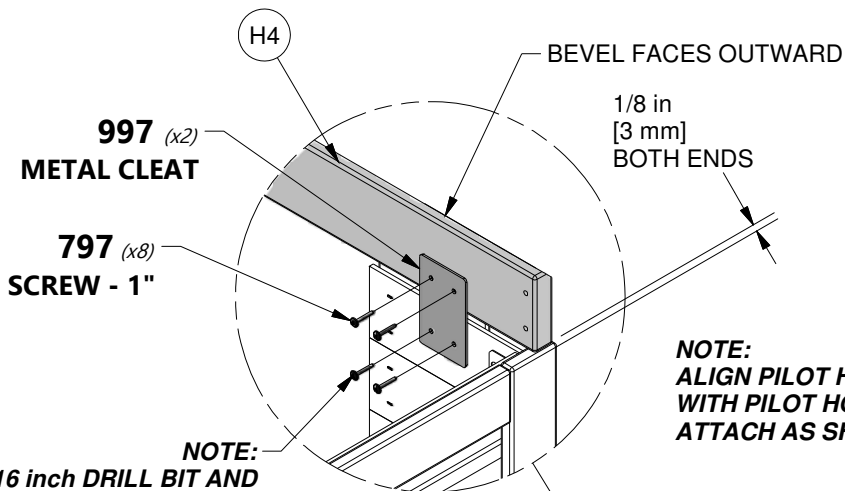

NOTE:
USING A 1/16 inch DRILL BIT AND METAL CLEAT AS A TEMPLATE. DRILL PILOT HOLES FOR BOTTOM SCREWS. DO NOT DRILL DEEPER THAN 3/4 inch.

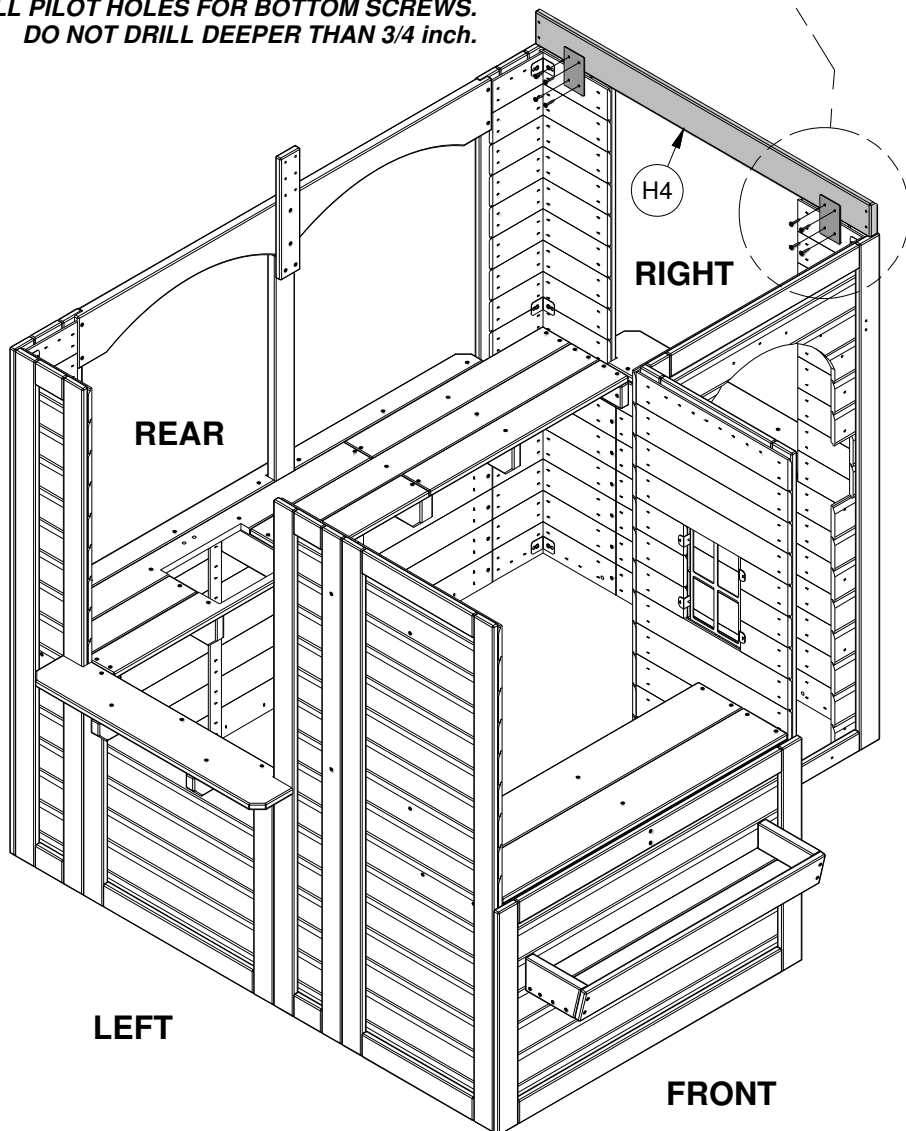

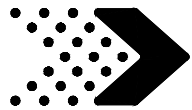

Phase 2

STEP 16

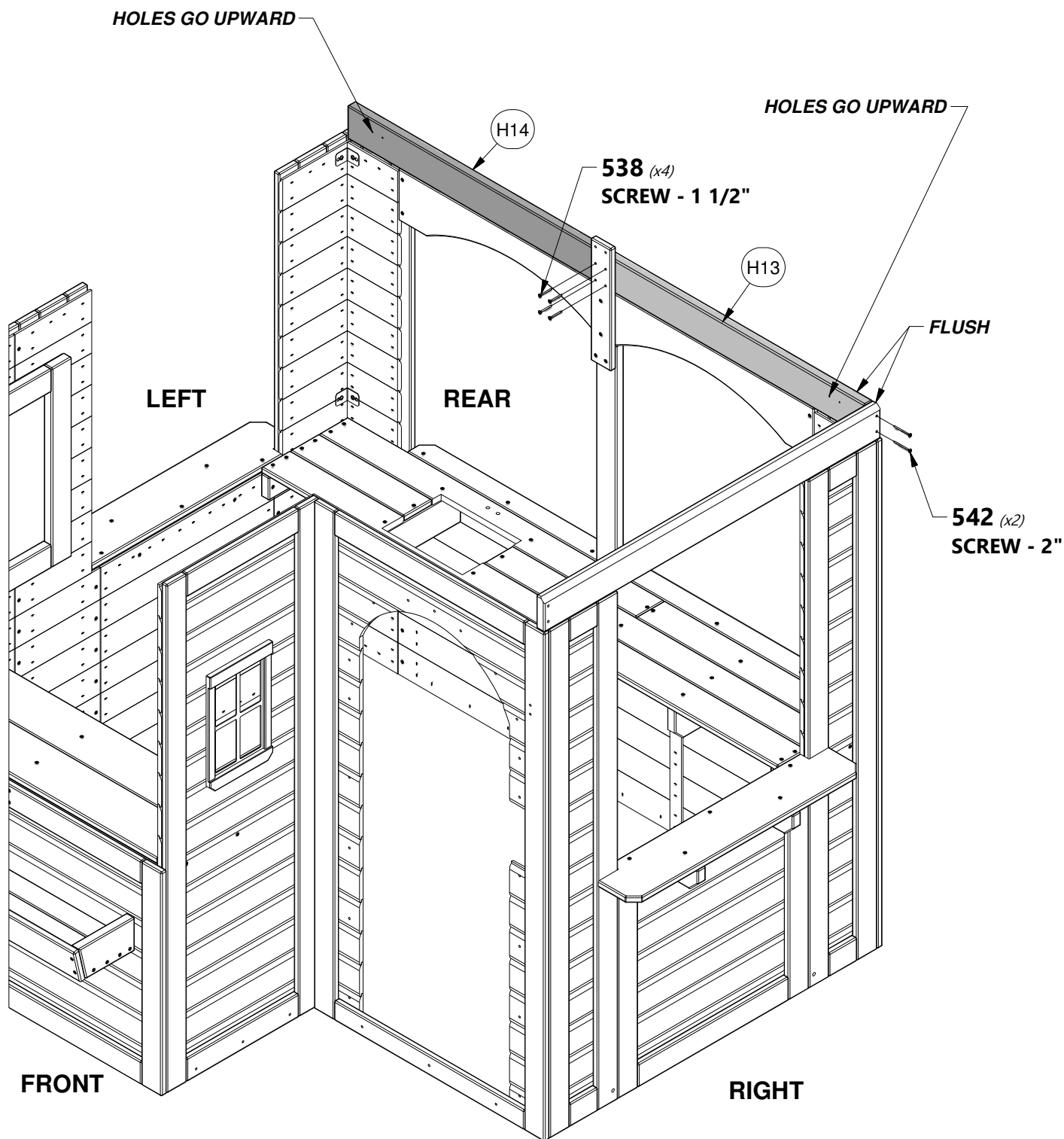
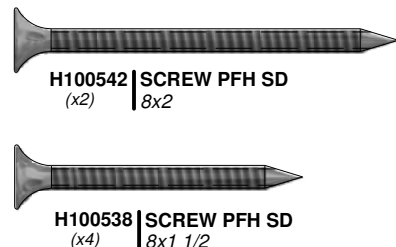
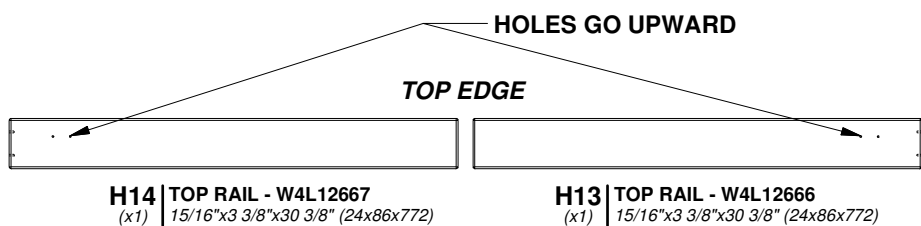

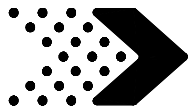

Phase 2

STEP 17



H3 TOP RAIL - W4L11786
(x1) 15/16"x3 3/8"x39 5/8" (24x86x1007)



J12 TOP RAIL - W4L12668
(x1) 15/16"x2 1/16"x17 13/16" (24x53x452)



A4M00997 METAL CLEAT
(x4)



H100542 SCREW PFH SD
(x2) 8x2



H100797 SCREW PWH BLK
(x16) 8x1

NOTE:
USING A 1/16 inch DRILL BIT AND METAL CLEAT AS A TEMPLATE. DRILL PILOT HOLES FOR BOTTOM SCREWS. DO NOT DRILL DEEPER THAN 3/4 inch.

542 (x2)
SCREW - 2"

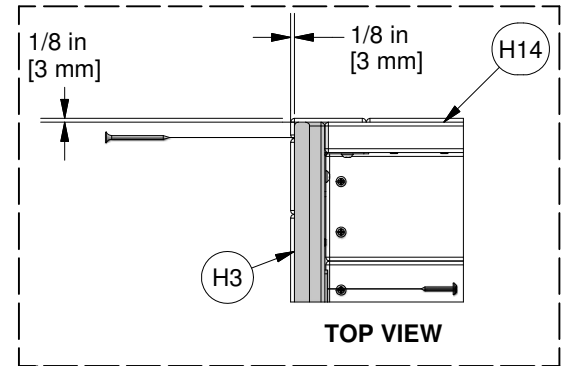

BEVEL FACES OUTWARD

FLUSH ALL SIDES

NOTE:
ALIGN PILOT HOLES IN METAL CLEATS WITH PILOT HOLES IN H3 & J12 THEN ATTACH AS SHOWN.

997 (x4)
METAL CLEAT

J12

797 (x16)
SCREW - 1"

LEFT

REAR

FRONT

RIGHT

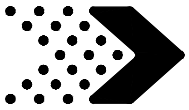

Phase 2

STEP 18



H7 | TOP RAIL - W4L11794
(x1) | 15/16"x3 3/8"x31 1/2" (24x86x800)



A4M00997 | METAL CLEAT
(x2)



H100542 | SCREW PFH SD
(x3) | 8x2



H6 | TOP RAIL - W4L11787
(x1) | 15/16"x2 1/16"x17 15/16" (24x53x455)



H100797 | SCREW PWH BLK
(x8) | 8x1

NOTE:
ALIGN PILOT HOLES IN METAL CLEATS WITH
PILOT HOLES IN H6 AND ATTACH AS SHOWN.

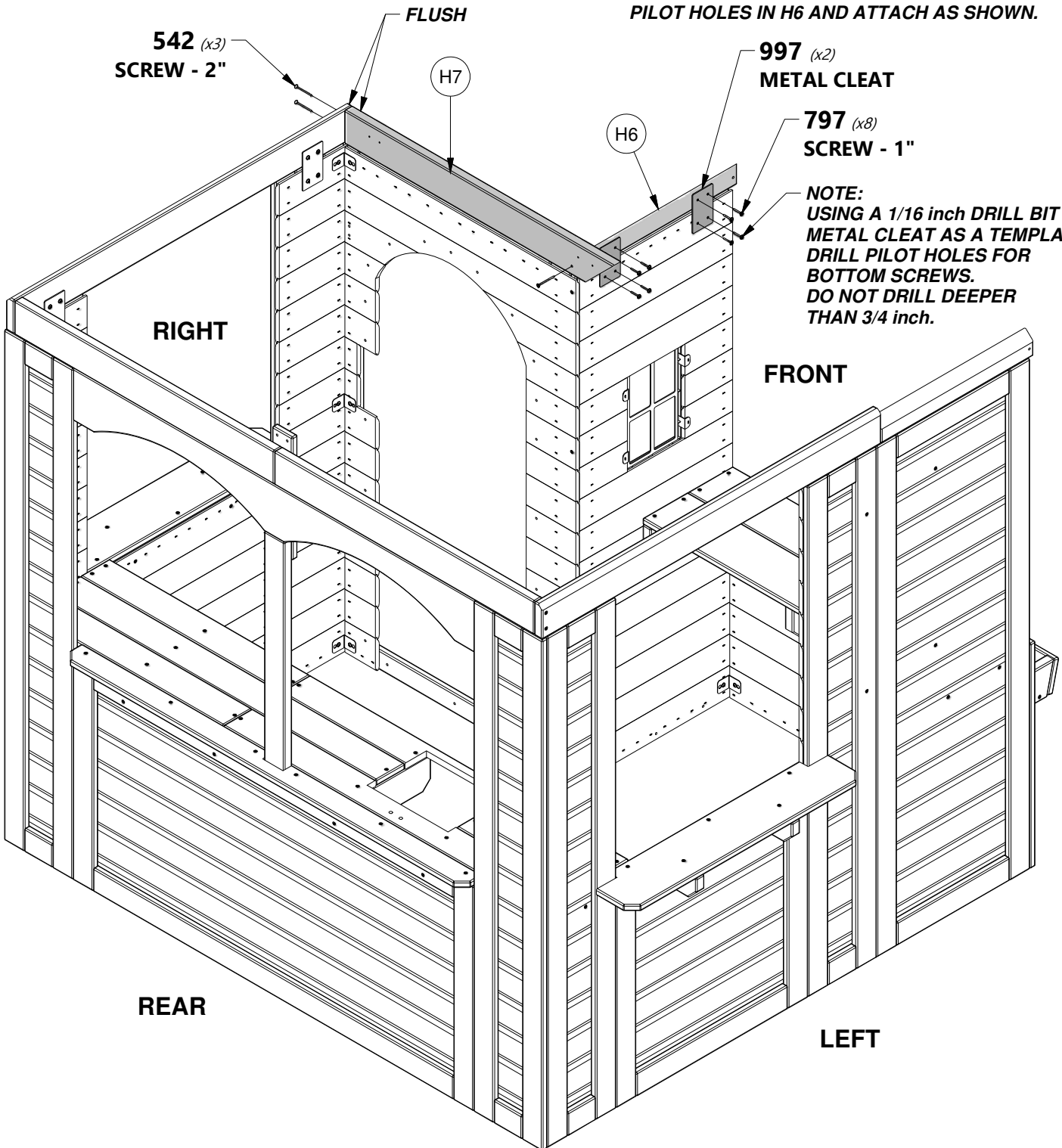

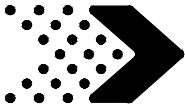

Phase 2

STEP 19



H8 | TOP RAIL - W4L11788
(x1) | 15/16"x3 3/8"x33 11/16" (24x86x856)



H100542 | SCREW PFH SD
(x2) | 8x2

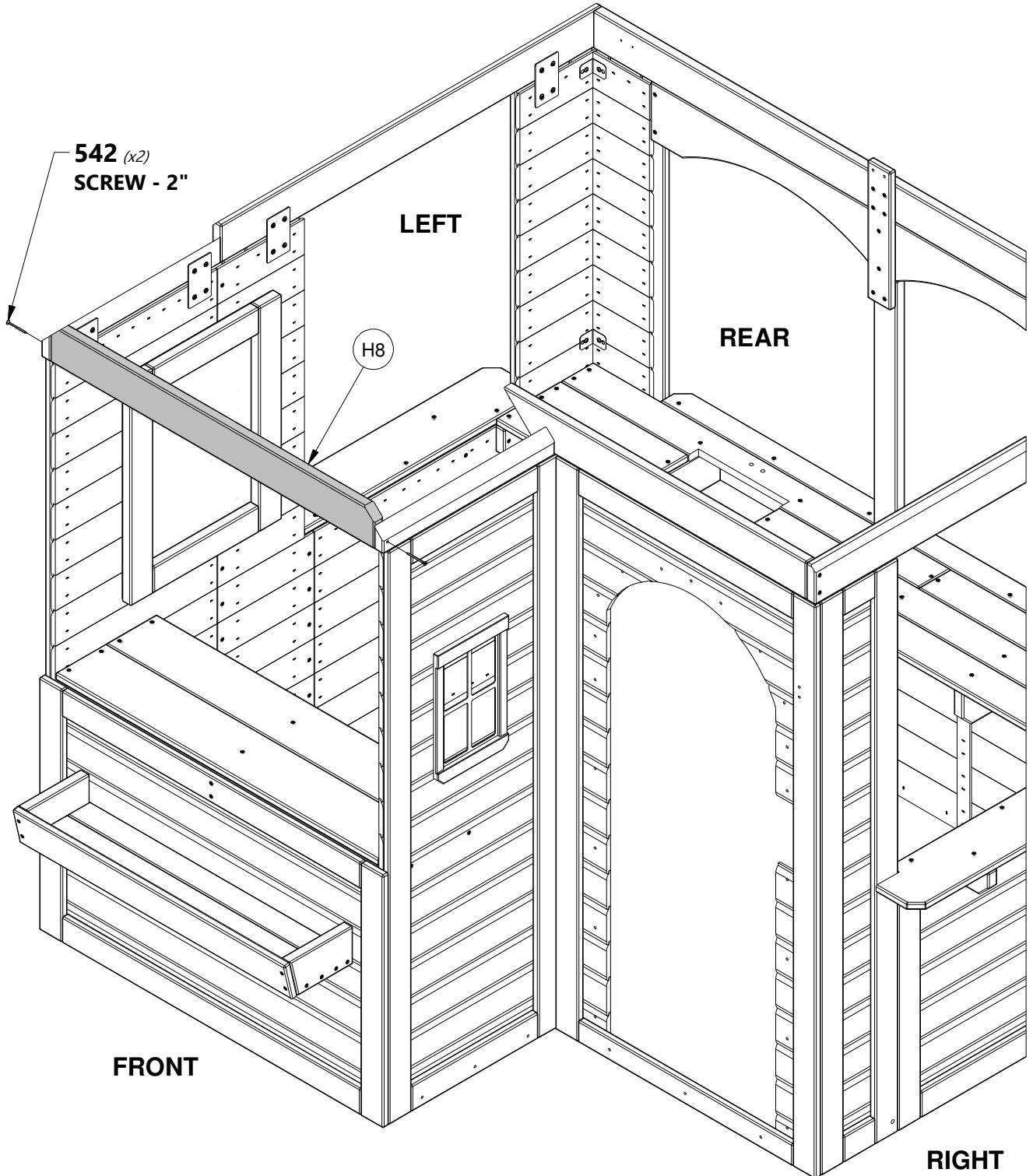

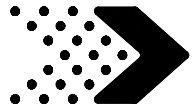

Phase 2

STEP 20

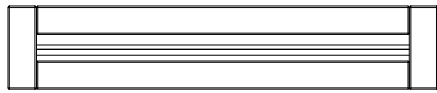

WP9 | WALL PANEL - W2A02531
(x1) | 1 1/16"x6 15/16"x35 13/16" (27x176x910)

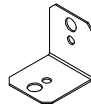

A4M00555 | 90° L-BRACKET - BLK
(x2)



H100392 | SCREW PWH BLK
(x4) | 8x3/4

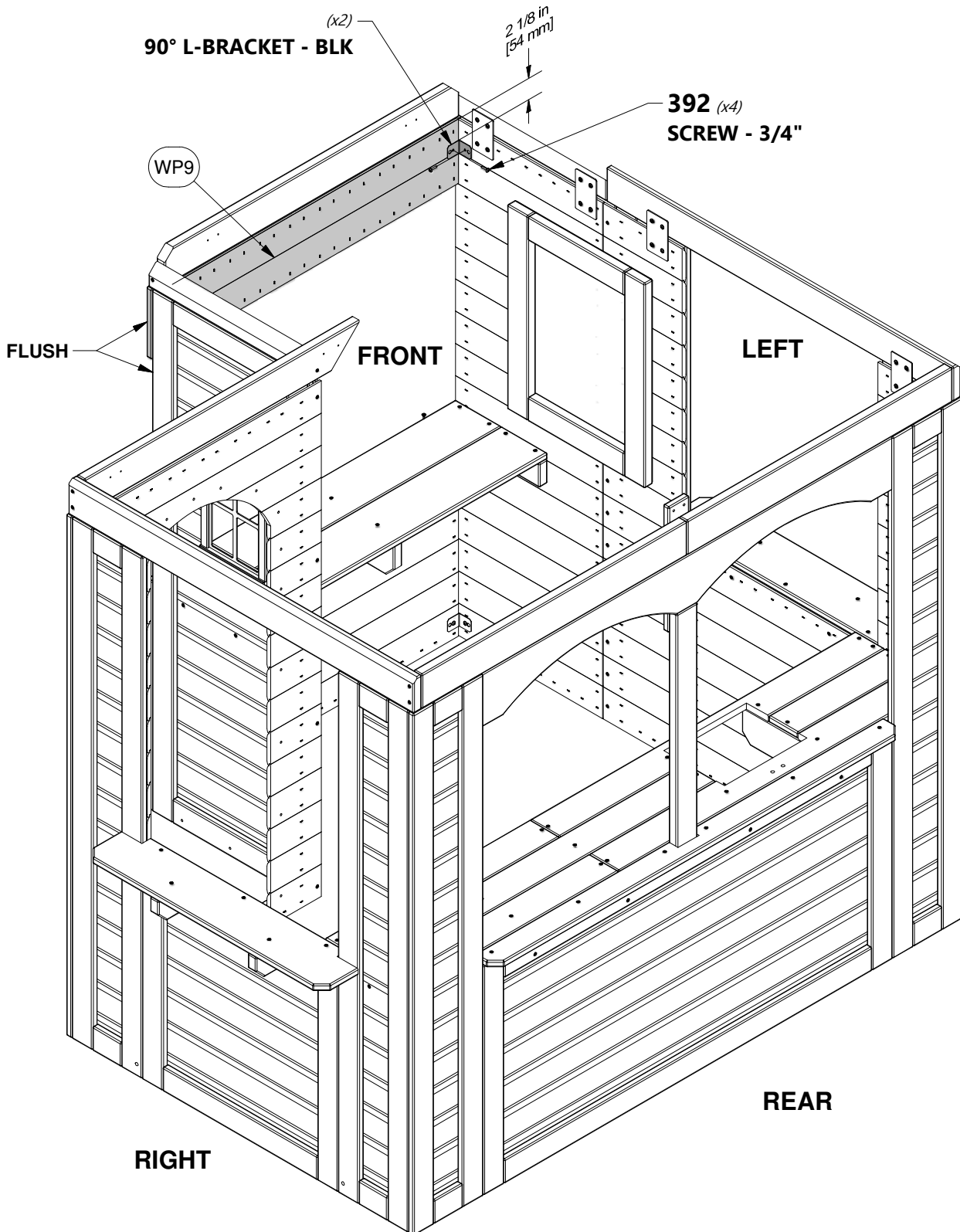

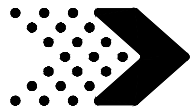

Phase 2

STEP 21



J2 | BAY WINDOW - W4L08975
(x1) | 15/16"x2 3/8"x35 13/16" (24x60x910)

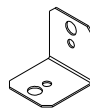

A4M00555 | 90° L-BRACKET - BLK
(x2)



H100392 | SCREW PWH BLK
(x4) | 8x3/4

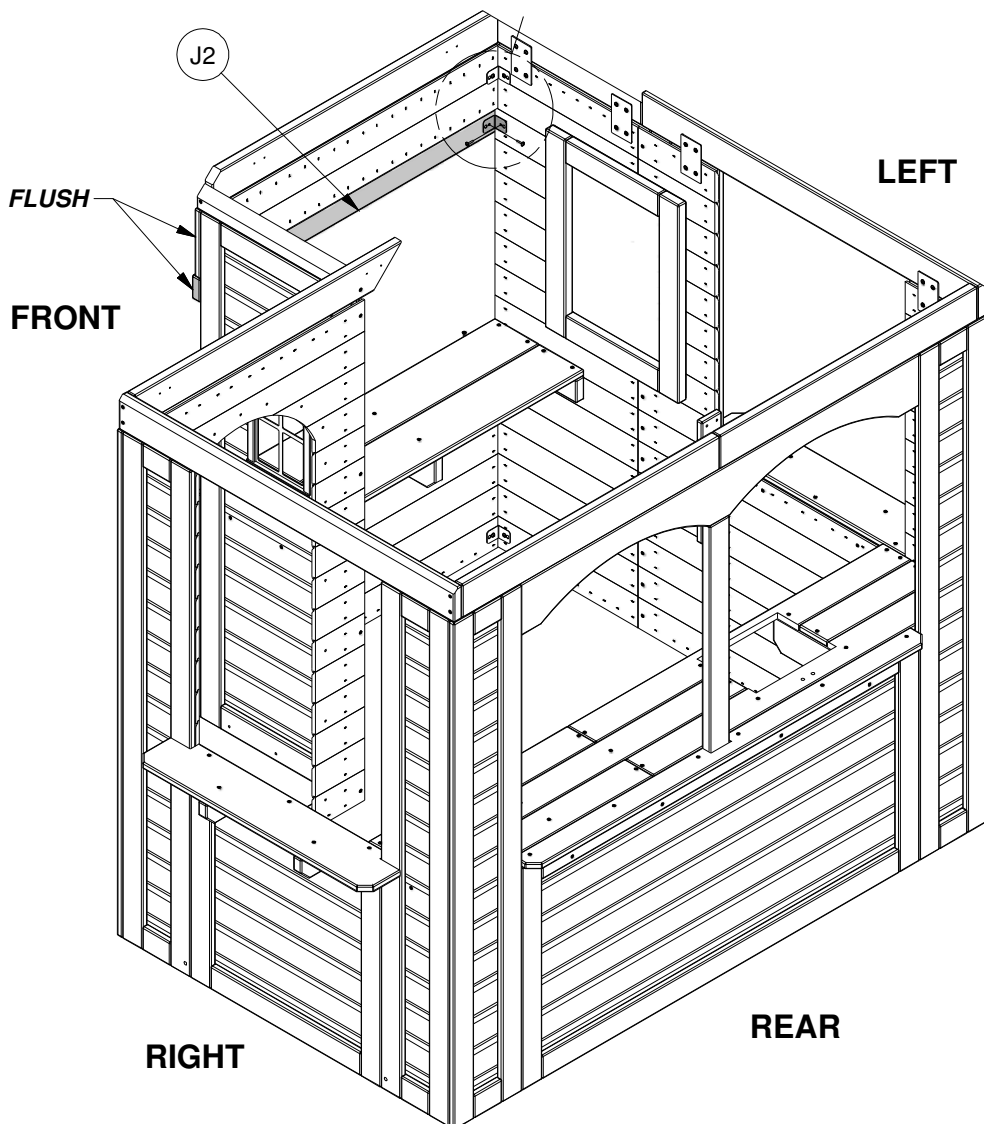
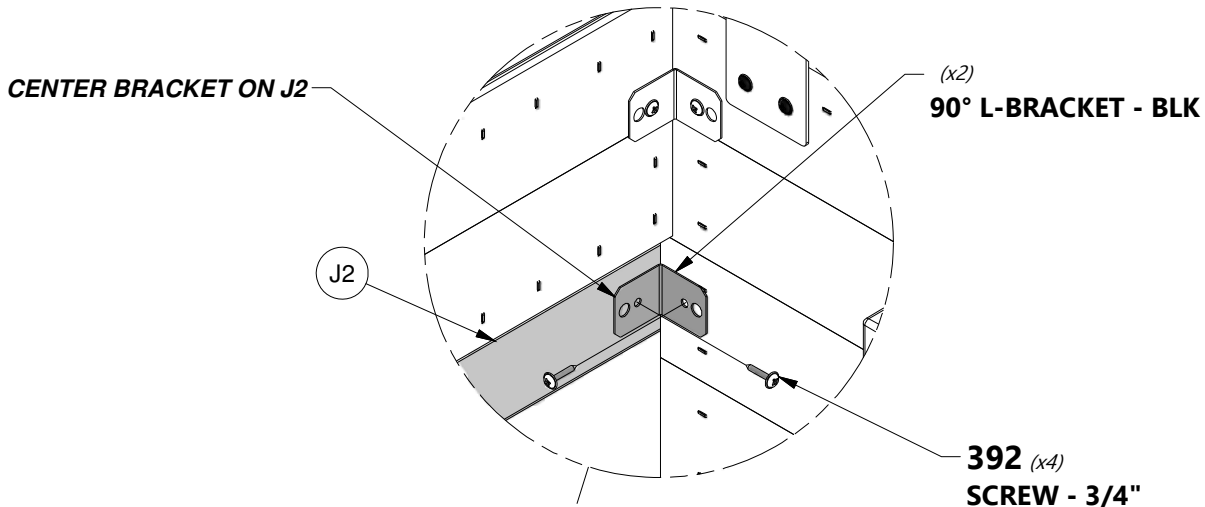

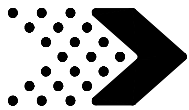

Phase 2

STEP 22

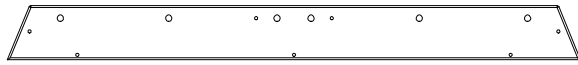

M1 | WINDOW TRIM - W4L08950
(x2) | 5/8"x3 3/8"x35 13/16" (16x86x910)



H2 | WINDOW TRIM - W4L08951
(x2) | 15/16"x3 3/8"x18 1/4" (24x86x464)



A100373 | BAY WINDOW PANEL
(x2)



H100541 | SCREW PFH SD
(x4) | 8x1 3/4



H100537 | SCREW PFH SD
(x4) | 8x1

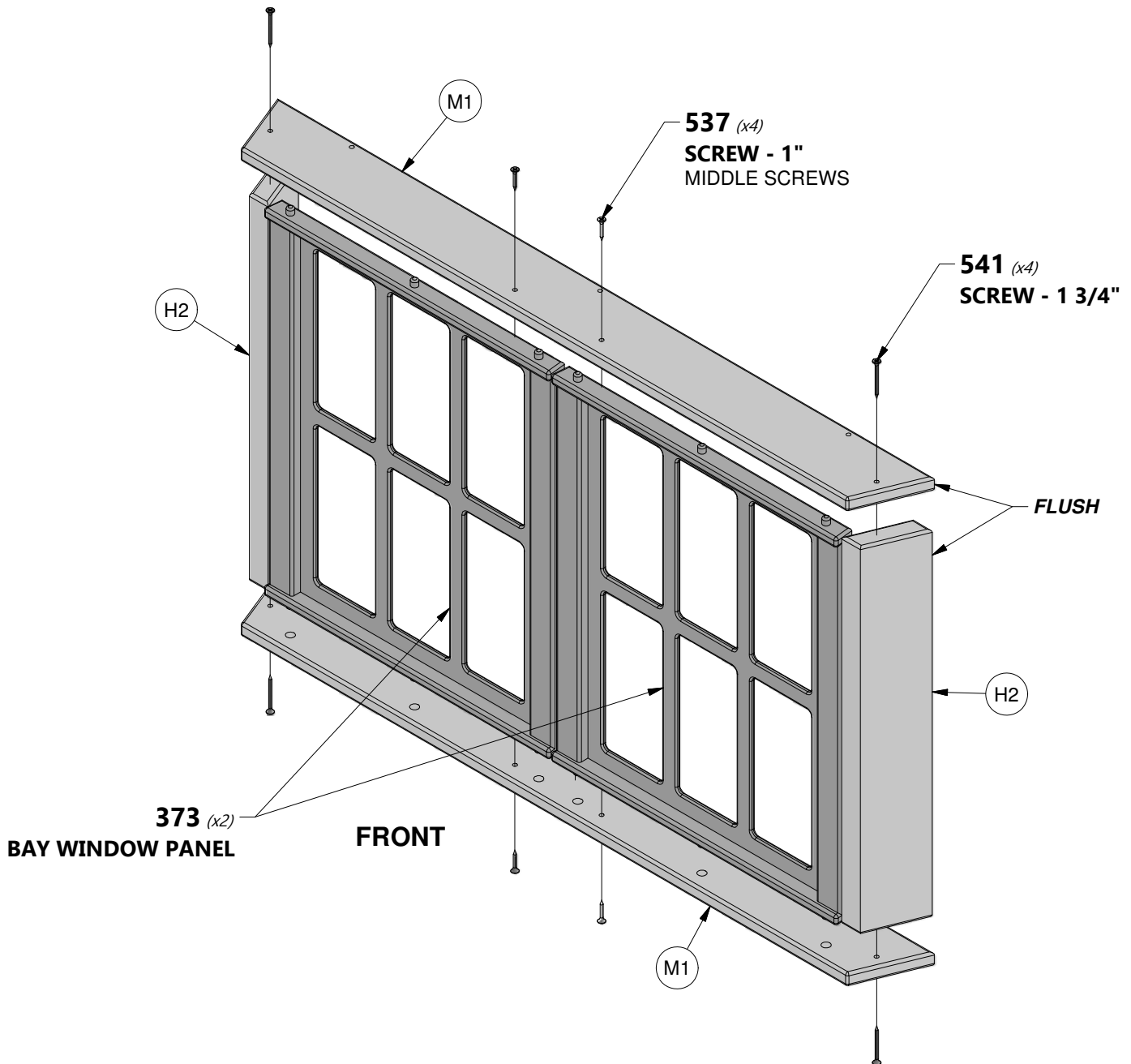

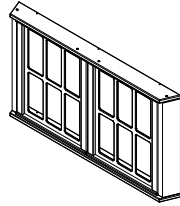
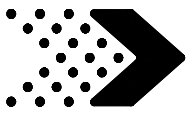

(x1) BAY WINDOW PANEL ASSEMBLY FROM PREVIOUS STEP



H100538 | SCREW PFH SD (x6) | 8x1 1/2

BAY WINDOW PANEL ASSEMBLY FROM PREVIOUS STEP

NOTE: CENTER BAY WINDOW ASSEMBLY IN OPENING.

538 (x6) SCREW - 1 1/2"

FRONT

RIGHT

LEFT

REAR

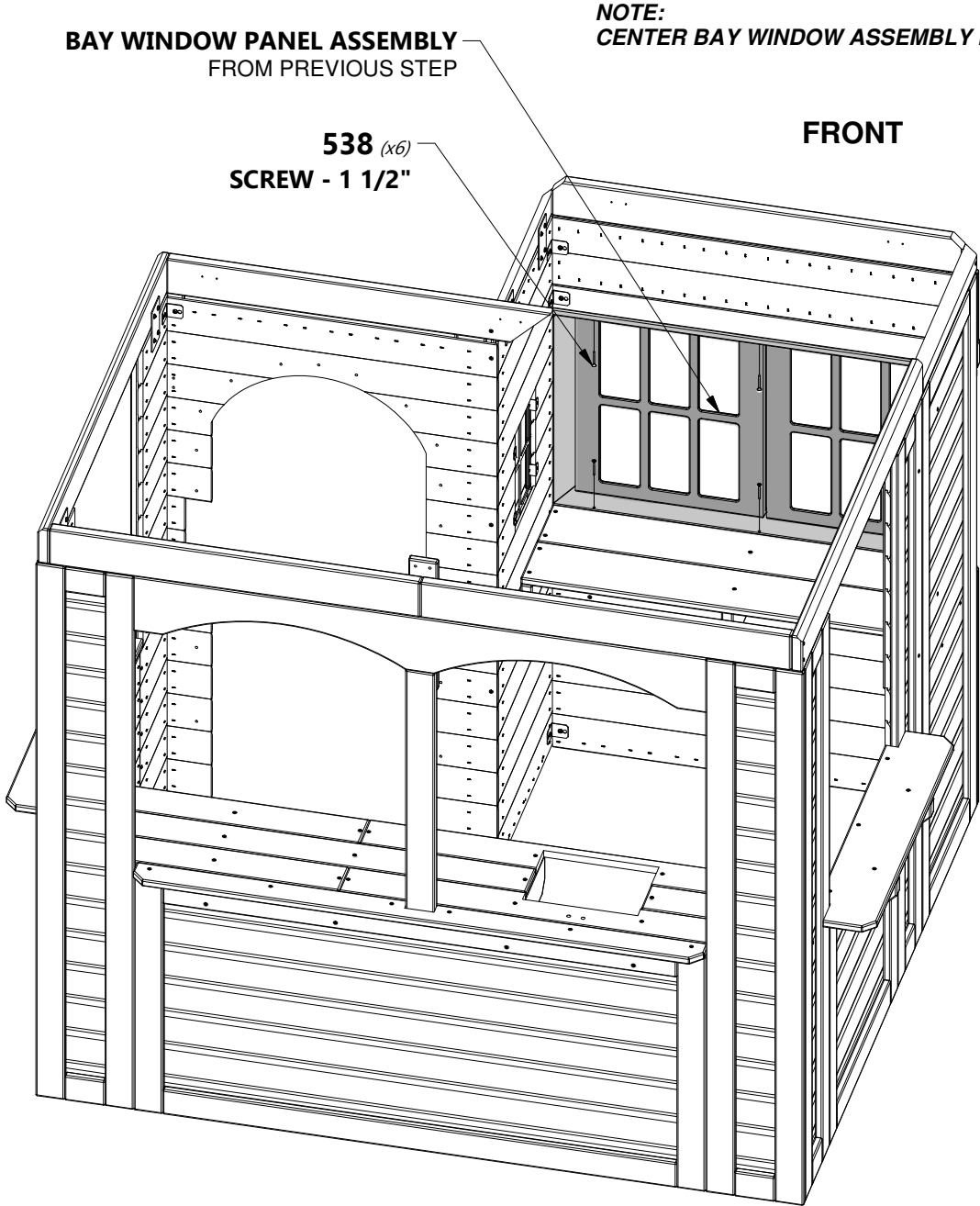



Phase 2

STEP 24

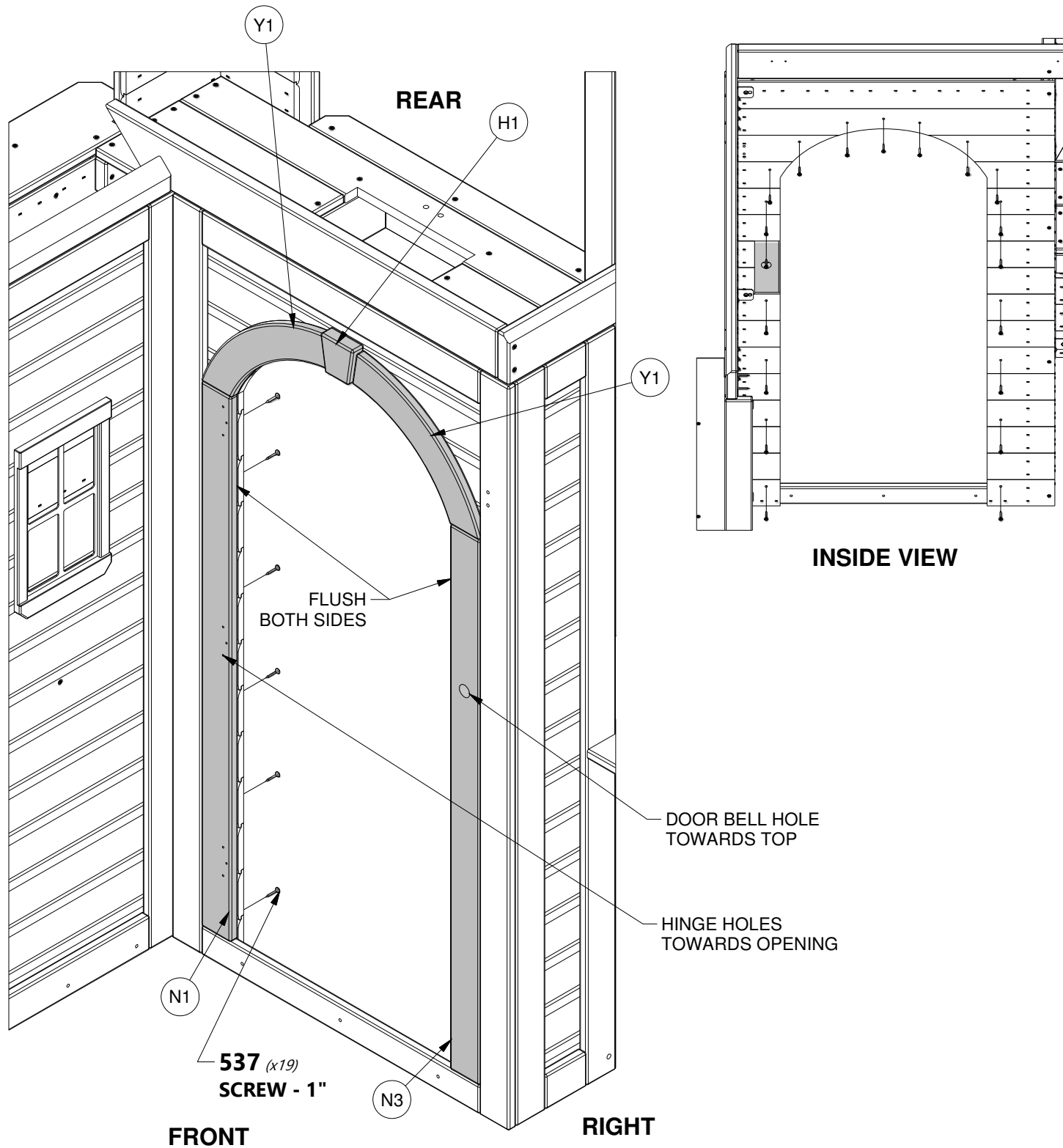
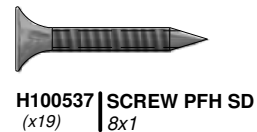
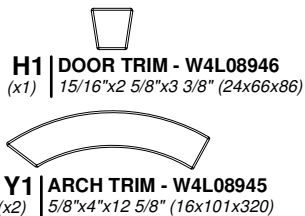
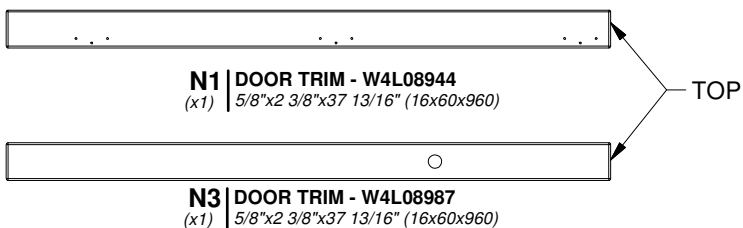

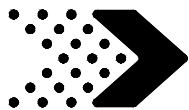

Phase 3

STEP 1

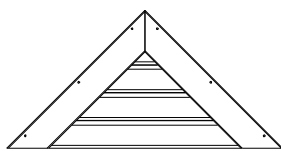

GP2 | GABLE PANEL - W2A02635
(x1) 1 1/16"x17 7/8"x35 13/16" (27x402x803)



A4M00997 | METAL CLEAT
(x2)



H100797 | SCREW PWH BLK
(x8) | 8x1

NOTE:
USING A 1/16 inch DRILL BIT AND METAL CLEAT AS A TEMPLATE. DRILL PILOT HOLES FOR TOP SCREWS. DO NOT DRILL DEEPER THAN 3/4 inch.

NOTE:
ALIGN PILOT HOLES IN METAL CLEATS WITH PILOT HOLES IN H8 AND ATTACH AS SHOWN.

RIGHT

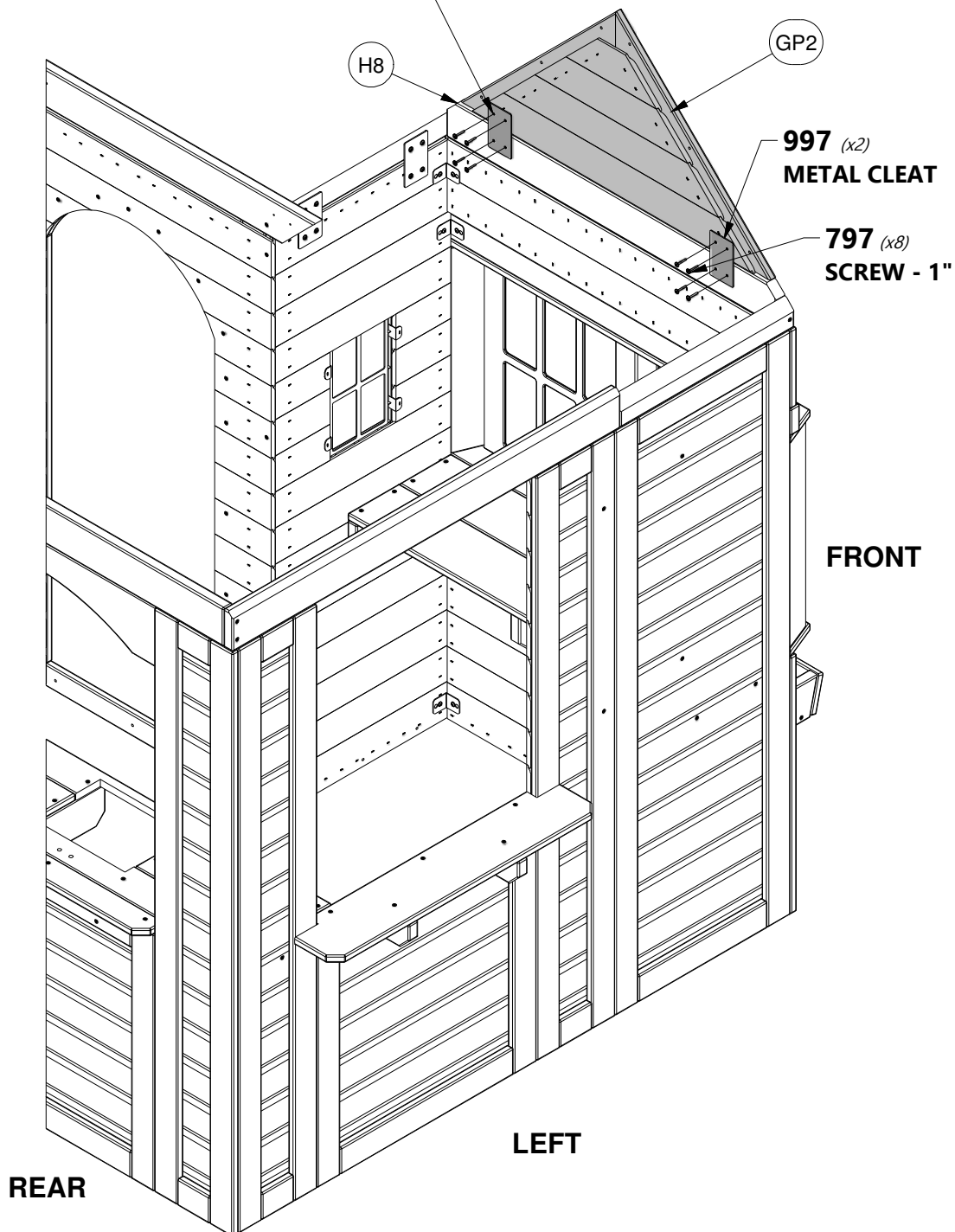

FRONT

LEFT

REAR

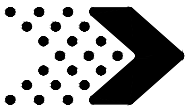

Phase 3

STEP 2



M4 | RAFTER - W4L11793
(x1) | 5/8"x3 3/8"x46 5/16" (16x86x1177)

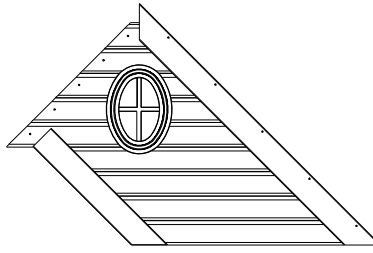

GP4 | GABLE PANEL - W2A02639
(x1) | 1 1/16"x31 7/16"x48 3/4" (27x798x1238)



H100537 | SCREW PFH SD
(x5) | 8x1

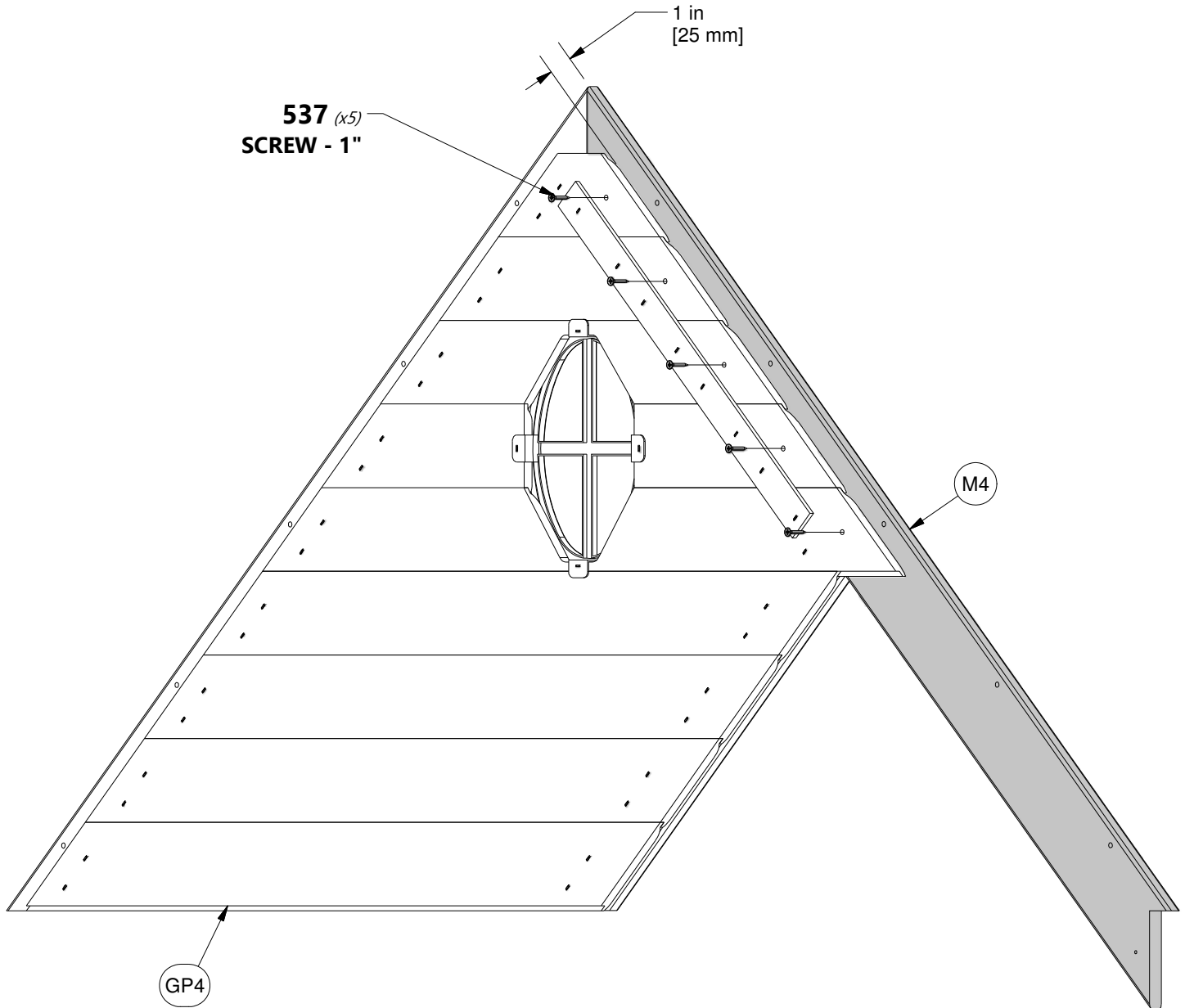

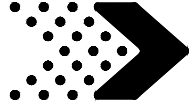

Phase 3

STEP 3

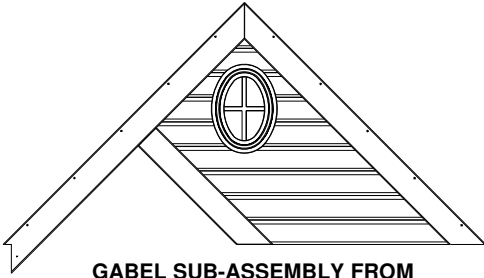

GABLE SUB-ASSEMBLY FROM PHASE 3, STEP 2

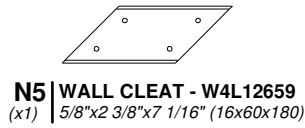

N5 | WALL CLEAT - W4L12659
(x1) | 5/8"x2 3/8"x7 1/16" (16x60x180)

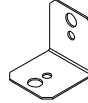

A4M00555 | 90° L-BRACKET - BLK
(x1)



A4M00997 | METAL CLEAT
(x1)

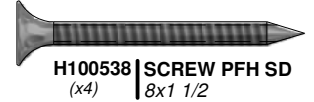

H100538 | SCREW PFH SD
(x4) | 8x1 1/2

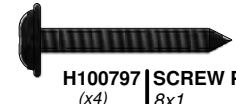

H100797 | SCREW PWH BLK
(x4) | 8x1



H100202 | SCREW PWH BLK
(x2) | 8x5/8

NOTE:
USING A 1/16 inch DRILL BIT AND CLEATS AS A TEMPLATE,
DRILL PILOT HOLES FOR TOP SCREWS.
DO NOT DRILL DEEPER THAN 3/4 inch.

NOTE:
ALIGN PILOT HOLES IN N5 WALL
CLEAT AND METAL CLEAT WITH
PILOT HOLES IN H7 AND ATTACH AS
SHOWN.

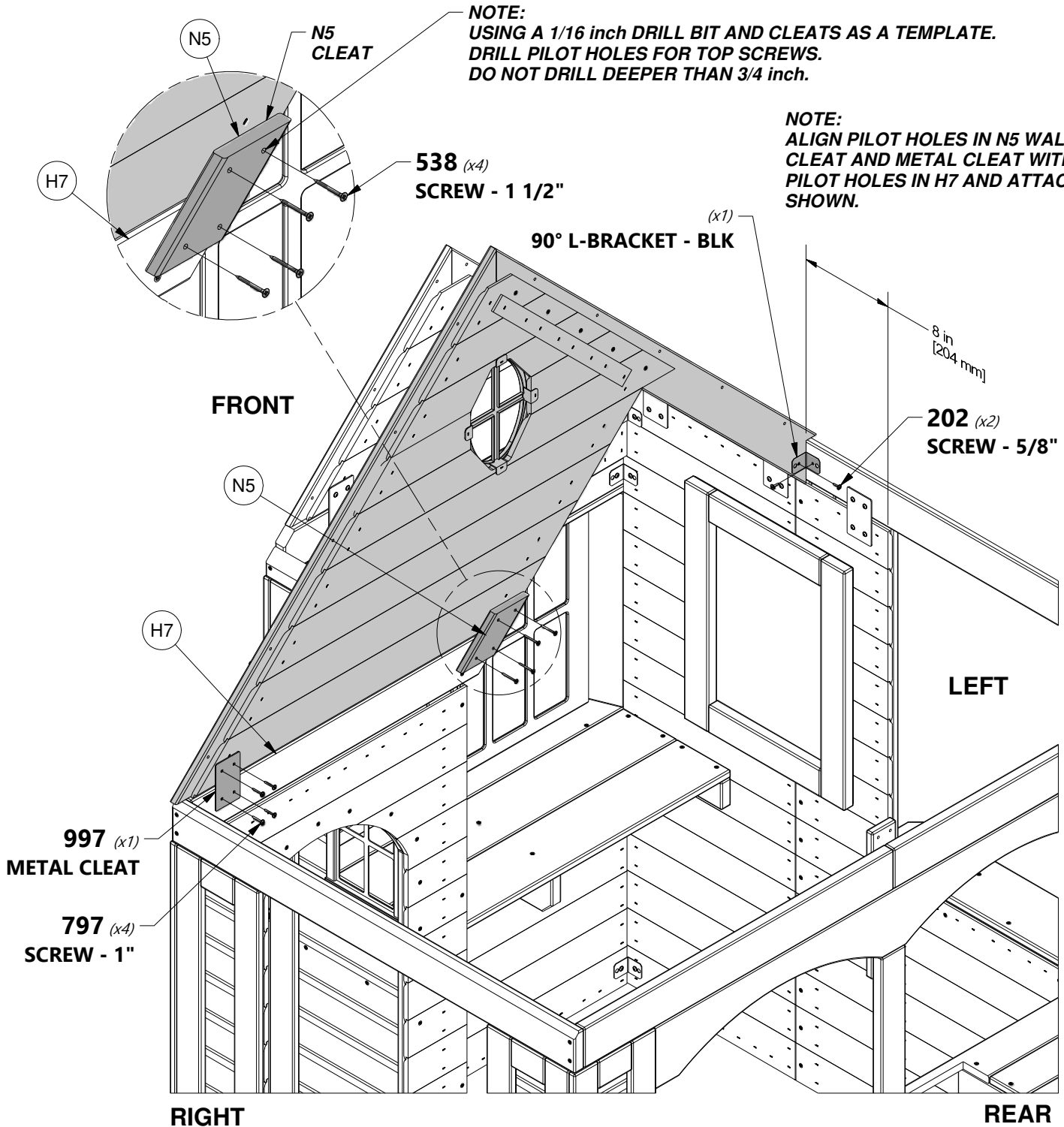

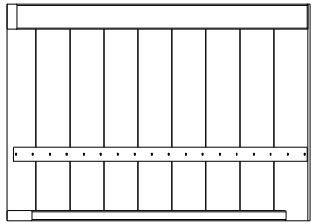

RP1 | ROOF PANEL - W2A02637
(x1) | 2 13/16"x20 1/4"x28 7/16" (71x515x722)



H100541 | SCREW PFH SD
(x4) | 8x1 3/4



H100538 | SCREW PFH SD
(x3) | 8x1 1/2

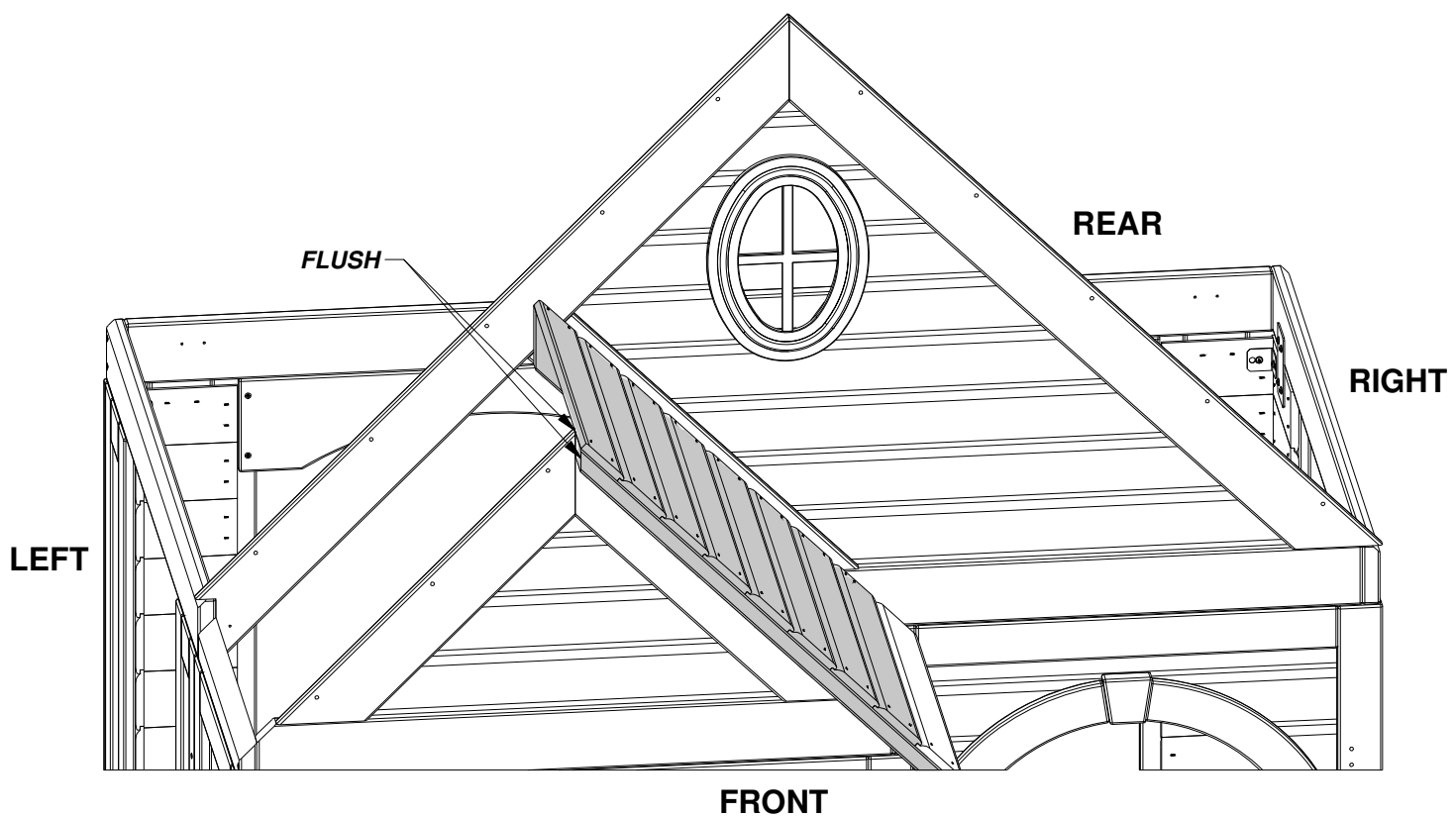
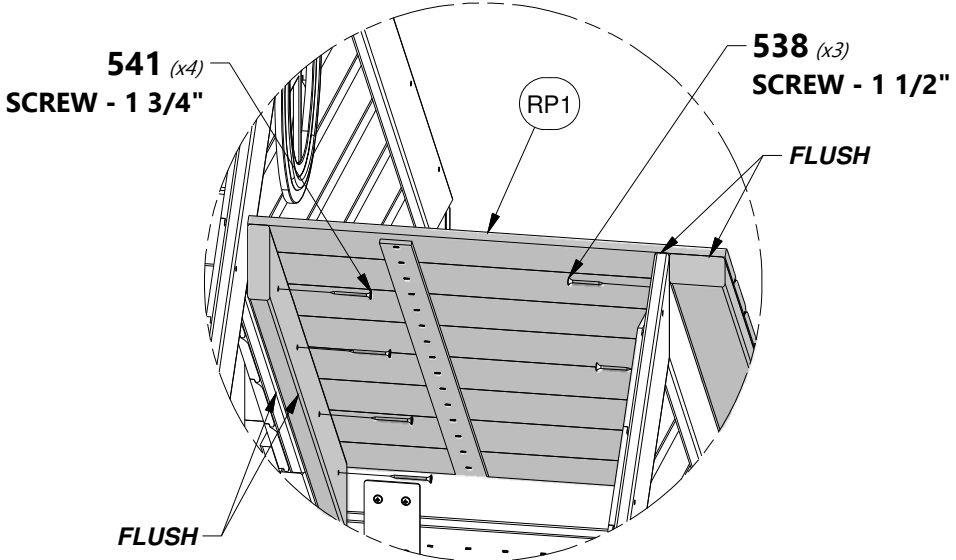

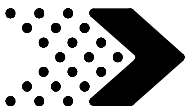

Phase 3

STEP 5

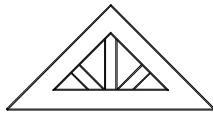

A100322 | PLASTIC SUNBURST
(x1)

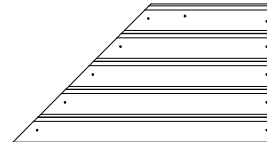

GP6 | GABLE PANEL - W2A02638
(x1) | 5/8"x16 1/8"x29 7/8" (16x410x759)

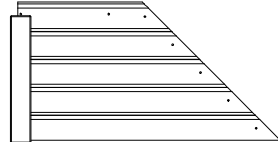

GP3 | GABLE PANEL - W2A02636
(x1) | 1 1/4"x16 1/8"x31 1/4" (32x410x794)



AB1 | GABLE CLEAT - W4L11791
(x2) | 1/2"x2 3/8"x11 3/4" (12x60x300)

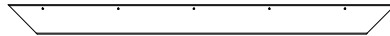

M8 | RAFTER - W4L11790
(x2) | 5/8"x3 3/8"x44 7/16" (16x86x1129)



H100537 | SCREW PFH SD
(x23) | 8x1



H100797 | SCREW PWH BLK
(x7) | 8x1

NOTE:
ALIGN PILOT HOLES IN PLASTIC SUNBURST
WITH PILOT HOLES IN AB1 GABLE CLEATS.
ATTACH USING THE 797 SCREWS.

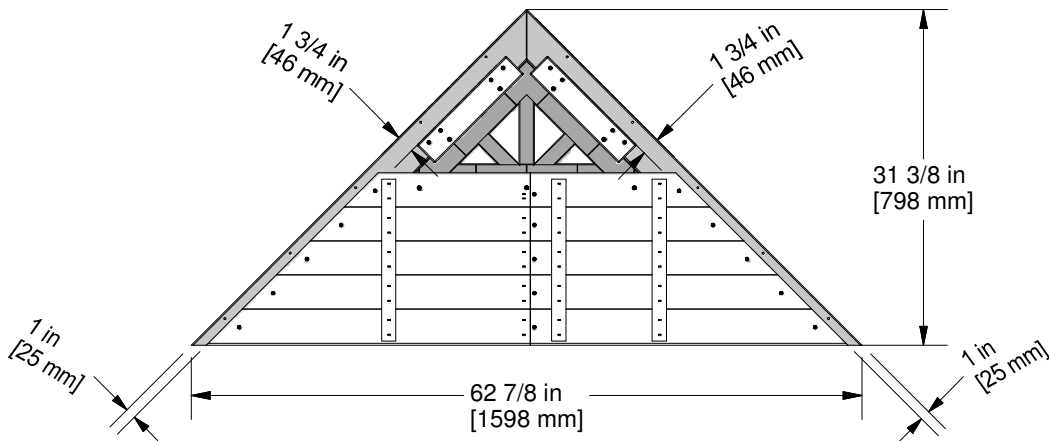
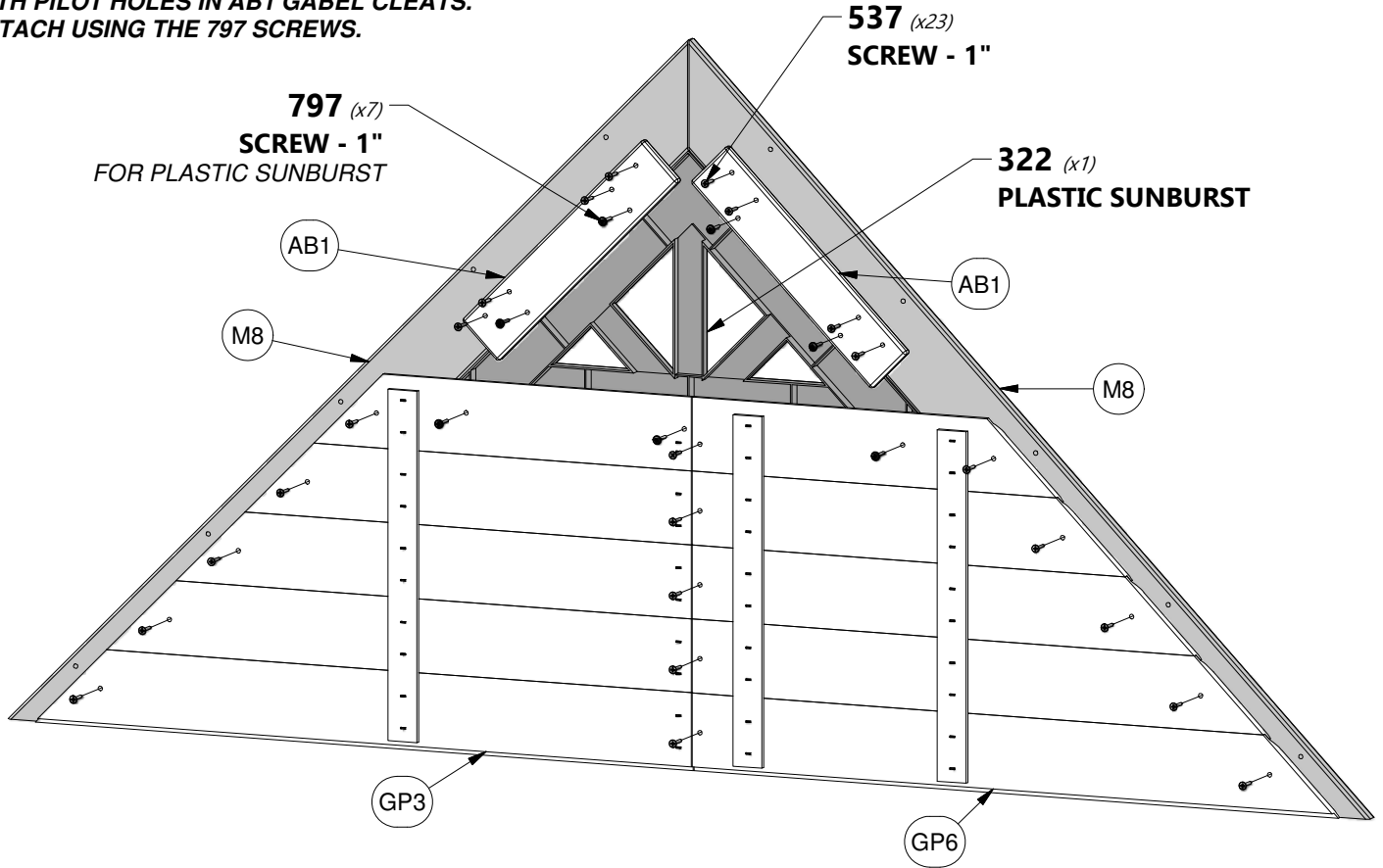

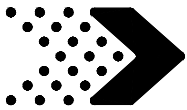

Phase 3

STEP 6

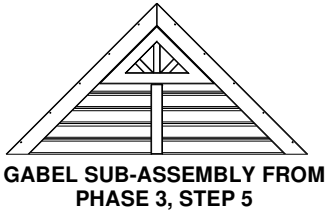

GABEL SUB-ASSEMBLY FROM PHASE 3, STEP 5

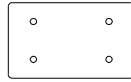

A4M00997 (x2) METAL CLEAT



H100538 SCREW PFH SD (x2) 8x1 1/2



H100797 SCREW PWH BLK (x8) 8x1

997 (x2) METAL CLEAT

797 (x8) SCREW - 1"

NOTE:
USING A 1/16 inch DRILL BIT AND METAL CLEAT AS A TEMPLATE. DRILL PILOT HOLES FOR TOP SCREWS. DO NOT DRILL DEEPER THAN 3/4 inch.

H13

NOTE:
ALIGN PILOT HOLES IN METAL CLEATS WITH PILOT HOLES IN H5 AND ATTACH AS SHOWN.

538 (x2) SCREW - 1 1/2"

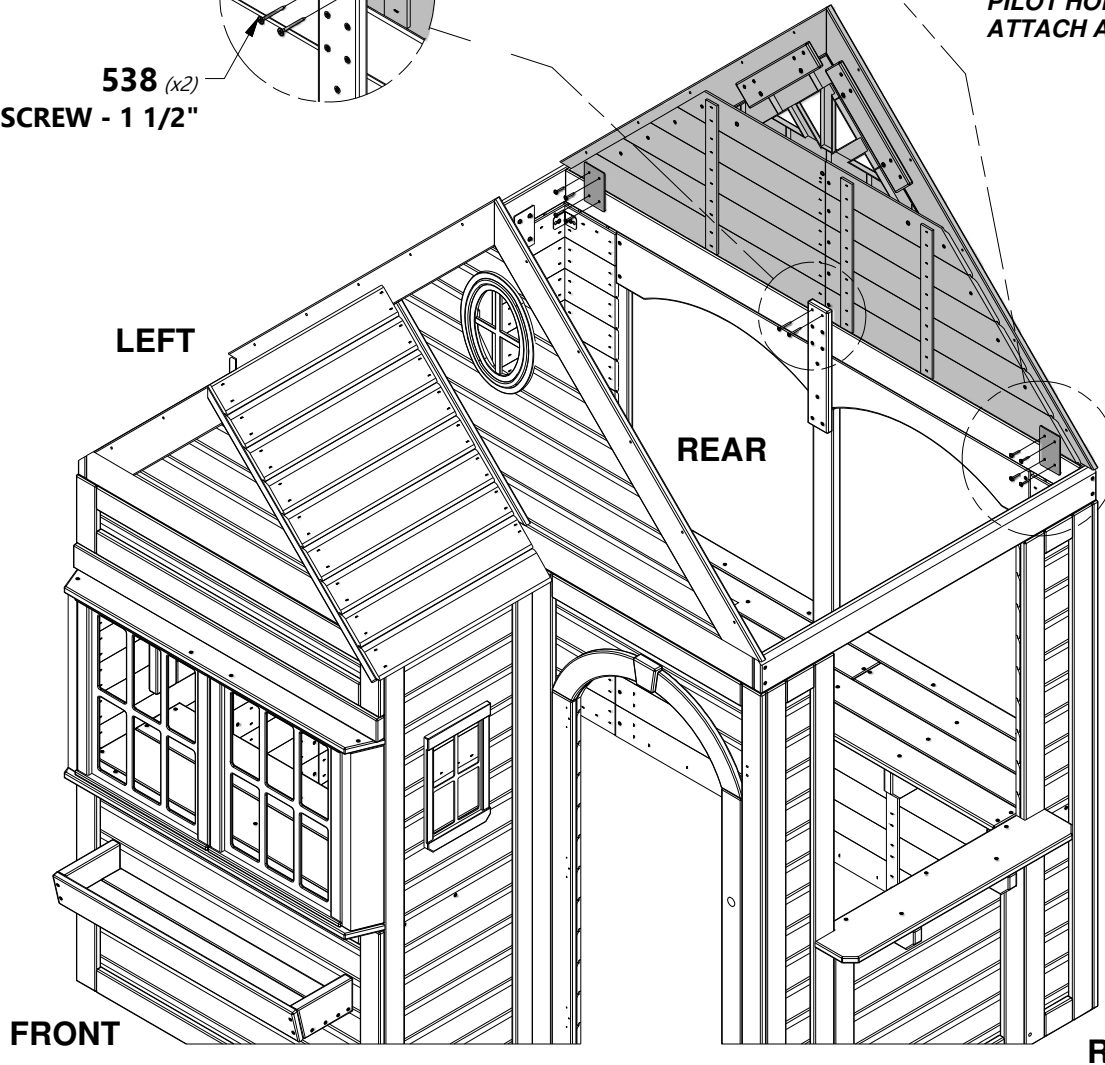

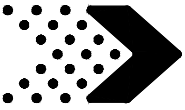

Phase 3

STEP 7

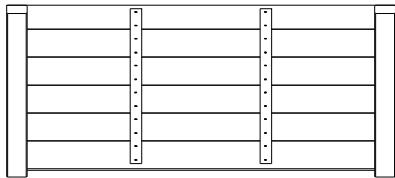

RP5 | ROOF PANEL - W2A02548
(x1) | 1 3/8"x19 5/8"x44 9/16" (35x499x1132)



H100538 | SCREW PFH SD
(x4) | 8x1 1/2"

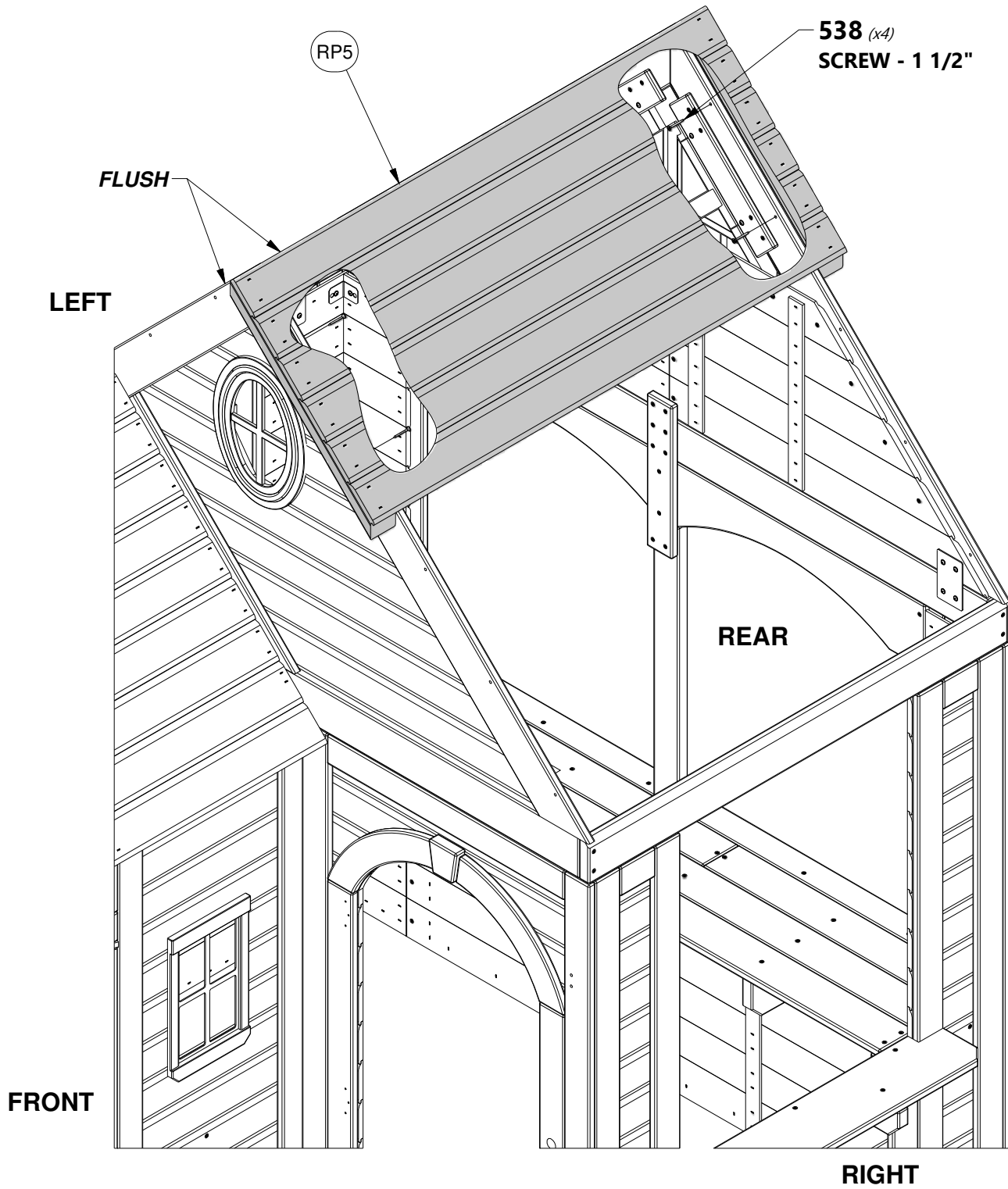

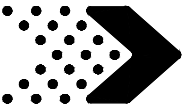

Phase 3

STEP 8

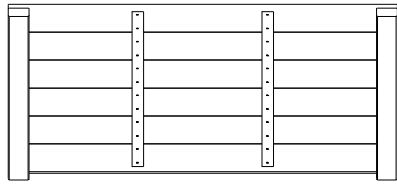

RP4 | ROOF PANEL - W2A02644
(x1) | 1 3/8"x20 1/16"x44 9/16" (35x510x1132)



H100538 | SCREW PFH SD
(x4) | 8x1 1/2

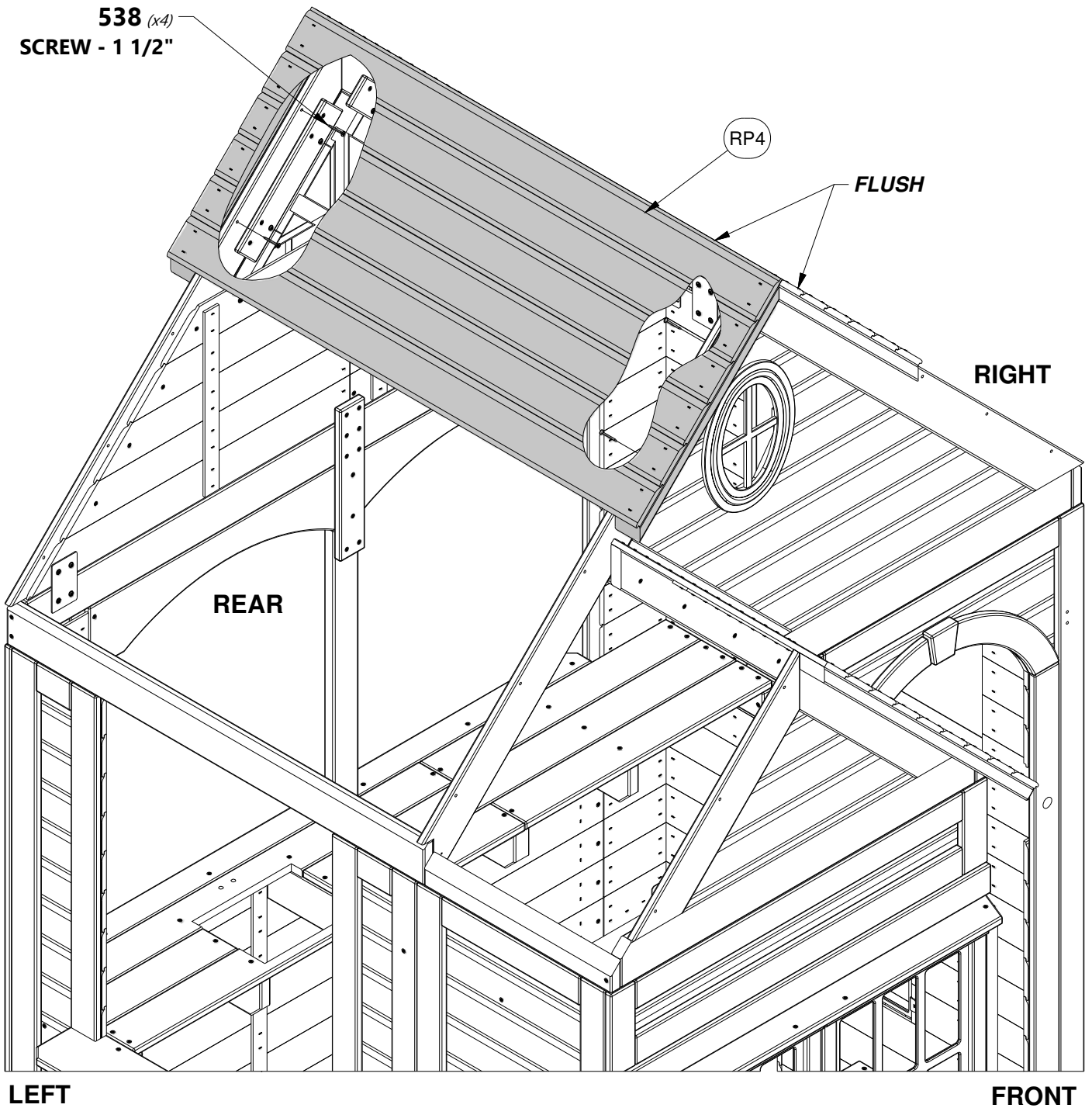

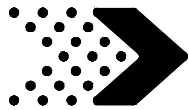

Phase 3

STEP 9

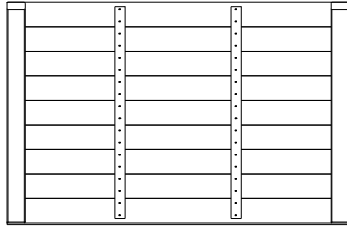

RP3 | ROOF PANEL - W2A02546
(x1) | 1 3/8"x28 7/8"x44 9/16" (35x734x1132)



H100538 | SCREW PFH SD
(x6) | 8x1 1/2

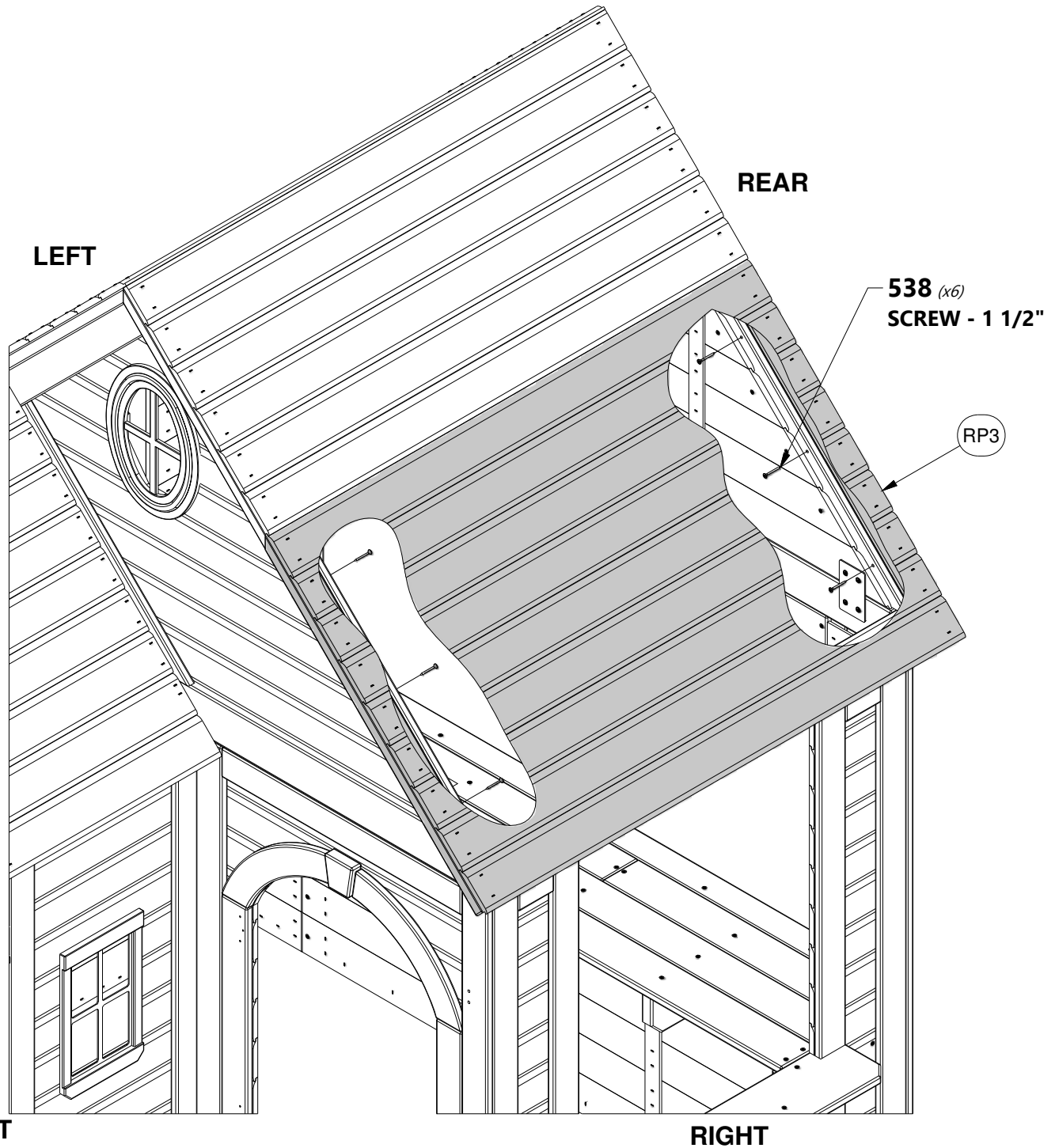

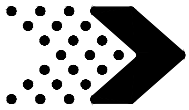

Phase 3

STEP 10

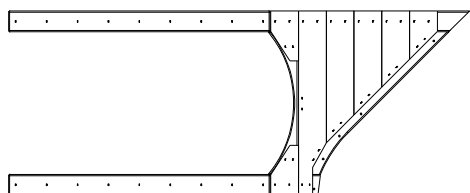

WP17 | WALL PANEL - W2A02364
(x1) 1 1/16"x21 1/16"x52 7/8" (27x535x1342)

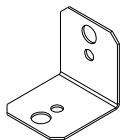

A4M00555 | 90° L-BRACKET - BLK
(x3)



H100392 | SCREW PWH BLK
(x6) 8x3/4

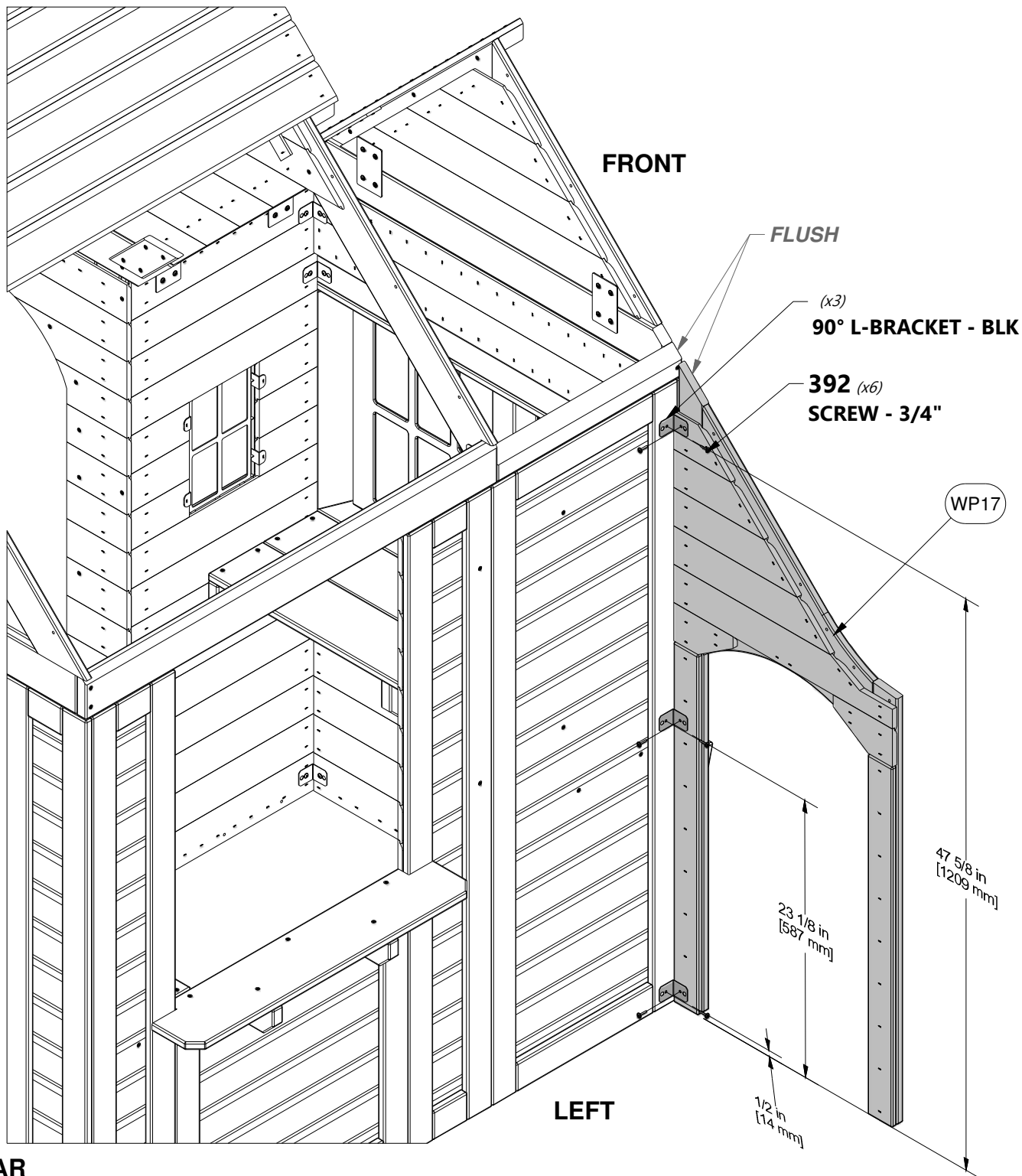

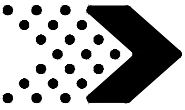

Phase 3

STEP 11

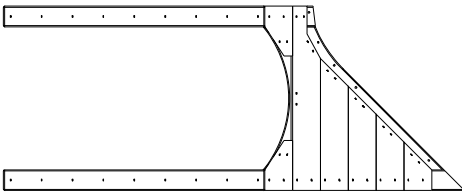

WP18 | WALL PANEL - W2A02633
(x1) | 1 1/16"x21 1/16"x52 7/8" (27x535x1342)

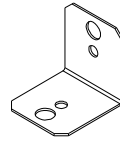

A4M00555 | 90° L-BRACKET - BLK
(x3)



H100392 | SCREW PWH BLK
(x6) | 8x3/4

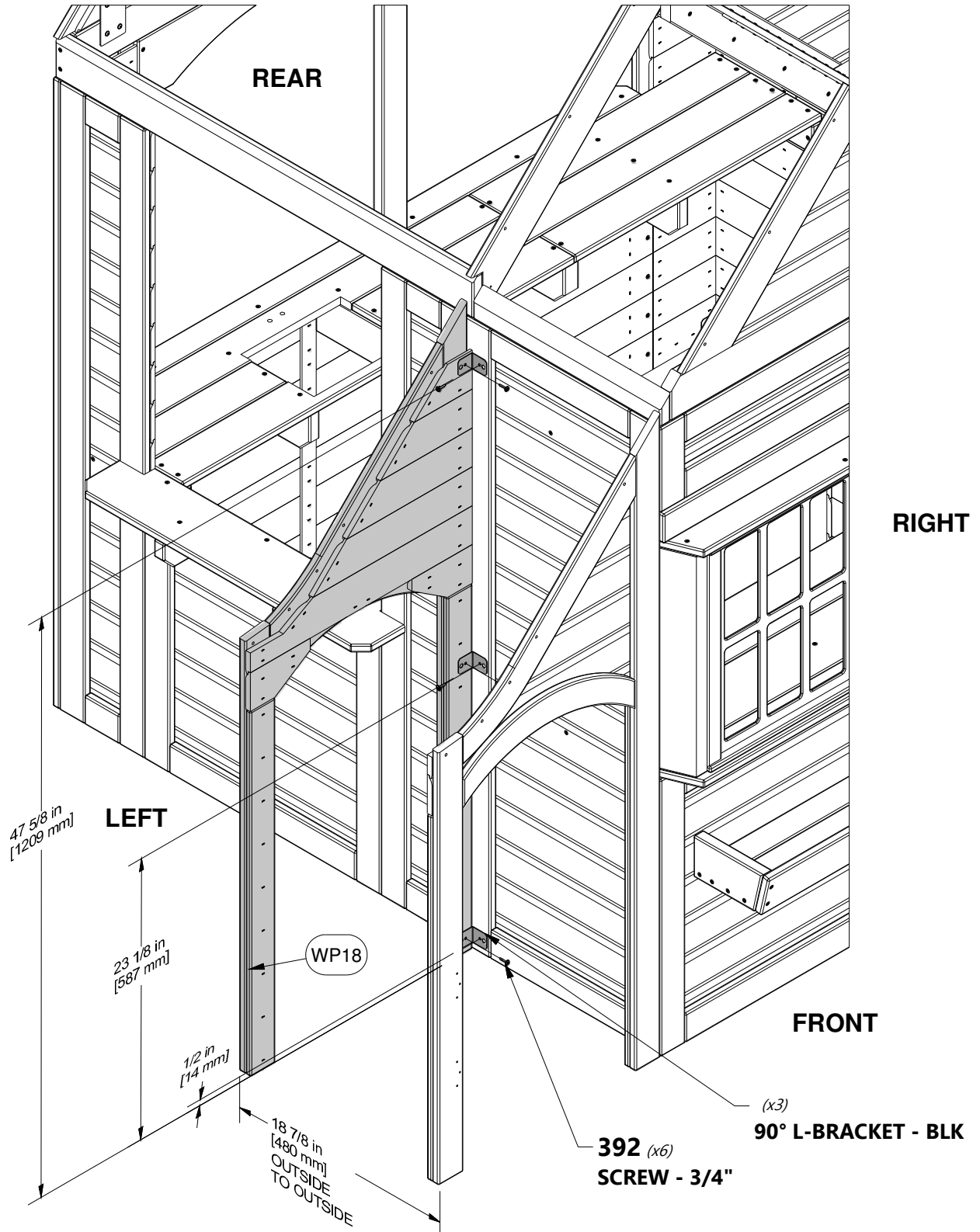

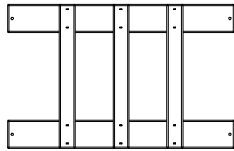
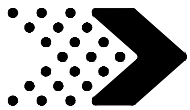

FP1 | FENCE PANEL - W2A02553
(x1) | 1 1/16"x12"x18 15/16" (27x305x481)



H100538 | SCREW PFH SD
(x4) | 8x1 1/2

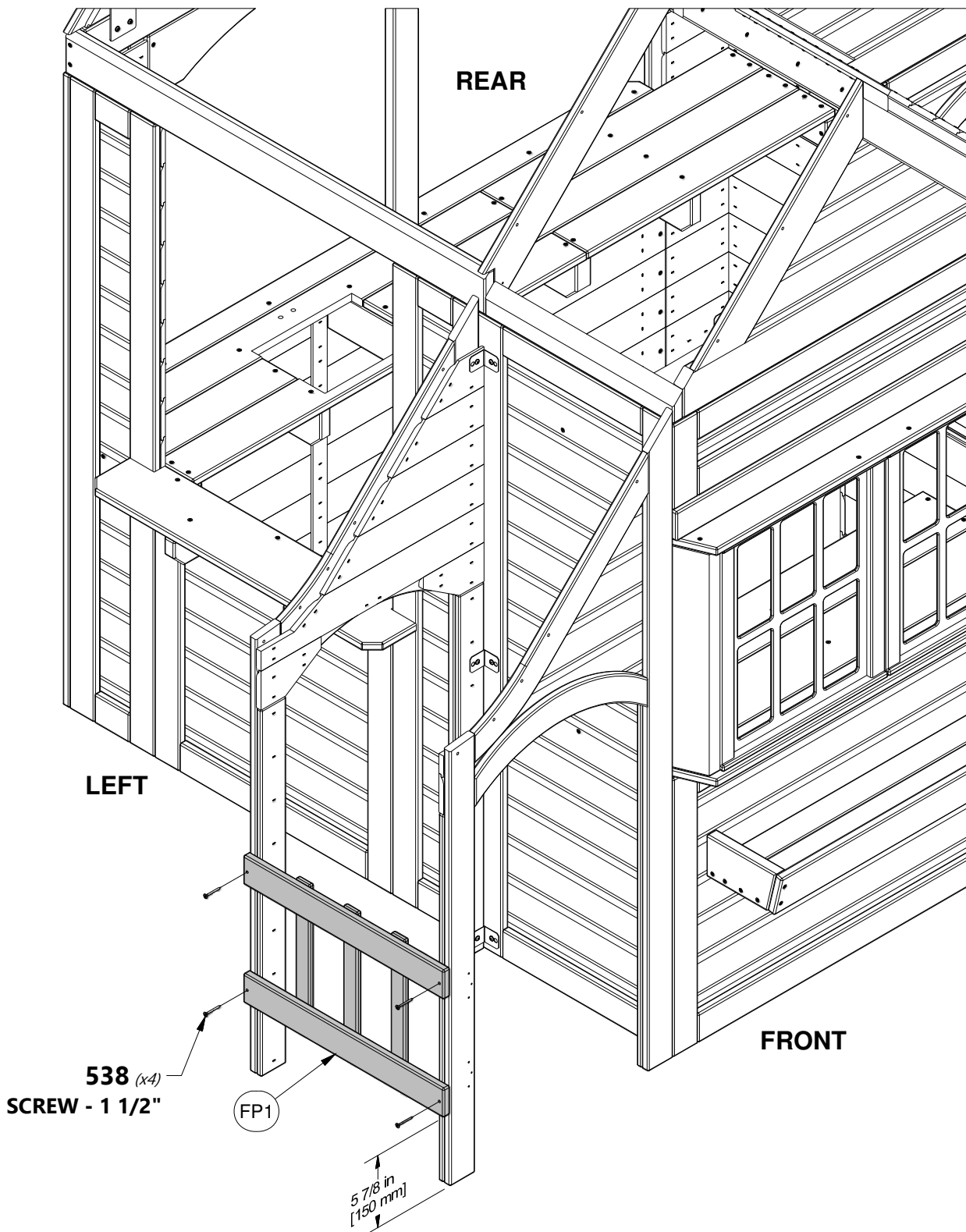



Phase 3

STEP 13

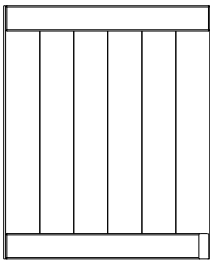

RP6 | ROOF PANEL - W2A02641
(x1) | 1 3/8"x19 3/8"x23 11/16" (35x491x602)

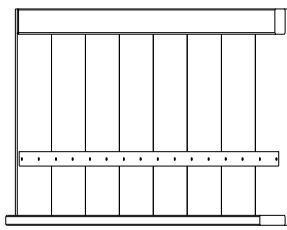

RP8 | ROOF PANEL - W2A02640
(x1) | 1 3/8"x20 1/4"x26 5/8" (71x515x675)



H100538 | SCREW PFH SD
(x11) | 8x1 1/2"

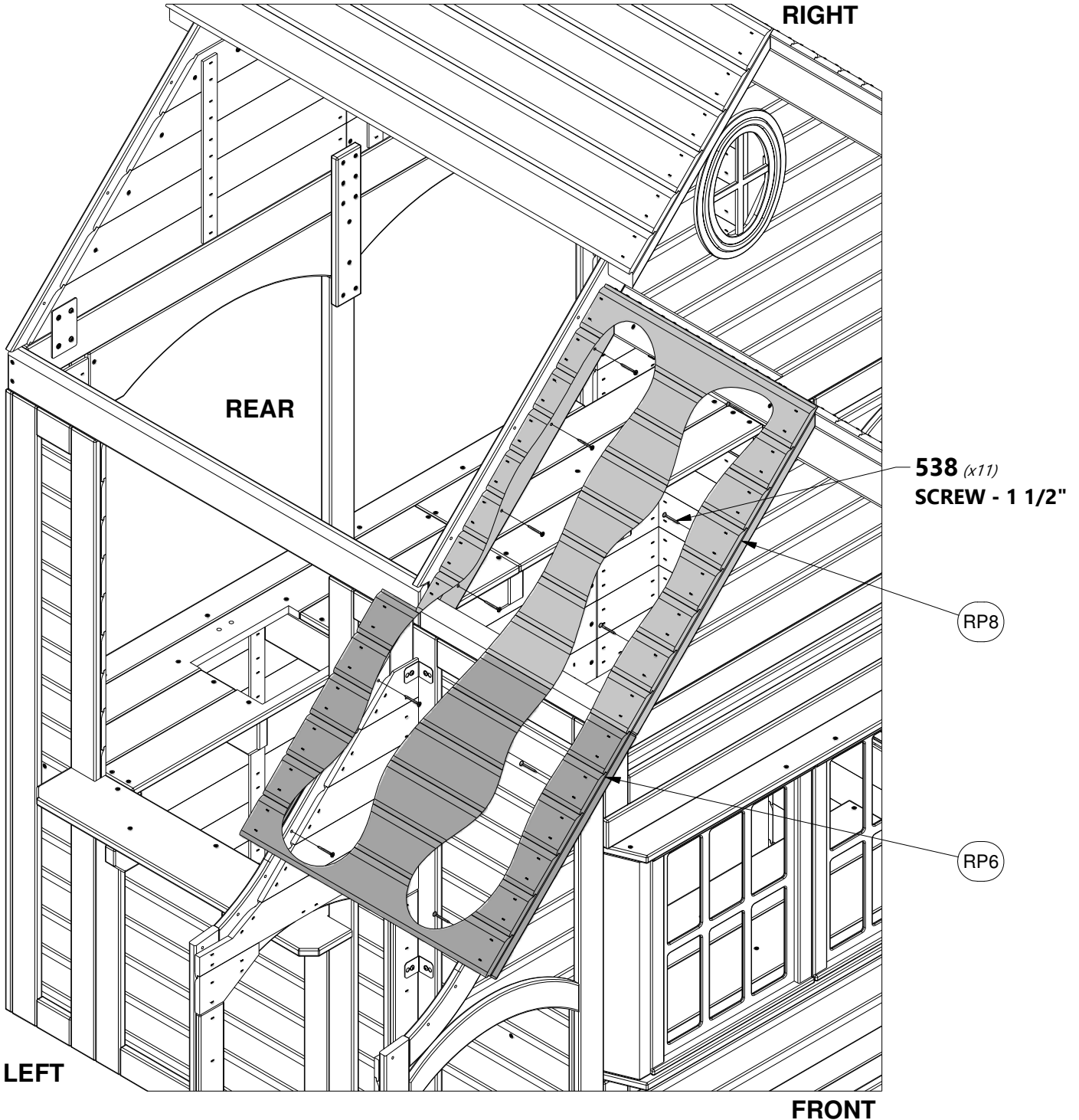

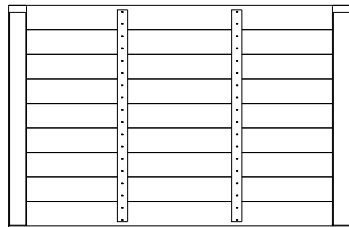
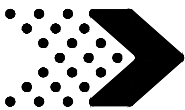

RP3 | ROOF PANEL - W2A02546
(x1) | 1 3/8"x28 7/8"x44 9/16" (35x734x1132)



H100538 | SCREW PFH SD
(x6) | 8x1 1/2

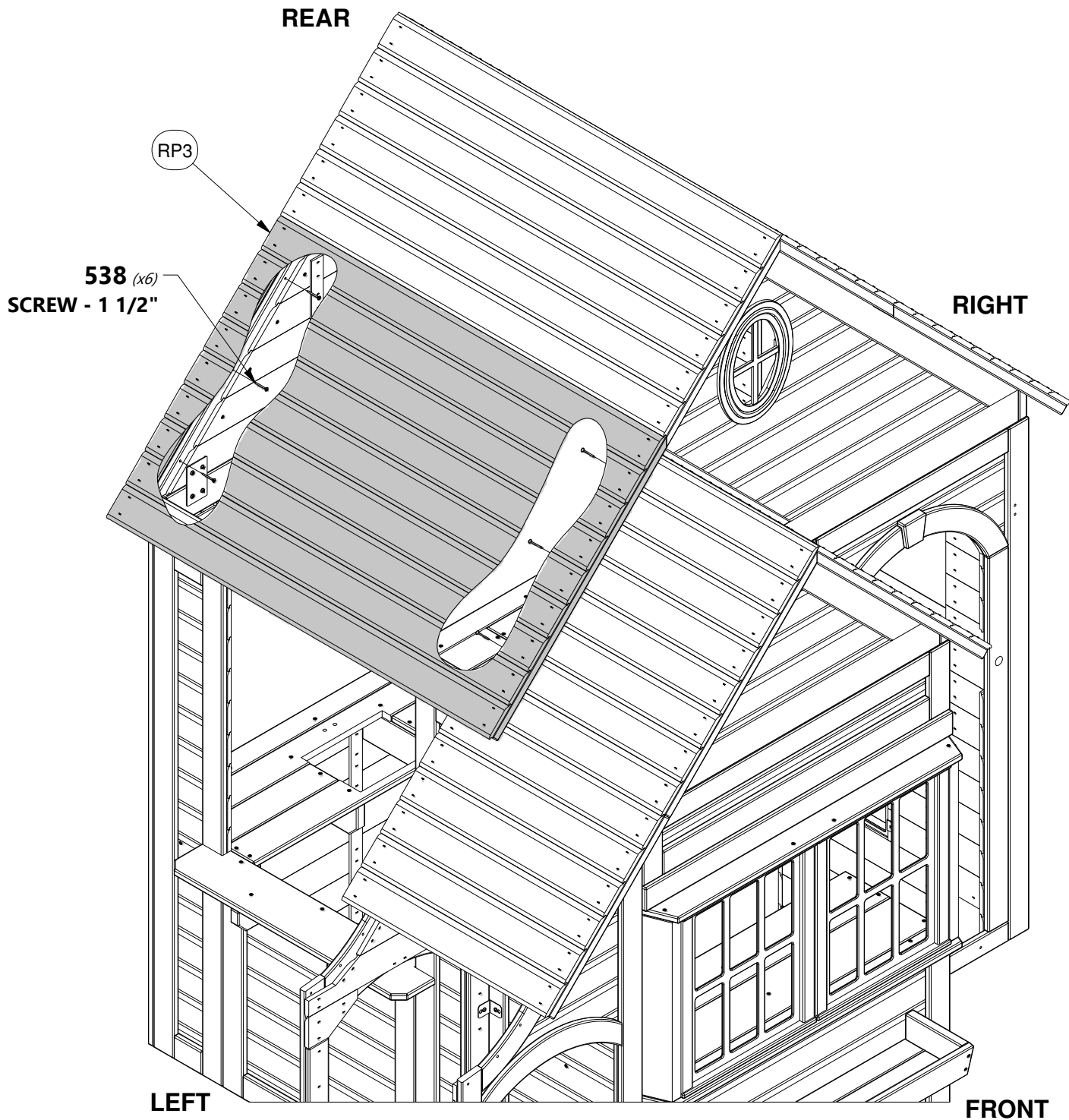



RP7 | ROOF PANEL - W2A02552
(3) | 1 3/8"x3 3/8"x23 11/16" (35x86x602)



H100538 | SCREW PFH SD
(x6) | 8x1 1/2

REAR

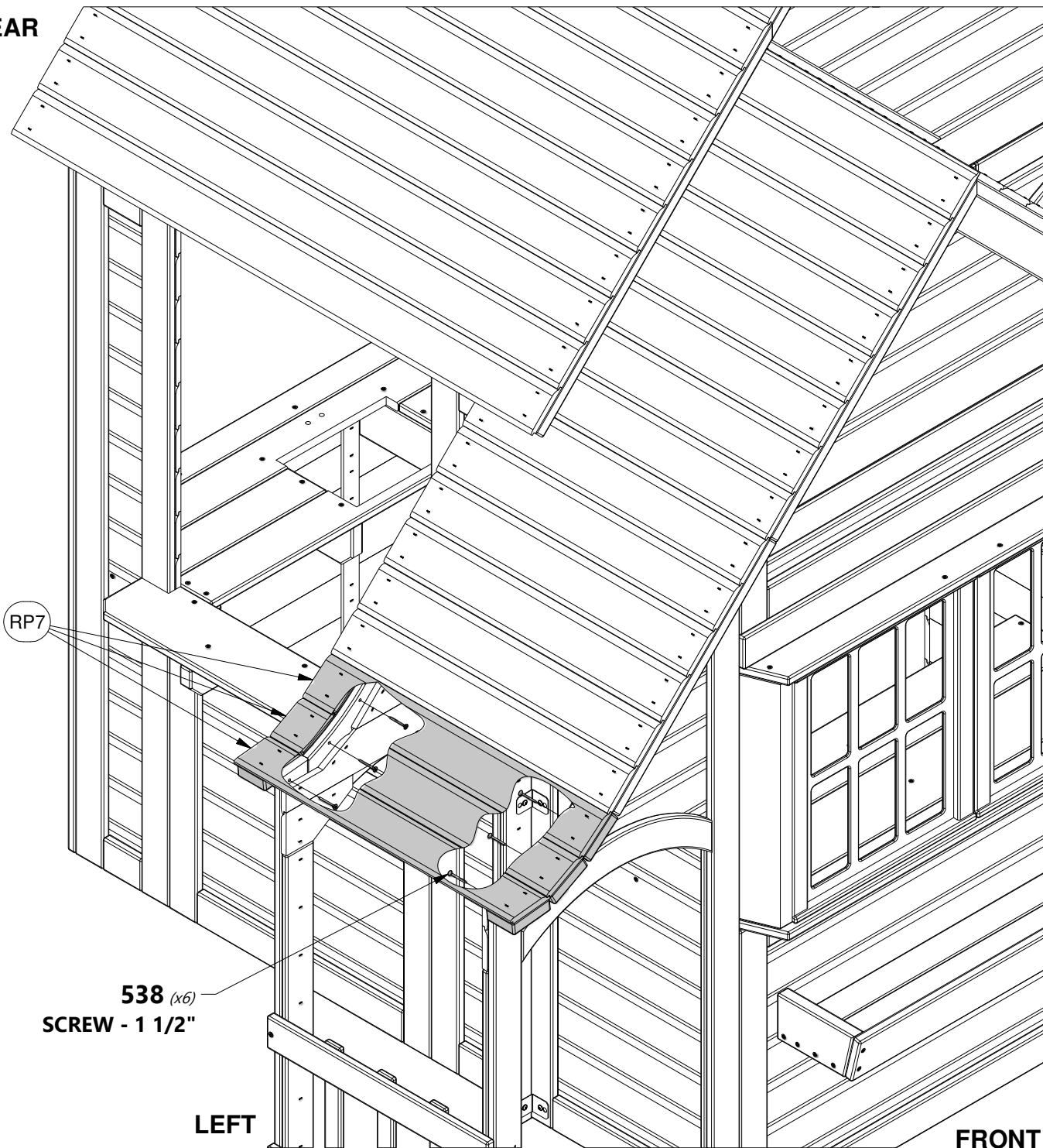

RP7

538 (x6)
SCREW - 1 1/2"

LEFT

FRONT

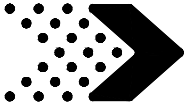

Phase 4

STEP 1



K3 | TRIM - W4L11680
(x1) | 5/8"x5 1/4"x18 15/16" (16x134x481)

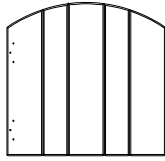

GP1 | GATE PANEL - W2A02554
(x1) | 1 1/16"x14 5/16"x14 7/8" (27x364x378)

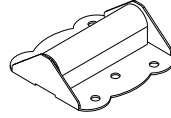

A4M00624 | HINGE (DOOR, SPRING LOADED)
(x1)

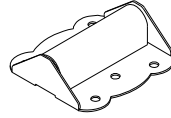

A4M00994 | HINGE (DOOR, NON-SPRING LOADED)
(x1)



H100538 | SCREW PFH SD
(x4) | 8x1 1/2



H100202 | SCREW PWH BLK
(x12) | 8x5/8

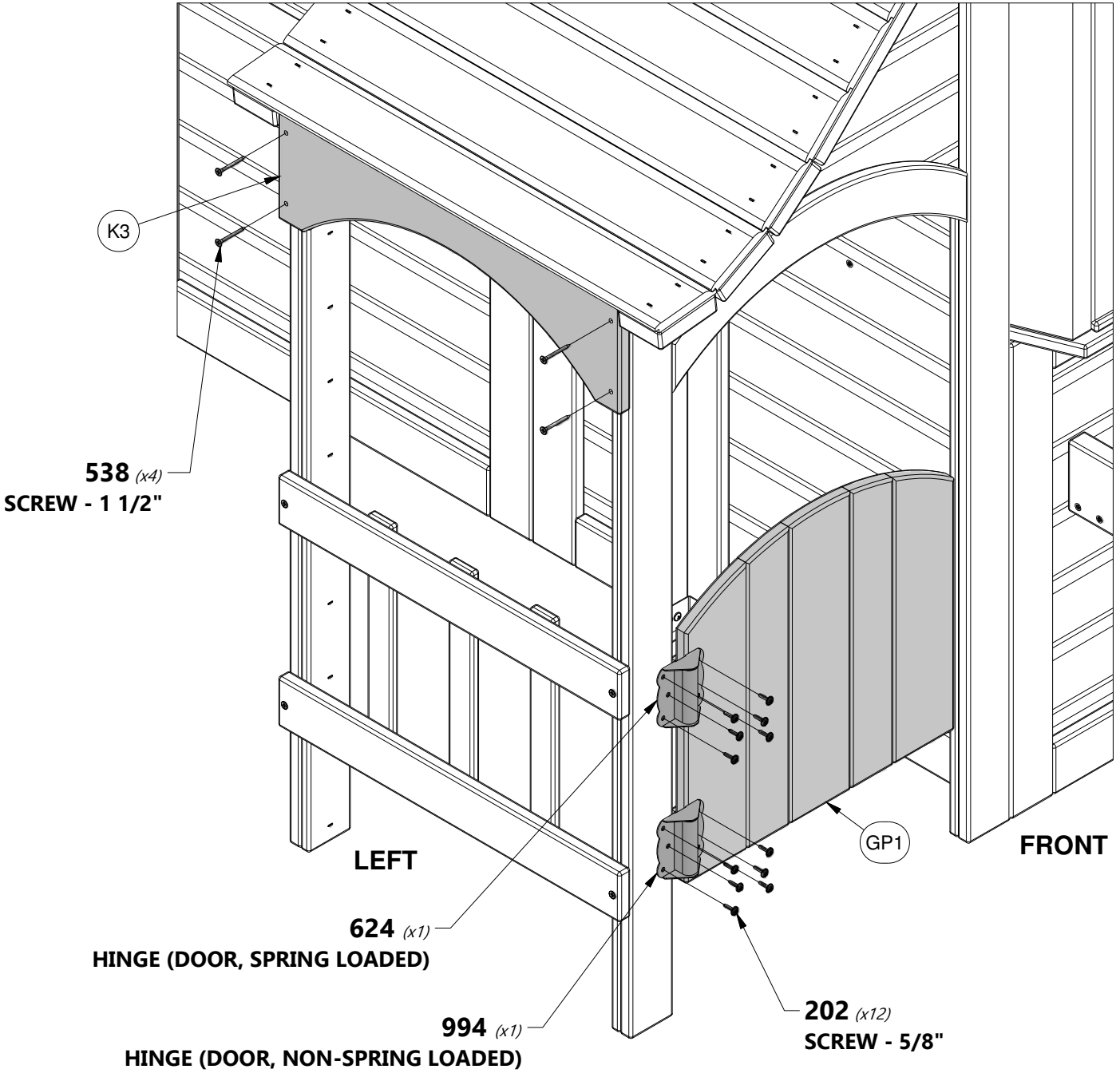

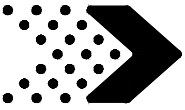

Phase 4

STEP 2

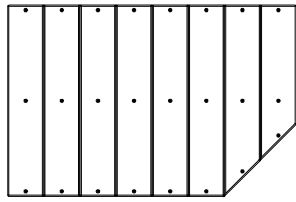

PP1 | PORCH PANEL - W2A02556
(x1) | 1 15/16"x17 15/16"x27 1/16" (50x455x688)



H100541 | SCREW PFH SD
(x3) | 8x1 3/4

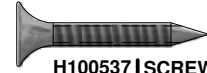

H100537 | SCREW PFH SD
(x3) | 8x1

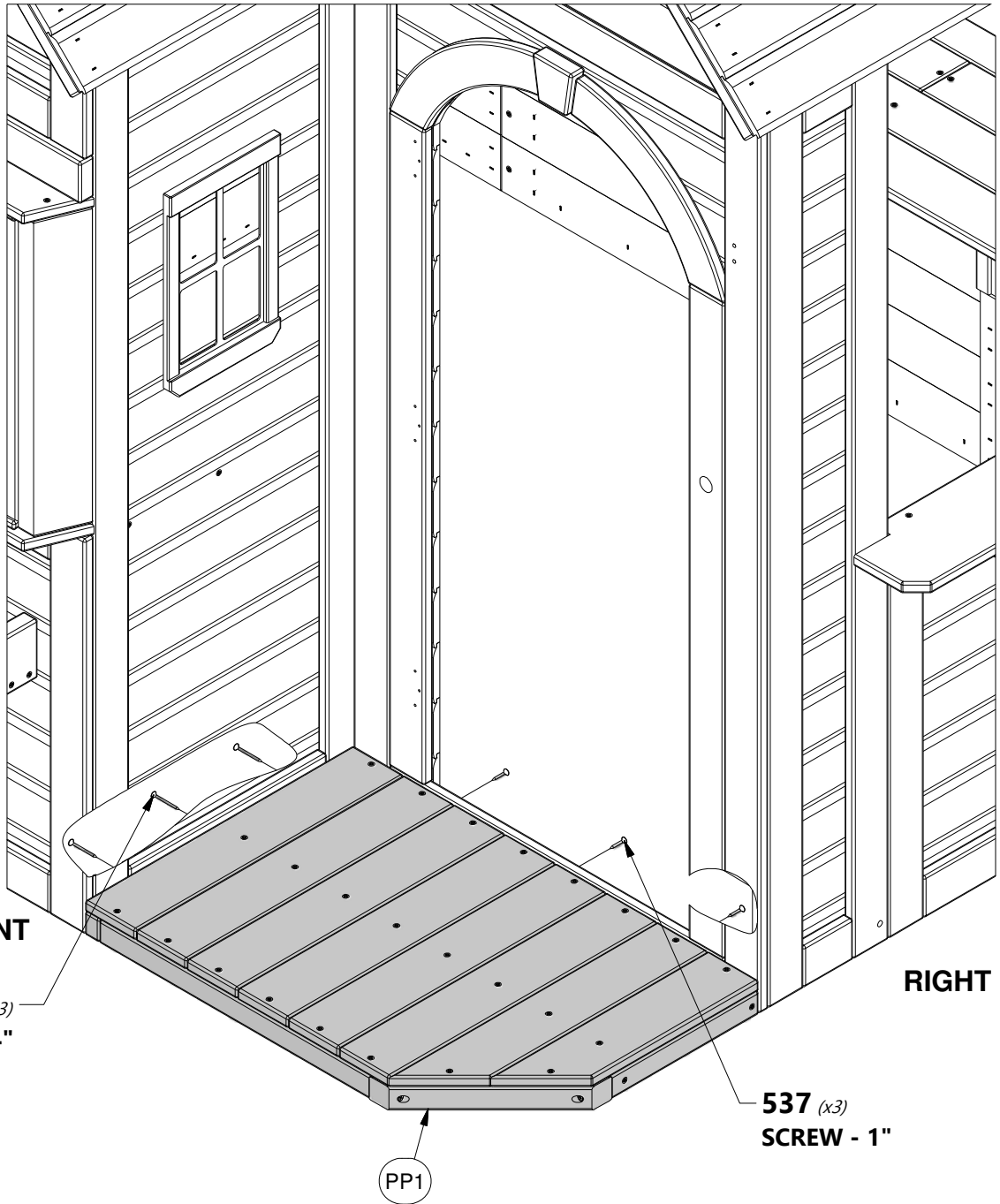

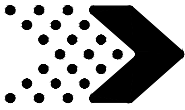

Phase 4

STEP 3

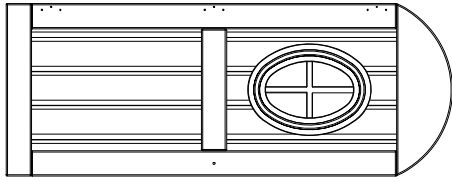

DP1 | DOOR PANEL - W2A02555
(x1) | 1 1/16"x16 1/8"x41 7/8" (27x410x1063)

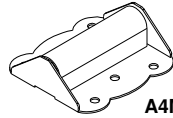

A4M00624 | HINGE (DOOR, SPRING LOADED)
(x2)

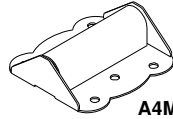

A4M00994 | HINGE (DOOR, NON-SPRING LOADED)
(x1)



H100202 | SCREW PWH BLK
(x18) | 8x5/8

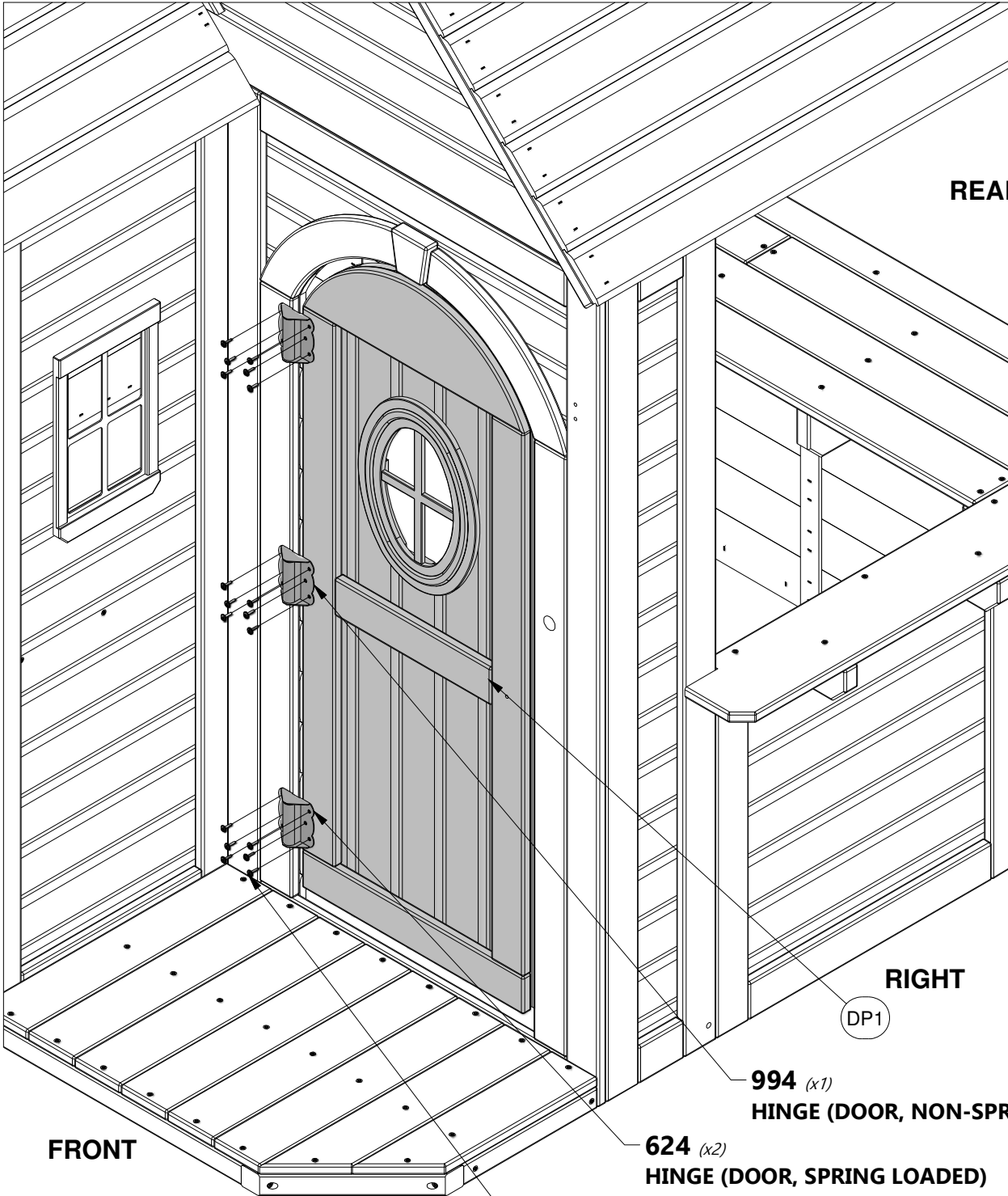

FRONT

REAR

RIGHT

DP1

994 (x1)
HINGE (DOOR, NON-SPRING LOADED)

624 (x2)
HINGE (DOOR, SPRING LOADED)

202 (x18)
SCREW - 5/8"

NOTE:
PILOT HOLES FOR HINGE PLACEMENT.

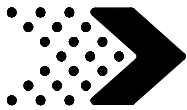

Phase 4

STEP 4

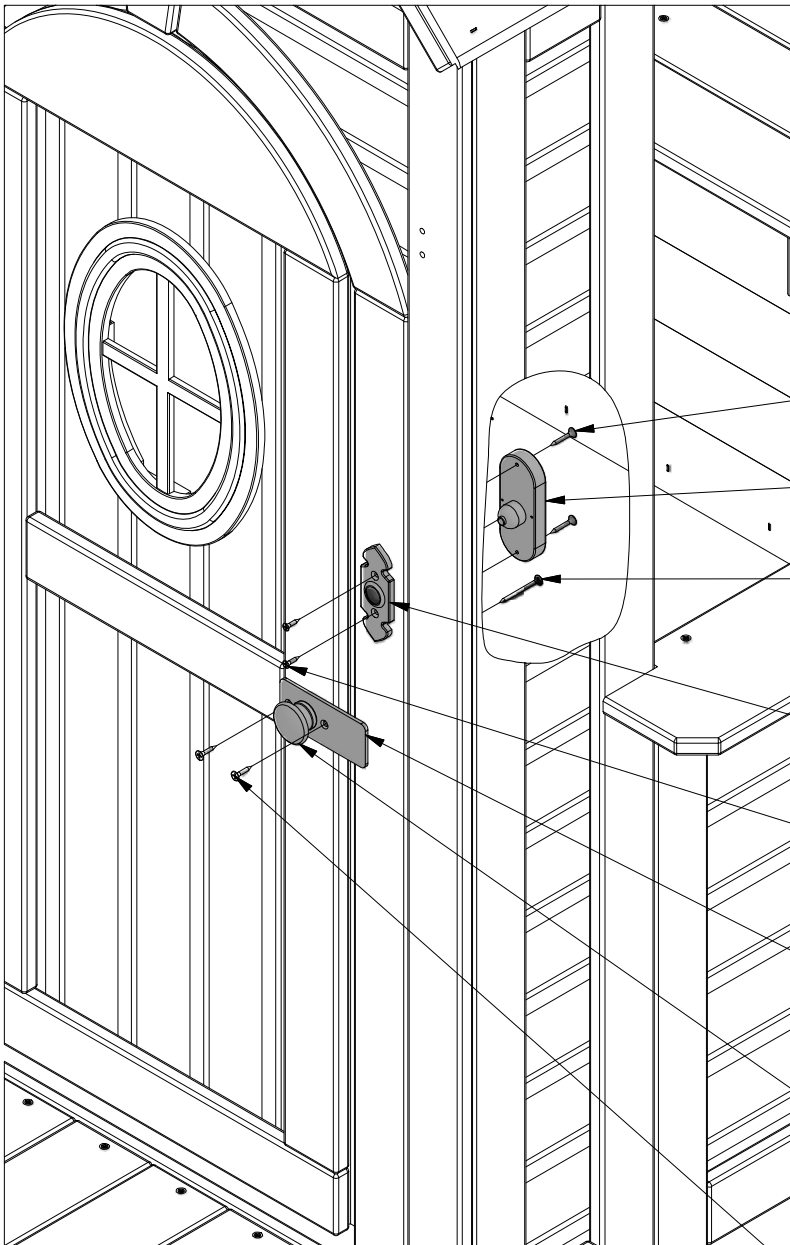
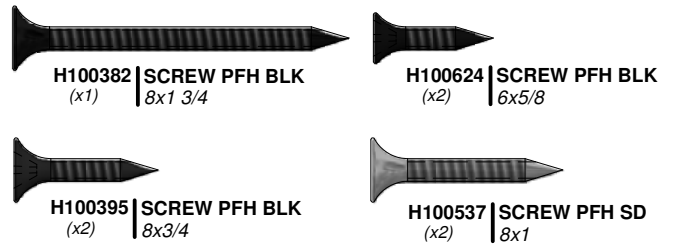
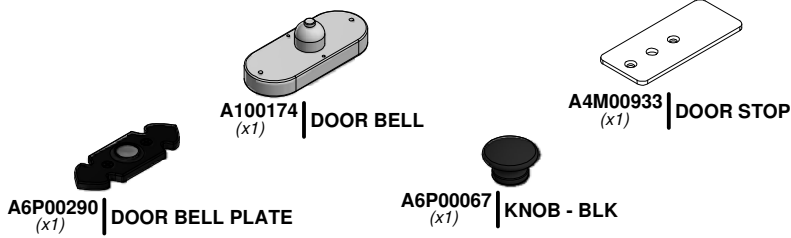
**NOTE:**

THIS DEVICE COMPLIES WITH PART 15 OF THE FCC RULES. OPERATION IS SUBJECT TO THE FOLLOWING TWO CONDITIONS: (1) THIS DEVICE MAY NOT CAUSE HARMFUL INTERFERENCE, (2) THIS DEVICE MUST ACCEPT ANY INTERFERENCE RECEIVED, INCLUDING INTERFERENCE THAT MAY CAUSE UNDESIRABLE OPERATION.

NOTE:

- DO NOT MIX OLD AND NEW BATTERIES.
- DO NOT MIX ALKALINE, STANDARD (CARBON-ZINC), OR RECHARGEABLE (NI-CAD, NI-MH, ETC.) BATTERIES.
- NON-RECHARGEABLE BATTERIES ARE NOT TO BE RECHARGED.
- ONLY BATTERIES OF THE SAME OR EQUIVALENT TYPE AS RECOMMENDED ARE TO BE USED.
- BATTERIES ARE TO BE INSERTED WITH THE CORRECT POLARITY.
- EXHAUSTED BATTERIES ARE TO BE REMOVED FROM THE TOY OR IF THE TOY IS TO BE LEFT UNUSED FOR A LONG TIME.
- THE SUPPLY TERMINALS ARE NOT TO BE SHORT-CIRCUITED.
- RECHARGEABLE BATTERIES ARE TO BE REMOVED FROM THE TOY BEFORE BEING CHARGED.
- RECHARGEABLE BATTERIES ARE ONLY TO BE CHARGED UNDER ADULT SUPERVISION.

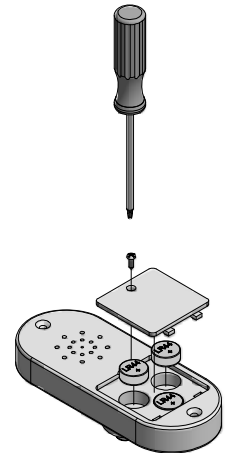
RIGHT**537 (x2)****SCREW - 1"****174 (x1)****DOOR BELL****382 (x1)****SCREW - 1 3/4"****290 (x1)****DOOR BELL PLATE****624 (x2)****SCREW - 5/8"****933 (x1)****DOOR STOP****067 (x1)****KNOB - BLK****395 (x2)****SCREW - 3/4"****NOTE:**

USING A SCREW DRIVER, REPLACE BATTERIES BY REMOVING SCREW IN BATTERY COVER, REMOVING BATTERY COVER AND FOLLOWING DIRECTIONS FOR BATTERY REPLACEMENT LOCATED ON THE BATTERY COVER.

**FRONT****WARNING:**

1. KEEP BATTERIES OUT OF THE REACH OF CHILDREN.
2. SWALLOWING MAY LEAD TO SERIOUS INJURY OR DEATH IN AS LITTLE AS 2 HOURS, DUE TO CHEMICAL BURNS AND POTENTIAL PERFORATION OF THE ESOPHAGUS.
3. IF YOU SUSPECT YOUR CHILD HAS SWALLOWED A BUTTON BATTERY, IMMEDIATELY SEEK URGENT MEDICAL ASSISTANCE.
4. EXAMINE DEVICES AND MAKE SURE THE BATTERY COMPARTMENT IS CORRECTLY SECURED, E.G. THAT THE SCREW OR OTHER MECHANICAL FASTENER IS TIGHTENED. DO NOT USE IF COMPARTMENT IS NOT SECURE.
5. DISPOSE OF USED BUTTON BATTERIES IMMEDIATELY AND SAFELY. FLAT BATTERIES CAN STILL BE DANGEROUS.
6. TELL OTHER OF THE RISK ASSOCIATED WITH BUTTON BATTERIES AND HOW TO KEEP THEIR CHILDREN SAFE.

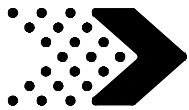

Phase 4

STEP 5

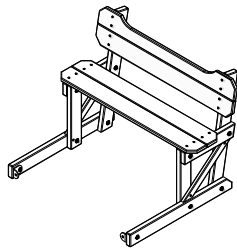

(1) BENCH ASSEMBLY FROM BENCH PHASE

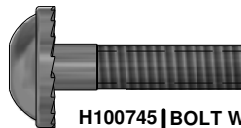

H100745 | BOLT WH SD (x2) 1/4x1

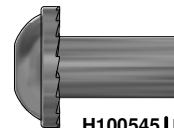

H100545 | NUT BARREL WH SD (x2) 1/4x5/8

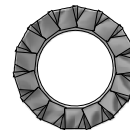

H100547 | WASHER LOCK EXT SD (x2) 8x15

545 (x2) NUT BARREL - 5/8"

547 (x2) WASHER - 8x15

745 (x2) BOLT - 1"

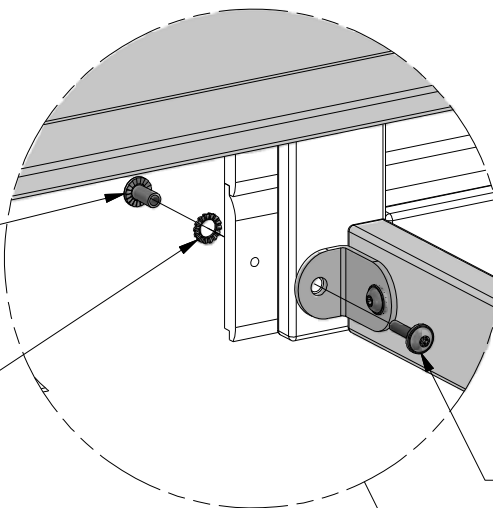

LEFT

REAR

FRONT

RIGHT

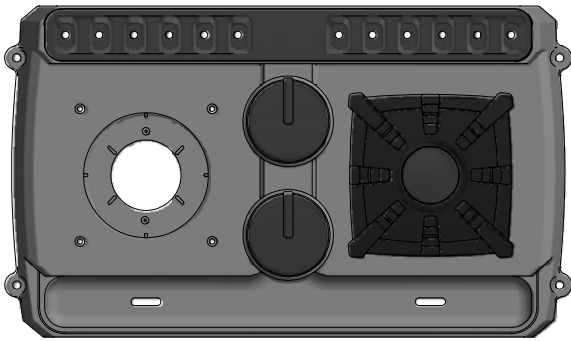
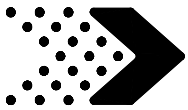

A6P00335 (x1) | STOVE BASE

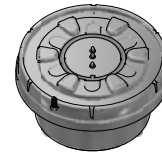

A6P00330 (x1) | INDUCTIVE BURNER KIT

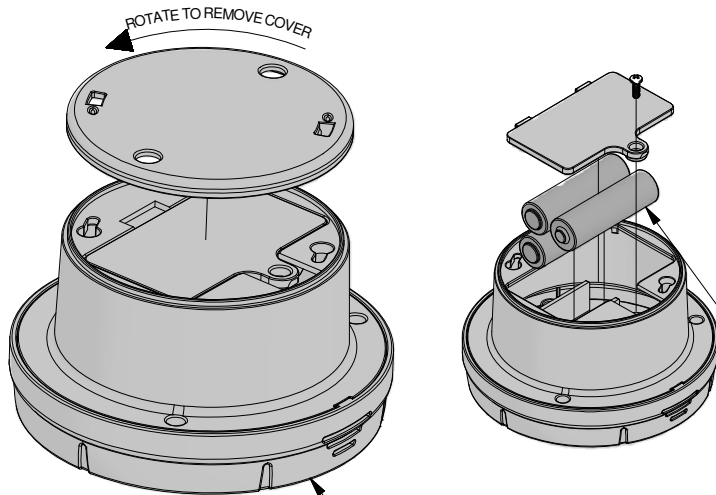

330 (x1) INDUCTIVE BURNER KIT



NOTE:

- ALWAYS WASH TOYS BEFORE USE.
- REMOVE THE FIRST COVER BY TWISTING IT COUNTER CLOCKWISE. REMOVE THE BATTERY COVER AND INSTALL THE BATTERIES (NOT INCLUDED). PUT THE BATTERY COVER BACK ON AND CONTINUE TO THE NEXT DIAGRAM.
- DO NOT MIX OLD AND NEW BATTERIES
- DO NOT MIX ALKALINE, STANDARD (CARBON-ZINC), OR RECHARGEABLE (NI-CAD, NI-MH, ECT.) BATTERIES.

"AA" BATTERY (x3)
(Not Included)

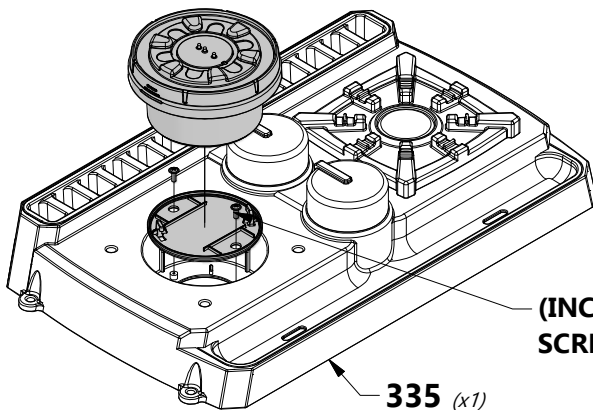

(INCLUDED WITH KIT) (x2) SCREW PWH 4x5/16

335 (x1) STOVE BASE



NOTE:

FIRST INSTALL THE COVER REMOVED ABOVE WITH THE INCLUDED HARDWARE. INSTALL THE BURNER BY TWISTING IT CLOCKWISE TO LOCK IT IN PLACE.



NOTE:

THIS DEVICE COMPLIES WITH PART 15 OF THE FCC RULES. OPERATION IS SUBJECT TO THE FOLLOWING TWO CONDITIONS: (1) THIS DEVICE MAY NOT CAUSE HARMFUL INTERFERENCE, (2) THIS DEVICE MUST ACCEPT ANY INTERFERENCE RECEIVED, INCLUDING INTERFERENCE THAT MAY CAUSE UNDESIRABLE OPERATION.

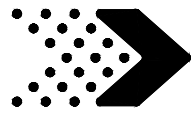

Phase 4

STEP 7

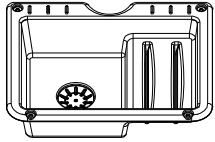

A6P00332 | PREMIUM SINK
(x1)

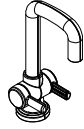

A6P00333 | FAUCET
(x1)

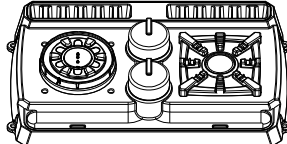

A6P00335 | STOVE BASE
(x1)

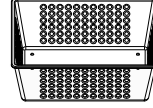

A6P00069 | FRUIT BASKET KIT
(x1)



H100537 | SCREW PFH SD
(x2) | 8x1



H100544 | SCREW PWH SD
(x12) | 8x5/8

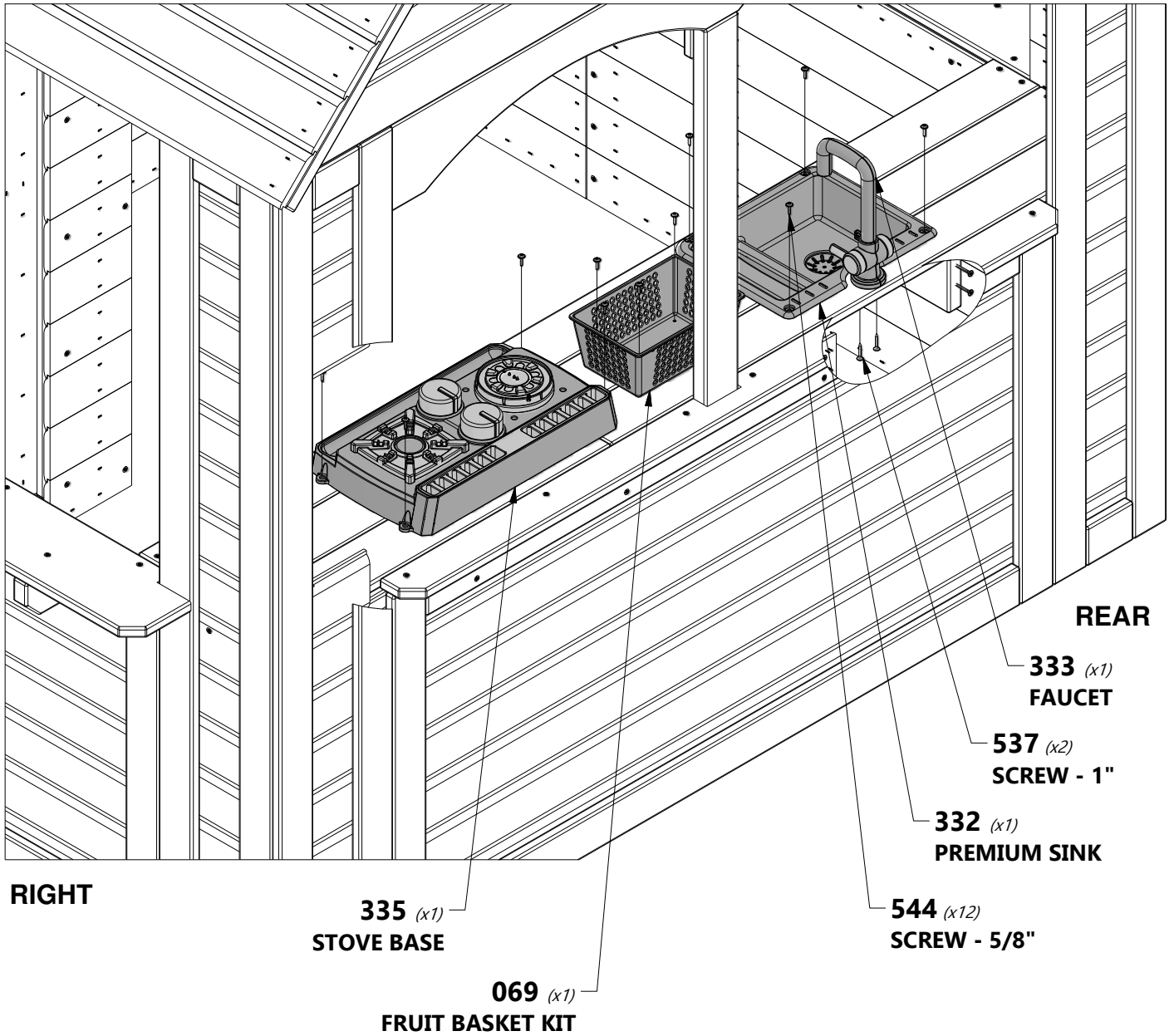

TIP:
APPROXIMATE LOCATION OF STOVE & FRUIT BASKET.

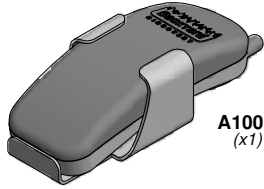
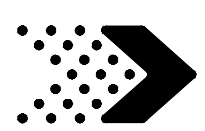

A100132 | PHONE KIT
(x1)



H100543 | SCREW PFH SD
(x2) | 8x1/2

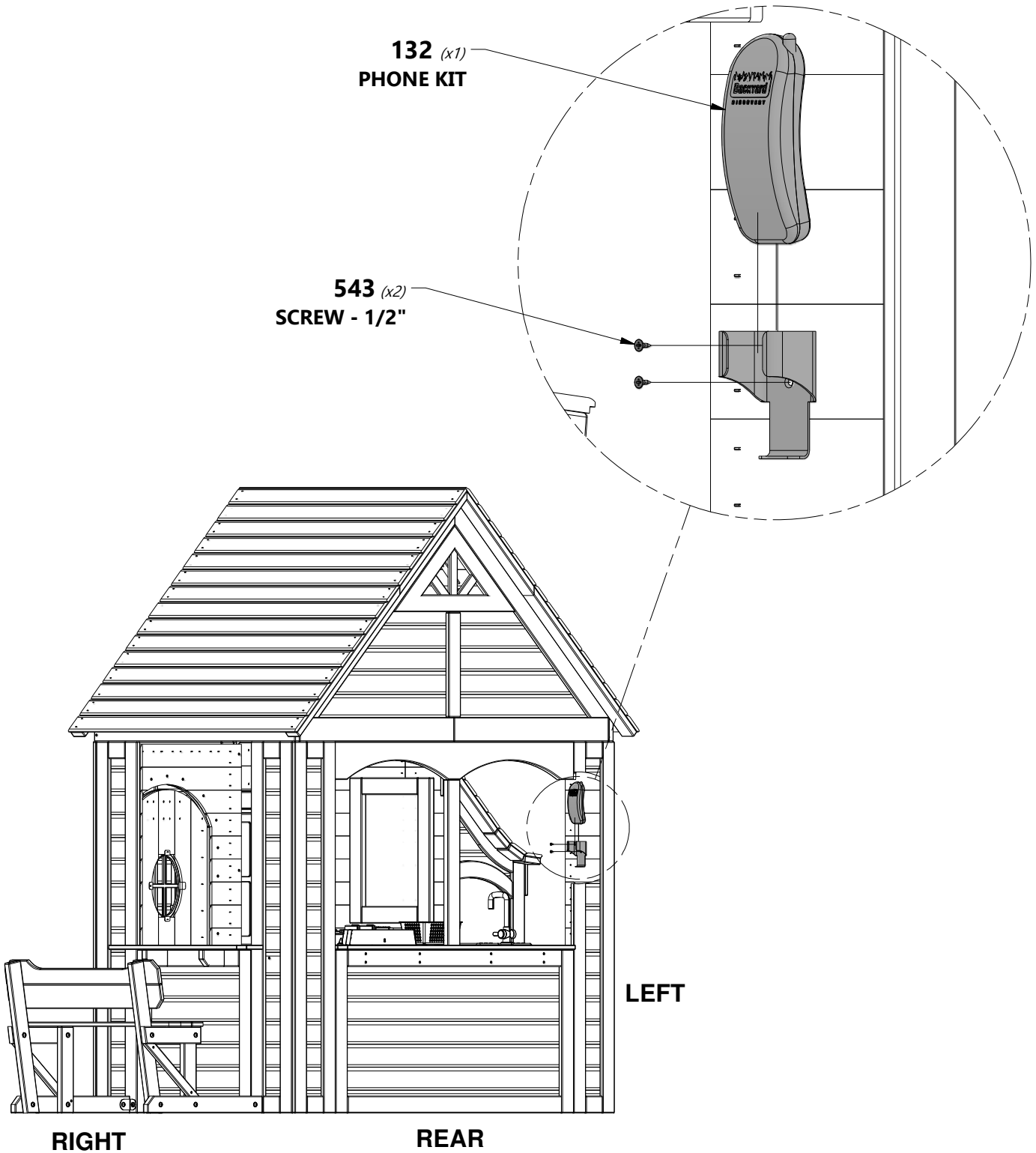

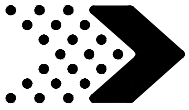

A4M00528 (x1) | BYD ID TAG (MEDIUM) AGES 2 TO 10



H100543 (x2) | SCREW PFH SD 8x1/2

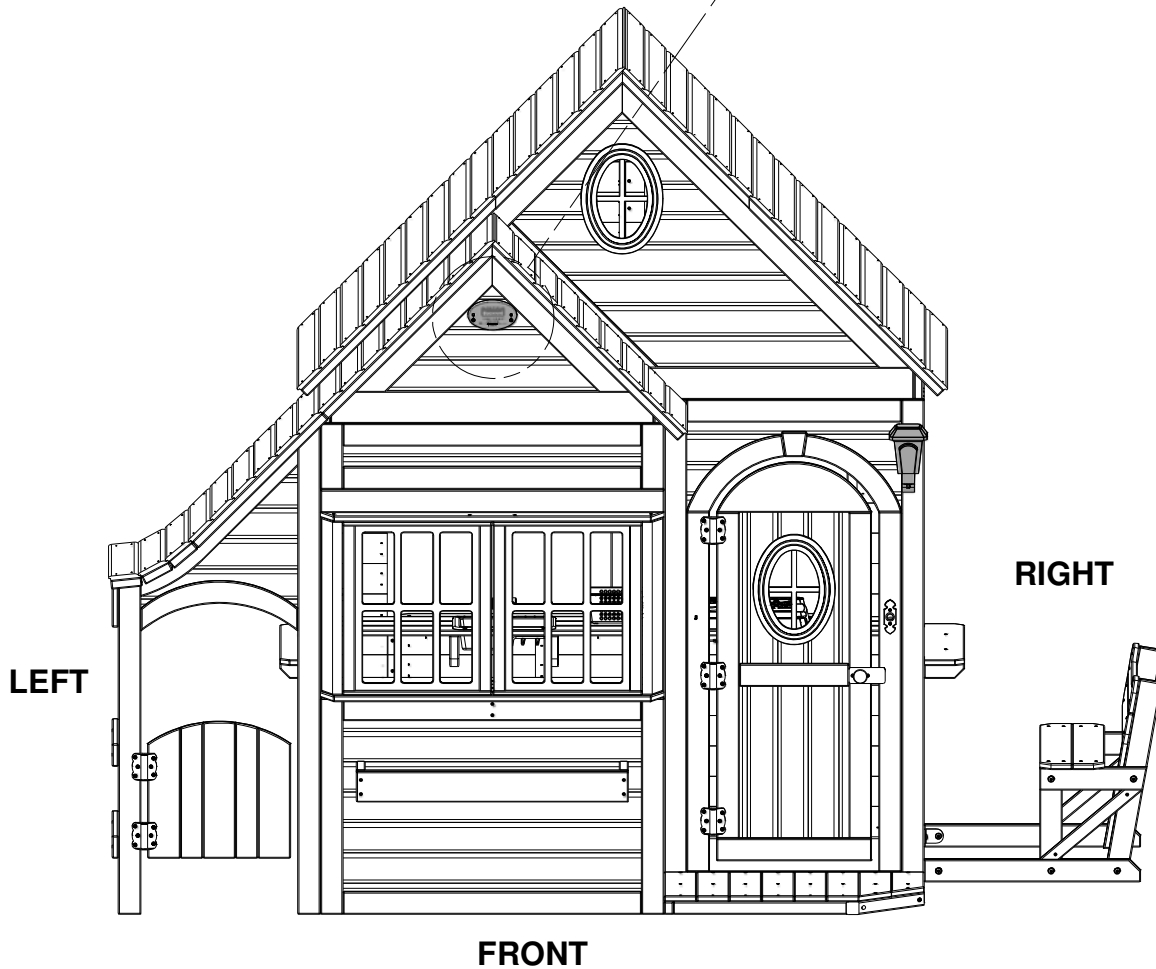
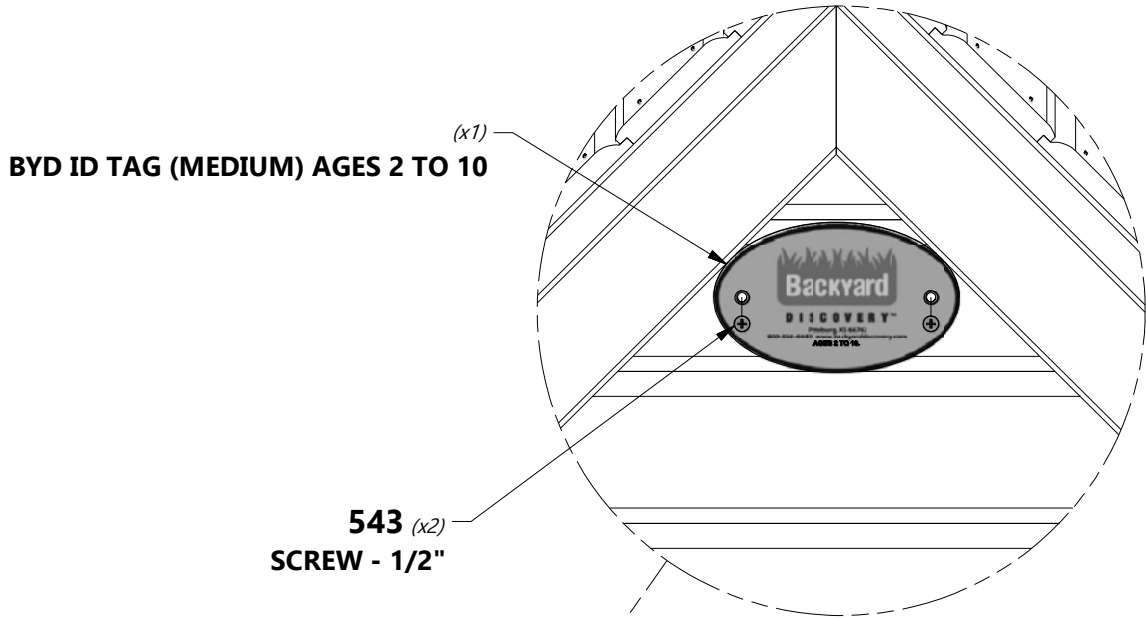

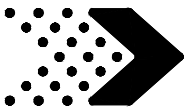

A6P00068 (x1) | OUTDOOR LIGHT FIXTURE



H100541 | SCREW PFH SD
(x2) | 8x1 3/4

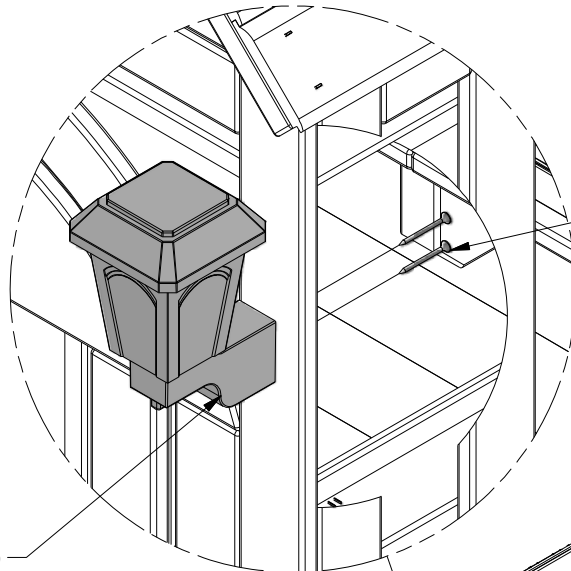

541 (x2)
SCREW - 1 3/4"

068 (x1)
OUTDOOR LIGHT FIXTURE

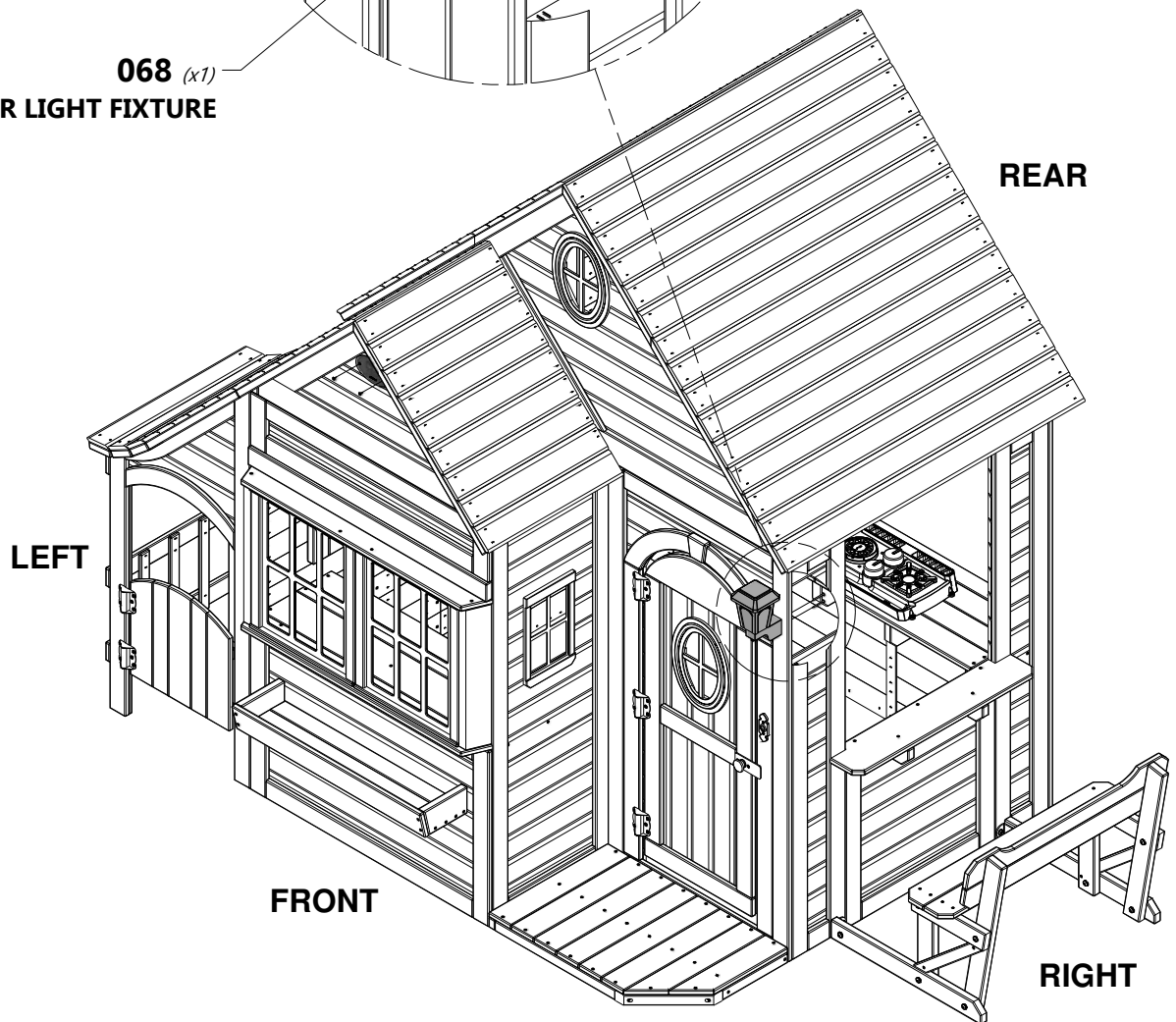

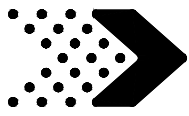

A100314 (x1) "A" REVISION TAG



H100392 (x2) SCREW PWH BLK 8x3/4

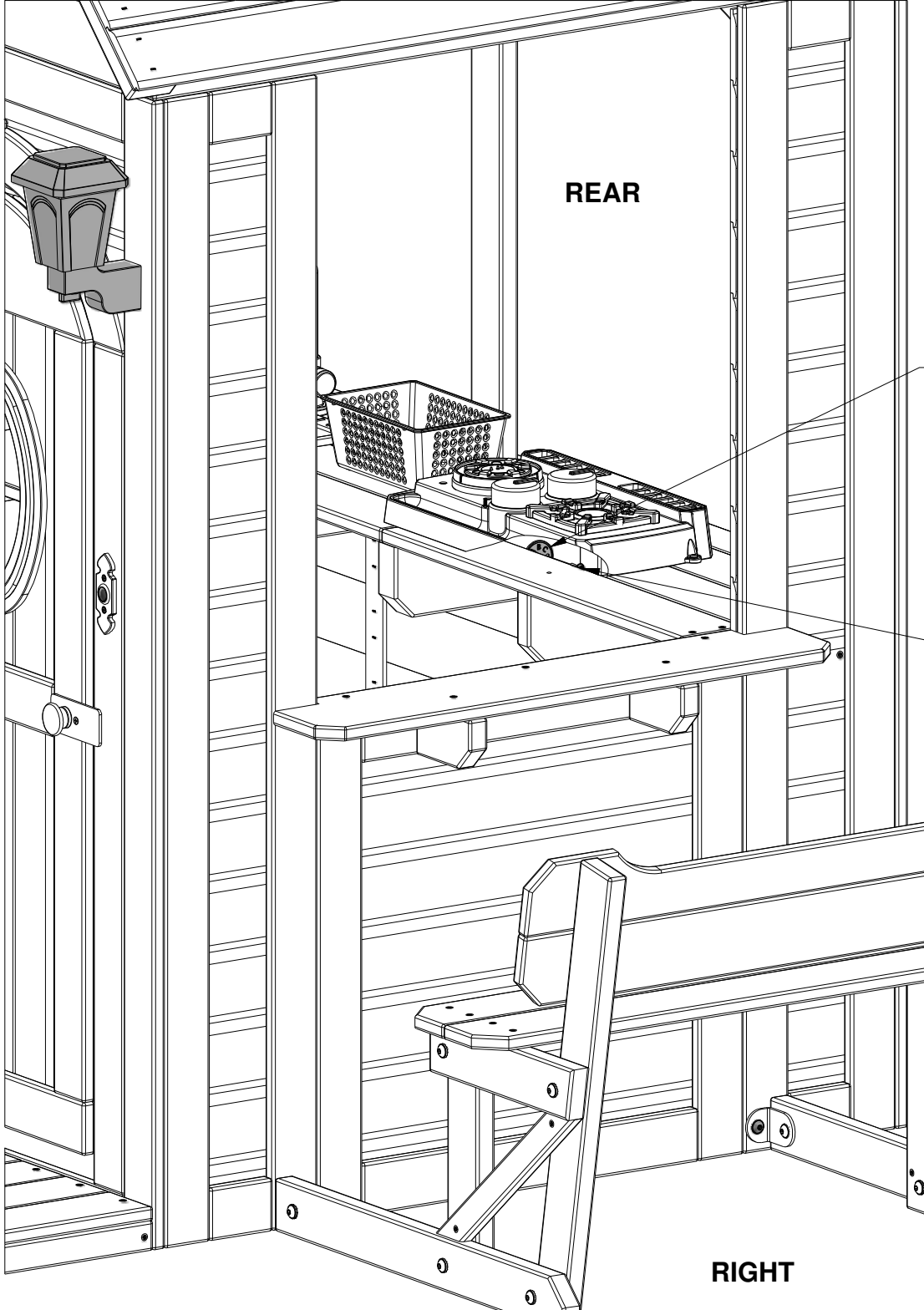

314 (x1) "A" REVISION TAG

392 (x2) SCREW - 3/4"

FRONT

REAR

RIGHT

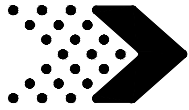

H12 | SUPPORT - W4L12661
(x1) | 15/16"x3 3/8"x7 7/8" (24x86x200)



P1 | POST - W4L12662
(x1) | 1 7/16"x1 7/16"x4 3/4" (36x36x120)

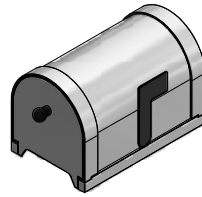

A6P00017 | MAILBOX
(x1)



H100542 | SCREW PFH SD
(x4) | 8x2



H100382 | SCREW PFH BLK
(x1) | 8x1 3/4

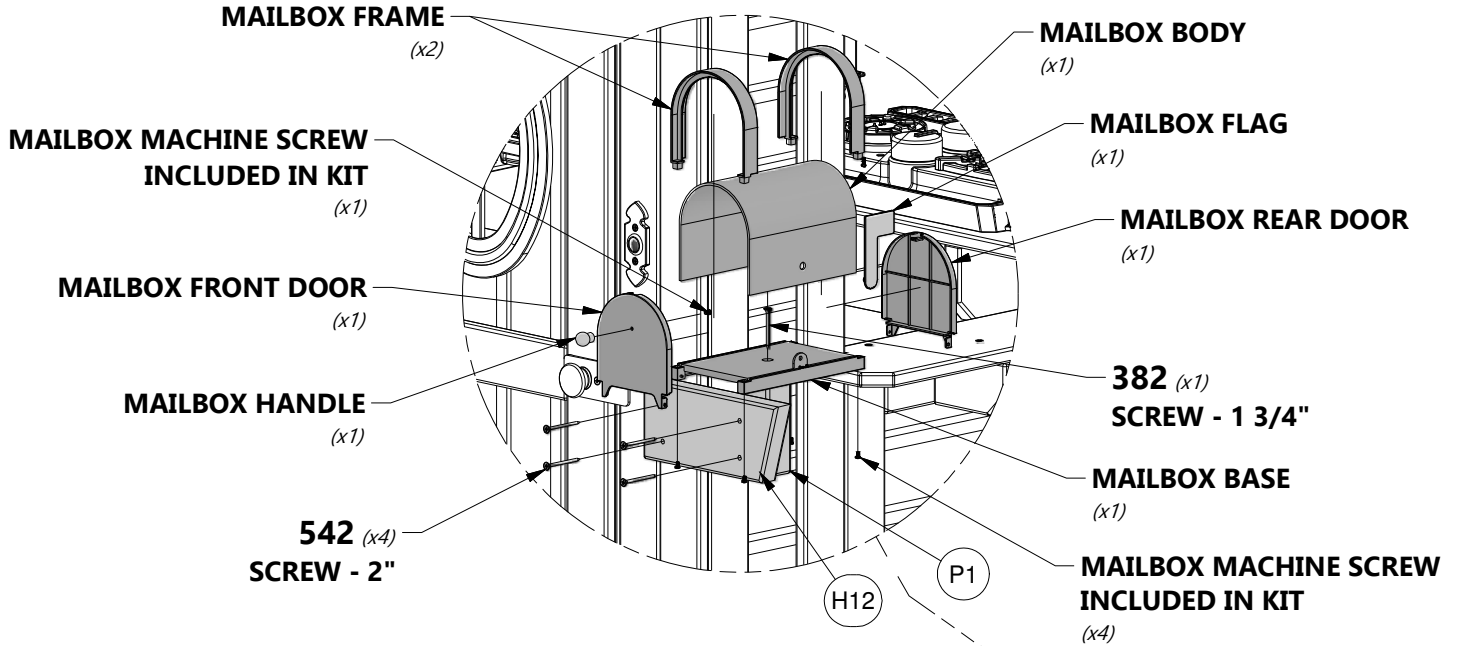

NOTE:
MOUNT H12 FIRST,
THEN P1,
THEN MOUNT MAILBOX BASE.
ALIGN PILOT HOLES.

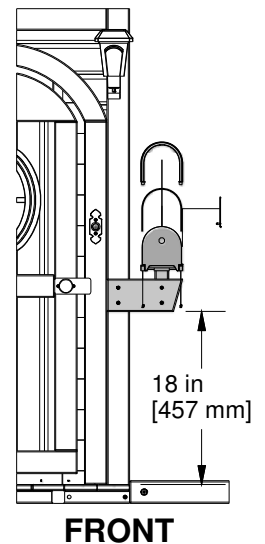
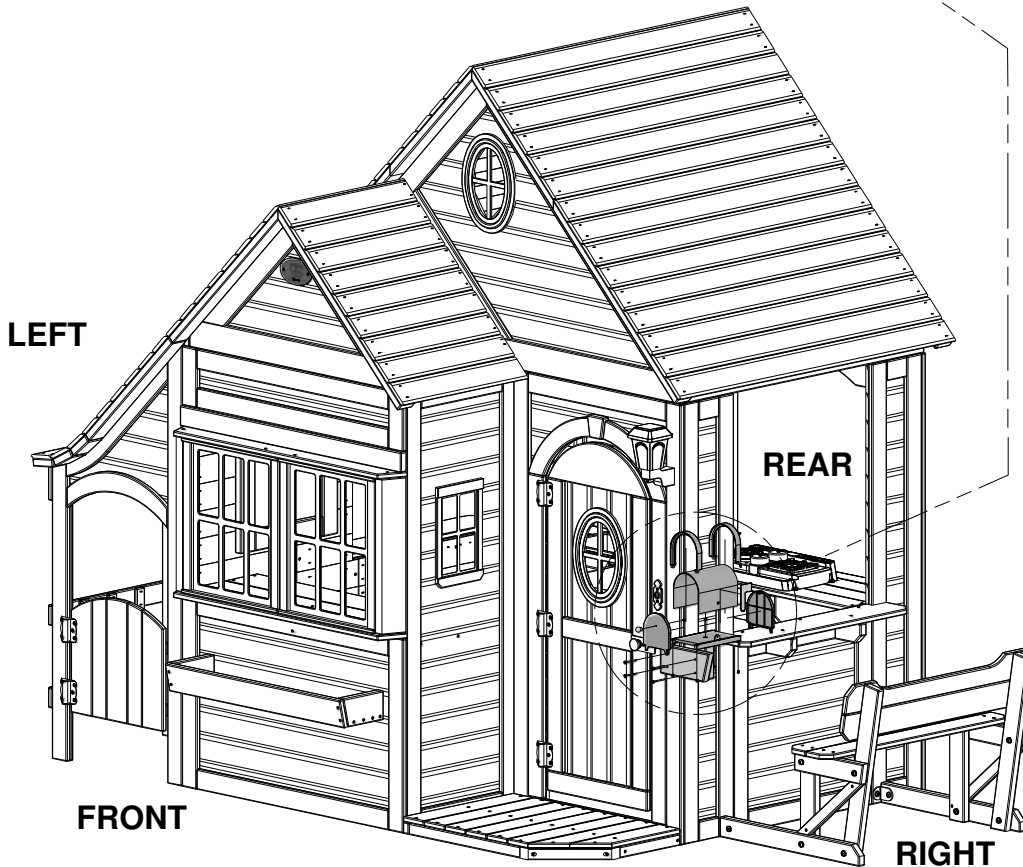



M3 | FASCIA BOARD - W4L08986
(x1) | 5/8"x3 3/8"x48 1/8" (16x86x1222)

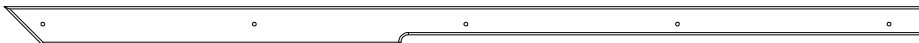

N4 | FASCIA BOARD - W4L11789
(x1) | 5/8"x2"x48 1/8" (16x50x1222)



H100538 | SCREW PFH SD
(x10) | 8x1 1/2

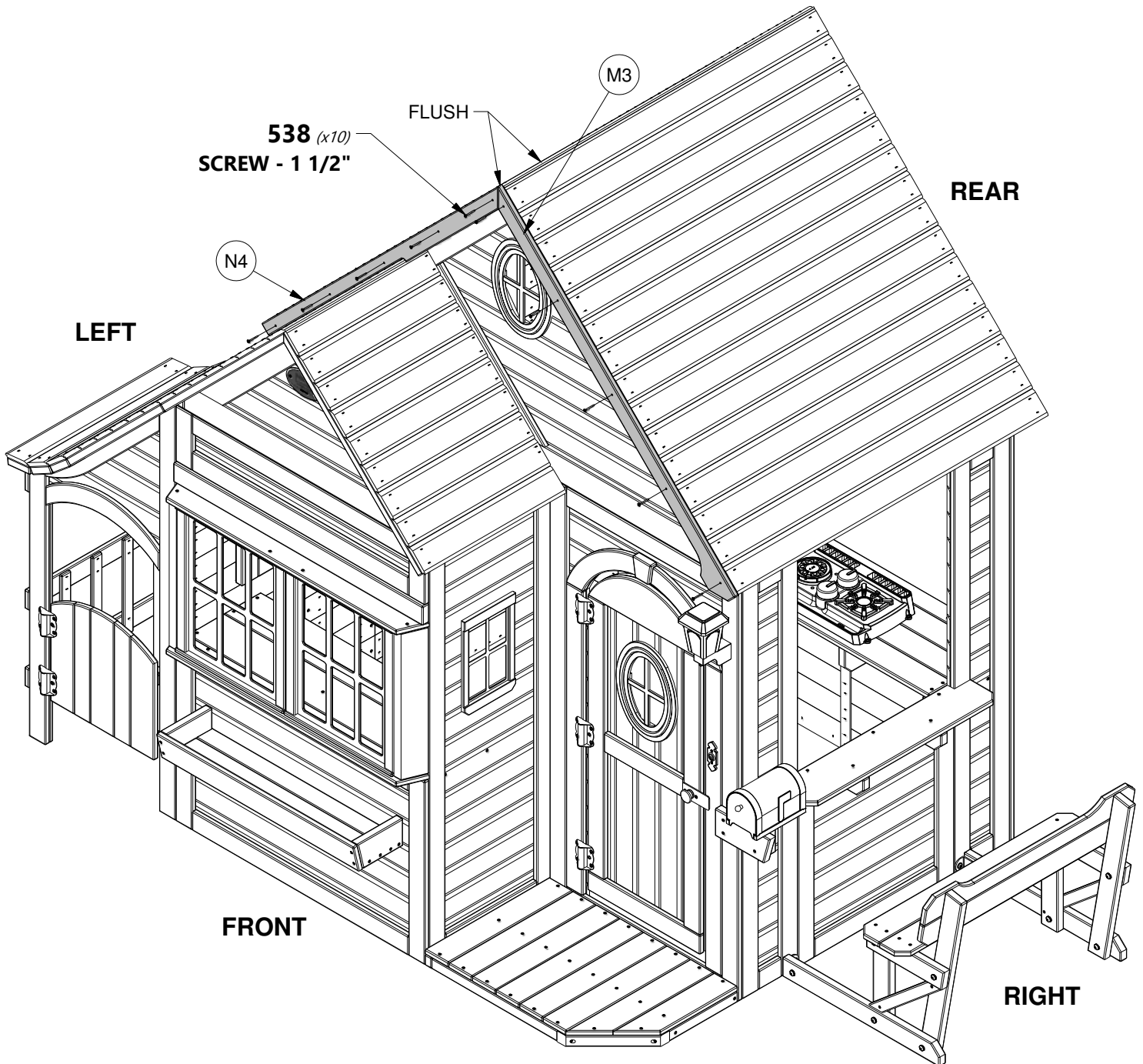

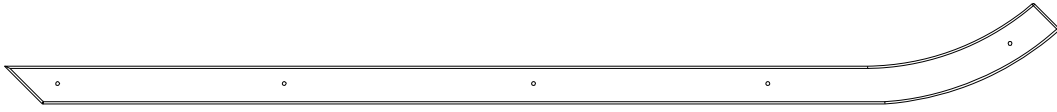

K5 | FASCIA BOARD - W4L11678
(x1) | 5/8"x5 1/4"x55" (16x133x1395)

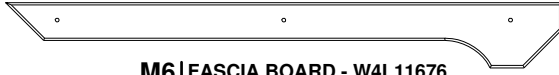

M6 | FASCIA BOARD - W4L11676
(x1) | 5/8"x3 3/8"x29" (16x86x736)



H100538 | SCREW PFH SD
(x8) | 8x1 1/2

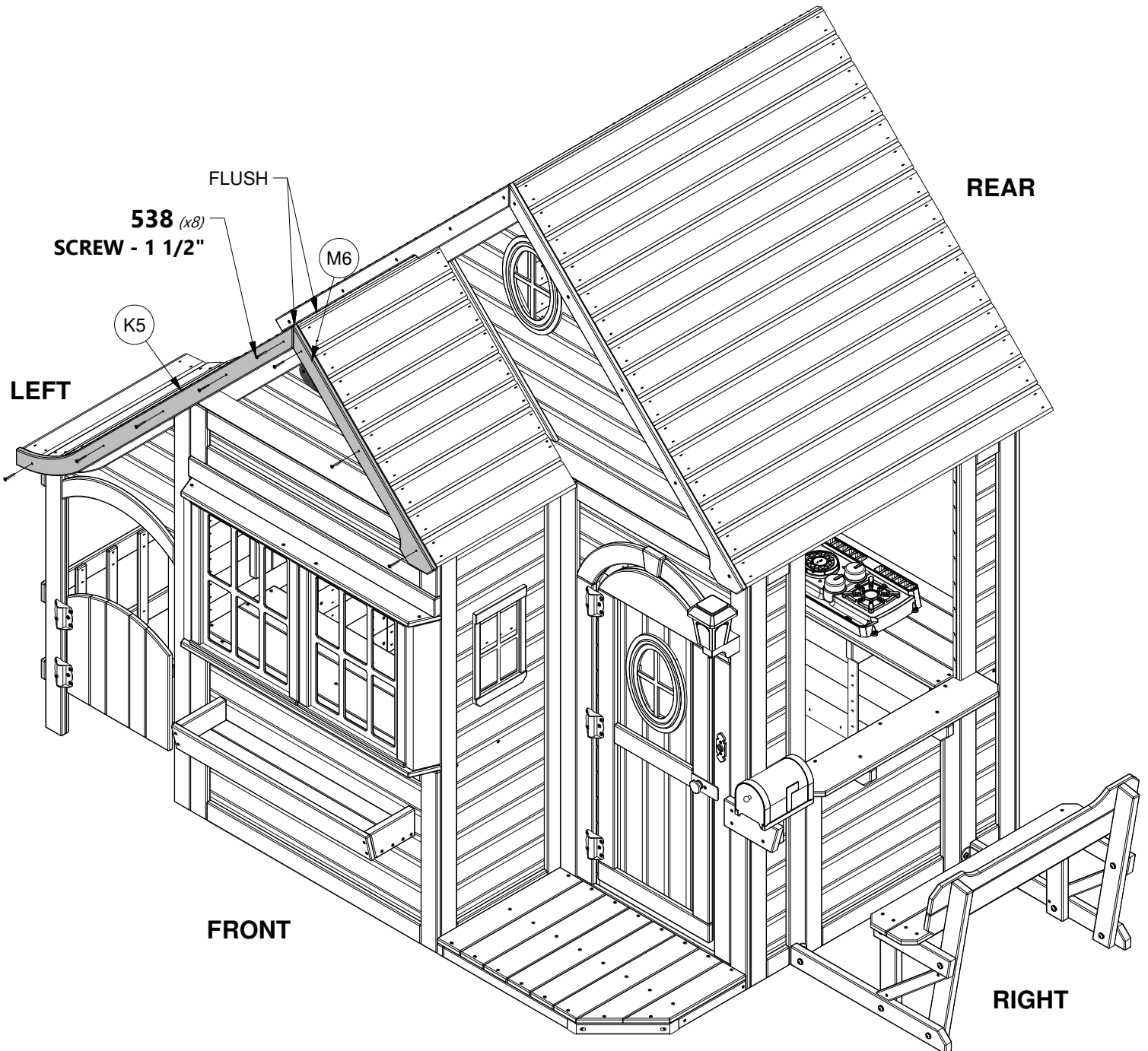

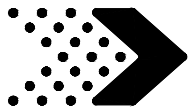

M3 | FASCIA BOARD - W4L08986
(x2) | 5/8"x3 3/8"x48 1/8" (16x86x1222)



H100538 | SCREW PFH SD
(x10) | 8x1 1/2"

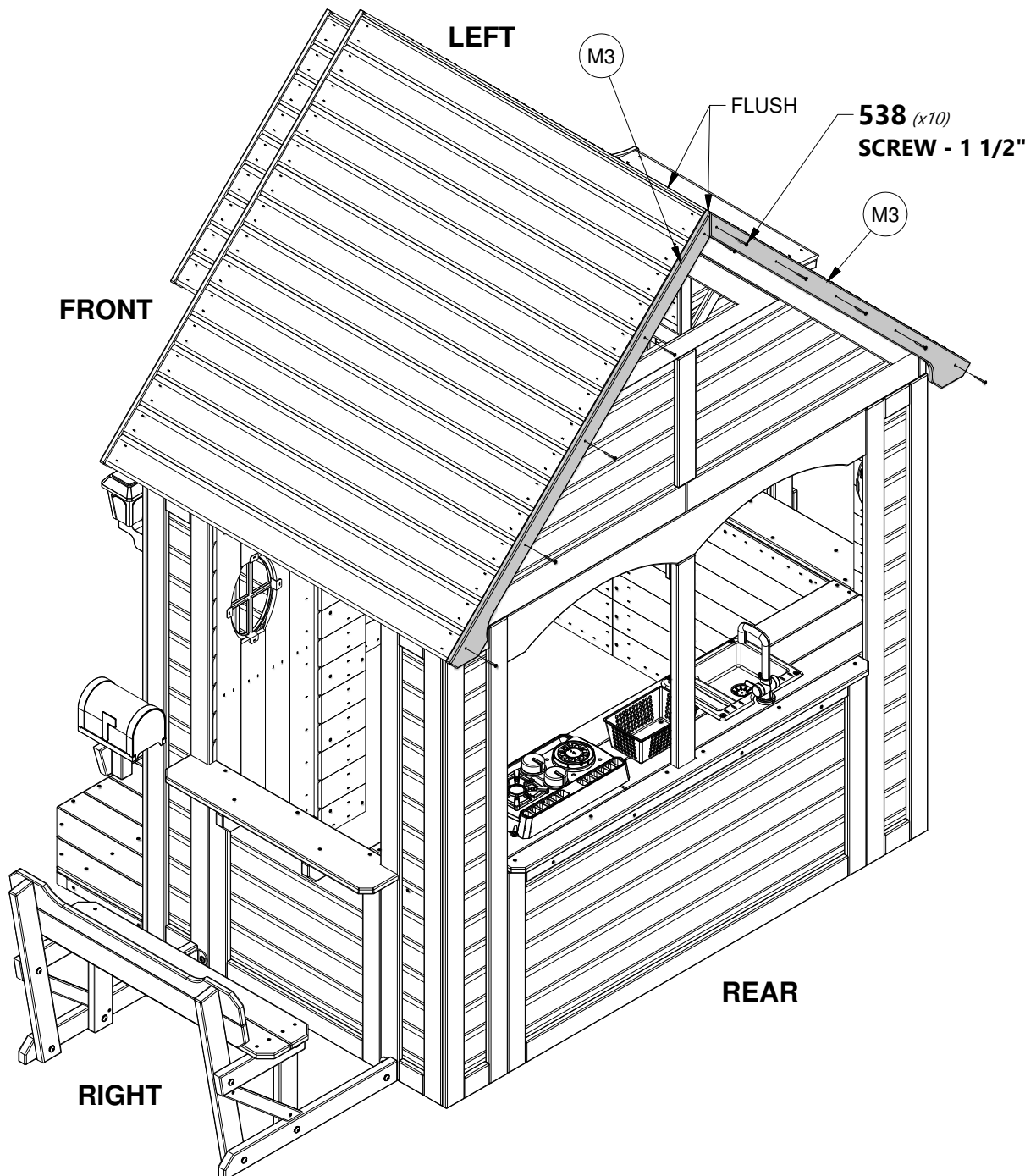

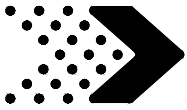

Phase 4

STEP 16

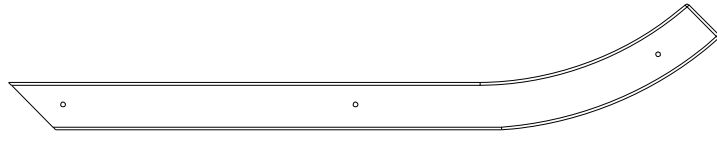

K4 | FASCIA BOARD - W4L11795
(x1) | 5/8"x5 1/4"x29 5/8" (16x133x752)



H100538 | SCREW PFH SD
(x3) | 8x1 1/2

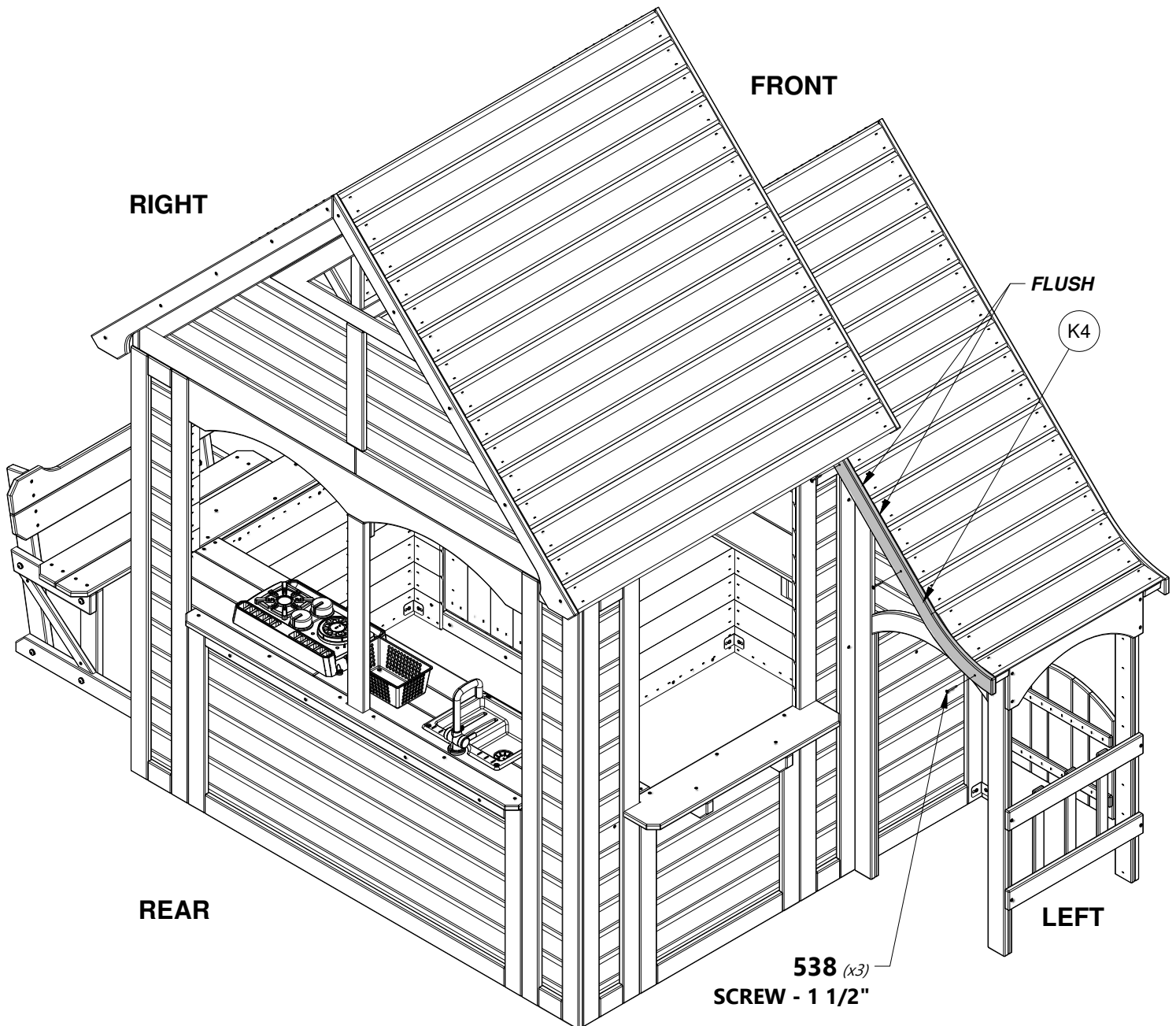

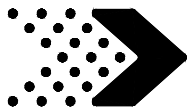

Phase 4

STEP 17



A4M00527
(x4) | **GROUND STAKE REBAR**



H100192
(x4) | **NUT BARREL WH BLK**
5/16x7/8



H100199
(x4) | **WASHER LOCK EXT BLK**
12x19



H100663
(x4) | **BOLT WH BLK**
5/16x3/4

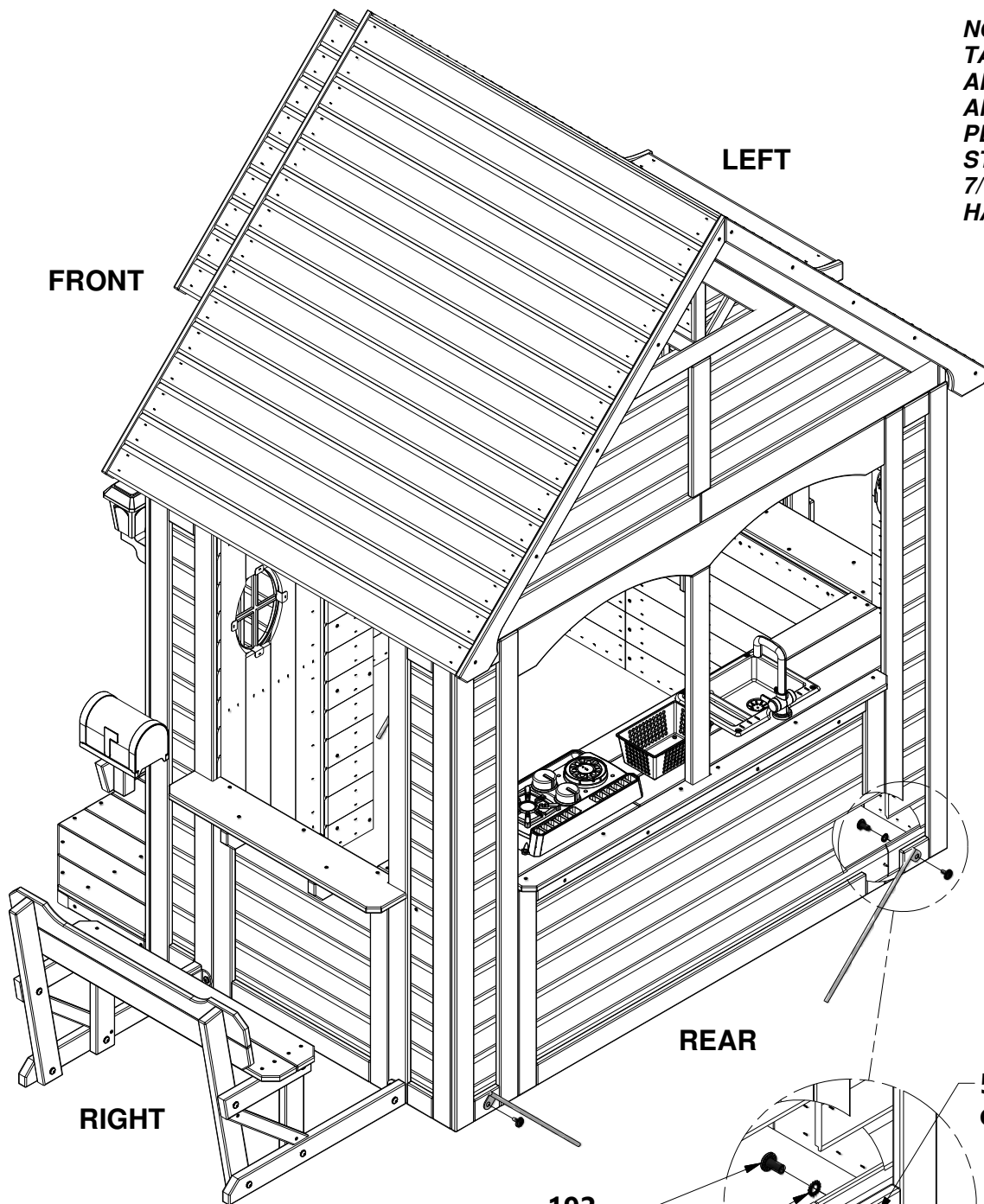

NOTE:
TAP IN GROUND STAKES AT AN APPROXIMATE 45° ANGLE AT 4 CORNERS OF PLAYHOUSE. USING GROUND STAKE AS A GUIDE, DRILL 7/16" DIA HOLES FOR HARDWARE.

192 (x4)
NUT BARREL - 7/8"

199 (x4)
WASHER - 12x19

527 (x4)
GROUND STAKE REBAR

663 (x4)
BOLT - 3/4"

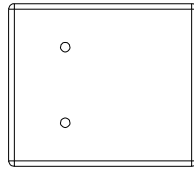
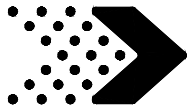

M7 | DOOR STOP - W4L11734
(x1) | 5/8"x3 3/8"x3 15/16" (16x86x100)



H100538 | SCREW PFH SD
(x2) | 8x1 1/2

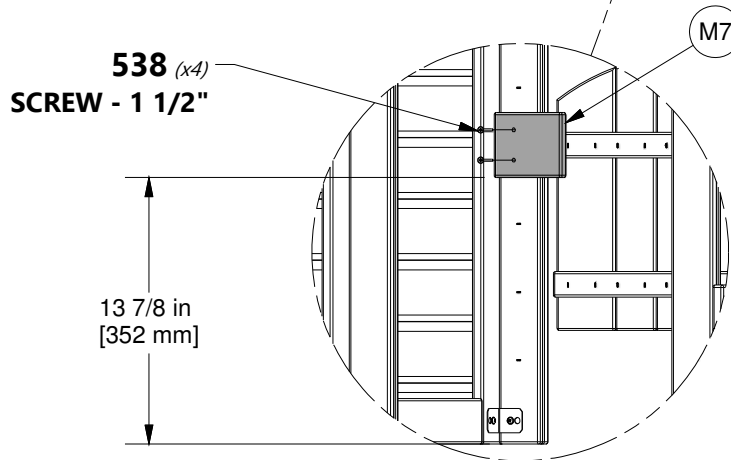
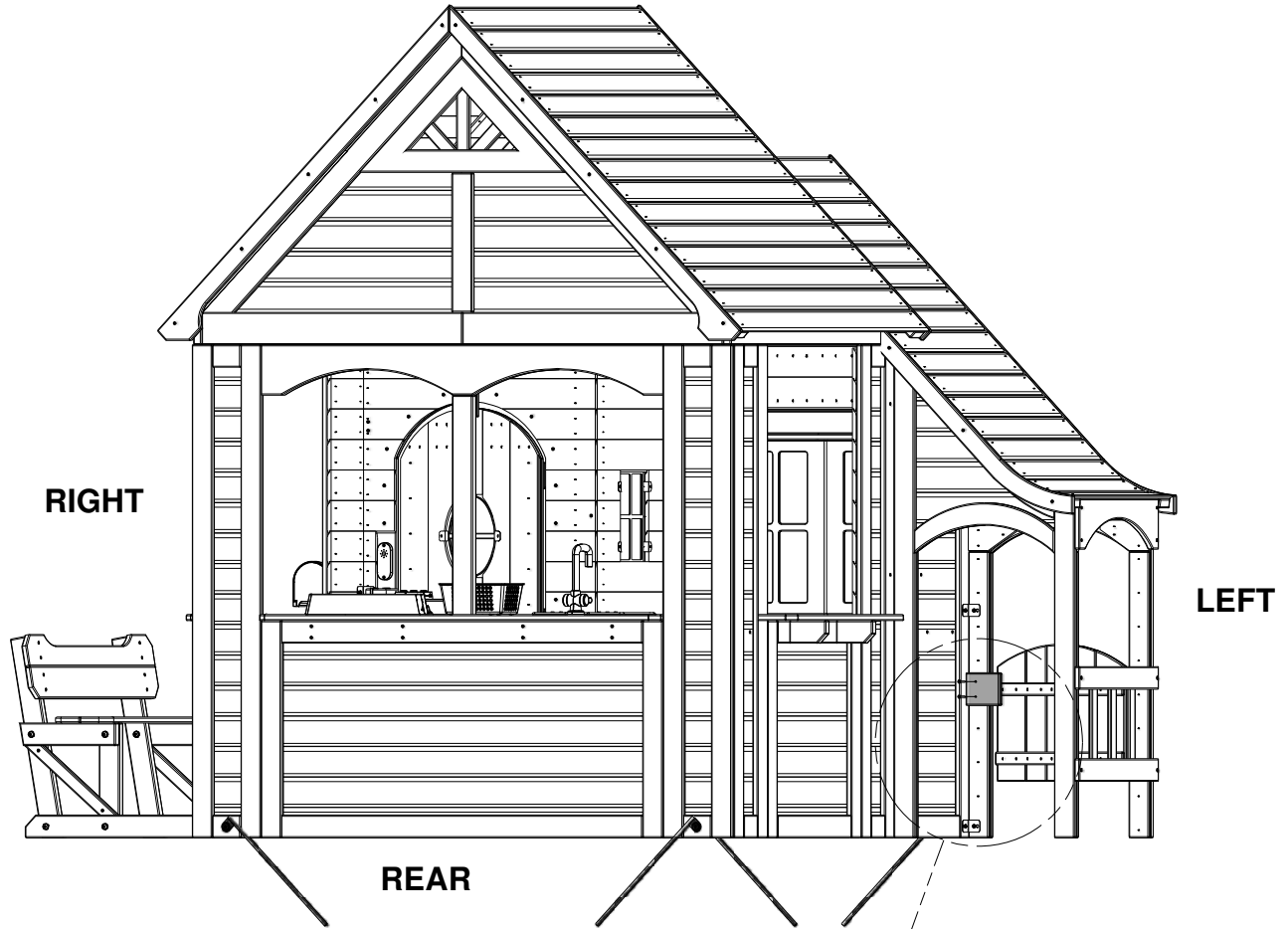

NOTE:
PLACE M7 TIGHT IN CORNER THEN INSTALL SCREWS.

Note:

This equipment has been tested and found to comply with the limits for a Class B digital device, pursuant to part 15 of the FCC Rules. These limits are designed to provide reasonable protection against harmful interference in a residential installation. This equipment generates, uses and can radiate radio frequency energy and, if not installed and used in accordance with the instructions, may cause harmful interference to radio communications. However, there is no guarantee that interference will not occur in a particular installation. If this equipment does cause harmful interference to radio or television reception, which can be determined by turning the equipment off and on, the user is encouraged to try to correct the interference by one or more of the following measures:

- Reorient or relocate the receiving antenna.
- Increase the separation between the equipment and receiver.
- Connect the equipment into an outlet on a circuit different from that to which the receiver is connected.
- Consult the dealer or an experienced radio/TV technician for help

Caution: Changes or modifications not expressly approved by the party responsible for