

# **CORTEX<sup>®</sup>**

## **SM26 Pulley Station Add On**

### **USER MANUAL**

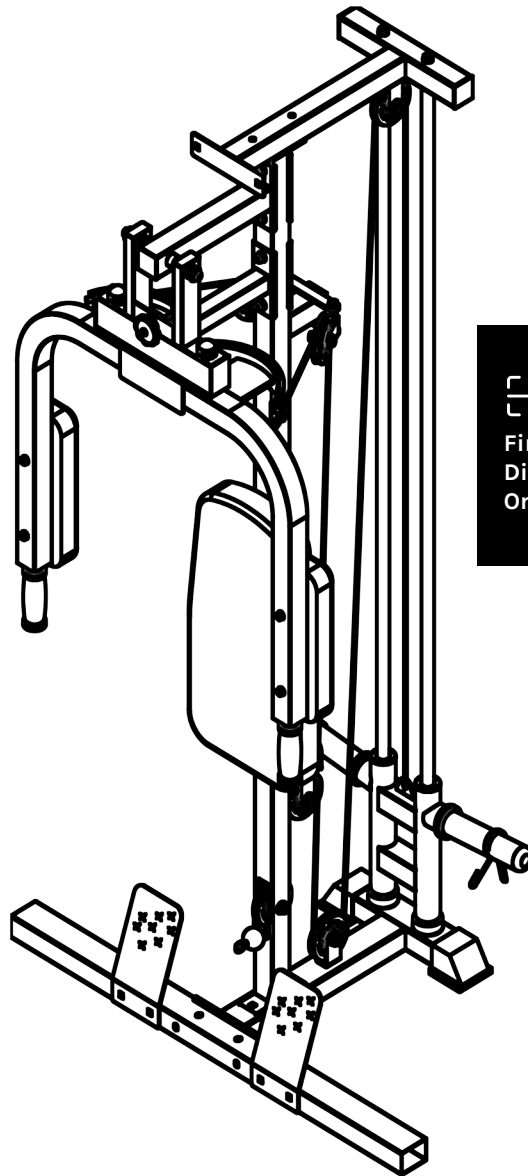

Find the  
Digital Manual  
Online



Product may vary slightly from the item pictured due to model upgrades.



**Read all instructions carefully before using this product.  
Retain this owner's manual for future reference.**

NOTE:

This manual may be subject to updates or changes. Up to date manuals are available through our website at [www.lifespanfitness.com.au](http://www.lifespanfitness.com.au)



# TABLE OF CONTENTS

I. Important Safety Instructions .....	03
II. Care Instructions .....	04
III. Parts List .....	05
IV. Assembly Instructions .....	07
V. Exercise Guide .....	11
VI. Maintenance .....	12
VII. Warranty .....	13

# I. IMPORTANT SAFETY INSTRUCTIONS

---

 **WARNING: Read all instructions before using this machine.**

---

To ensure your safety, read the following precautions before using this product

1. Please read, study and understand the instructions and all warning labels before use.  
(It is recommended to be familiar with the normal operation and use methods of the device before using this product. Information is available on this manual and at local retailers).
2. Please keep this manual and ensure that all the warning labels are clear and complete.
3. This product is recommended to install by more than two people.
4. Please consult your doctor's advice before starting the exercise.
5. Please ensure safety when the children are present.
6. Be careful when using it with children present.
7. Please check any signs of wear of the wire rope regularly. If there is wear, it may cause some danger to you.
8. Please keep your hands, limbs and clothes stretch to use the device.
9. Please note any signs of machinery that may occur, including part wear, loose hardware, and welding cracks. Stop using the device with the above signs immediately and contact the after-sales service department of our company.
10. You can complete the assembly with a wrench, or an inner hexagon wrench.
11. The user weight of this product shall not exceed 100kg.
12. The product is subject to change without notice and the final interpretation belongs to the Division.









































## II. CARE INSTRUCTIONS

- Lubricate moving joints with silicon spray after periods of usage.
- Be careful not to damage plastic or metal parts of the machine with heavy or sharp objects.
- The machine can be kept clean by wiping it down using dry cloth.
- Check and adjust the tension of wire rope on a regular basis.
- Regularly check all moving parts and make sure there are signs of wear and damage, if any the use of the device must be stopped immediately and contact our after-sales department.
- During inspection, it is necessary to make sure that all bolts and nuts are completely fixed. If any bolt or nut connection is loosened, please re-tighten.
- Check weld for cracks.
- Failure to perform daily maintenance may result in personal injury or equipment damage.

# III. PARTS LIST

Key No.	Description	Qty.
1	Left Butterfly Arm	1
2	Right Butterfly Arm	1
3	Back Rest Upright Column	1
4	Cable Rail Bottom Feet	1
5	Cable Rail Top Frame	1
6	Weight Holder	1
7	Foot Plate	2
8	Back Rest	1
9	Arm Pads	2
10	Sleeve	2
11	Cable Rods	2
12	Butterfly Arm Frame	1
13	Joint Frame Bottom	1
14	Joint Frame Top	1
15	Pulley	6
16	Cable 4370mm	1
17	Cable 2895mm	1
18	Pulley Diaphragms	2
19	Nut Cap	2
20	Collars	2
21	Large Shock Pad	2

Key No.	Description	Qty.
22	Knob	1
23	Frame Shaft	1
24	Connecting Plate	2
25	Flat Connecting Sheets	2
26	Pulley Block	2
27	Cross Pulley Block	1
28	Screw Sleeve Welding	1
29	Connecting Plate	1
30	Bolt M10x90mm	6
31	Bolt M10x70mm	13
32	Bolt M10x60mm	1
33	Bolt M10x45mm	6
34	Bolt M10x20mm	4
35	Bolt M8x65mm	6
36	Bolt M6x35mm	2
37	Large Washer Ø10	2
38	Flat Washer Ø10	54
39	Washer Ø8	6
40	Nut M10	28
41	Nut M5	2

- |    |  |    |   |    |  |    |   |    |   |    |   |
|----|--|----|---|----|--|----|---|----|---|----|---|
| 1  |                       | 2  |                                  | 3  |                           | 4  |                        | 5  |                      |    |   |
| 6  |                       | 7  |                                  | 8  |                           | 9  |                        | 10 |                      |    |   |
| 11 |                       | 12 |                                  | 13 |                           | 14 |                        | 15 |                      |    |   |
| 16 | <br>length: 4370mm   | 17 | <br>length: 2895mm              | 18 |                          | 19 |                       | 20 |                     |    |   |
| 21 |                     | 22 |                                | 23 |                         | 24 |                      | 25 |                    |    |   |
| 26 |                     | 27 |                                | 28 |                         | 29 |                      | 30 | <br>M10 x 90 6pcs. |    |   |
| 31 | <br>M10 x 70 13pcs. | 32 | <br>M10 x 60 1pc.              | 33 | <br>M10 x 45 6pcs.      | 34 | <br>M10 x 20 4pcs.   | 35 | <br>M8 x 65 6pcs.  |    |   |
| 36 | <br>M6 x 35 2pcs.   | 37 | <br>enlarge $\varphi$ 10 2pcs. | 38 | <br>$\varphi$ 10 54pcs. | 39 | <br>$\varphi$ 8 6pcs. | 40 | <br>M10 28pcs.     | 41 | <br>M6 2pcs. |

# IV. ASSEMBLY INSTRUCTIONS

## ⚠ IMPORTANT:

1. The washer should be placed at both ends of the bolt (anti-bolt head and nut), unless otherwise specified.
2. During the preliminary assembly tighten all bolts and nuts by hand, and then tighten with wrench for complete assembly.
3. Some parts from the list are pre-assembled on the equipment.
4. This product is recommended to be installed with 2 or more people.

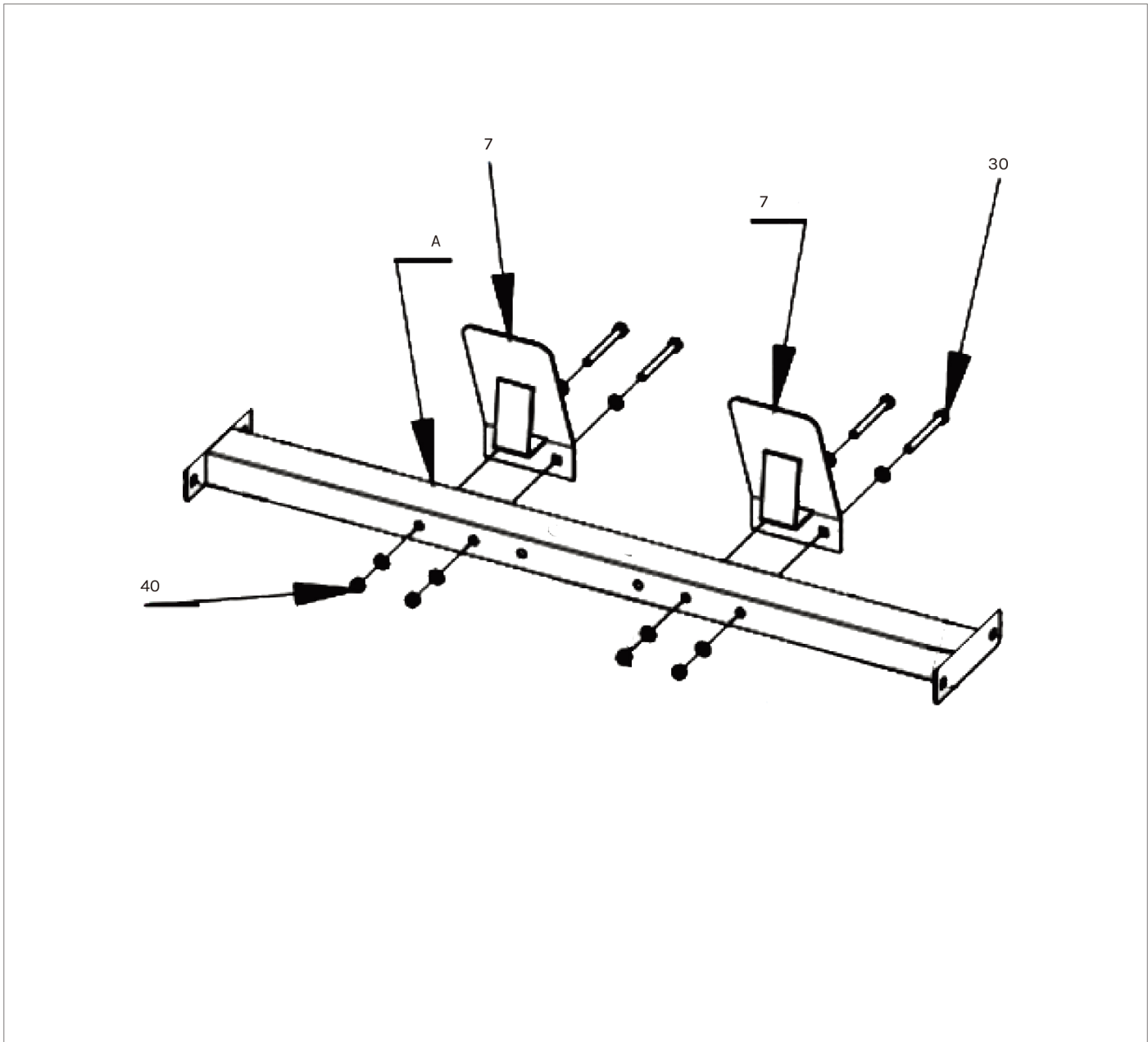

## STEP 1

1. Place (#7) onto part (#A) side as shown in the drawing, and use the bolts (#30), flat spacers (#38), nut (#40) to secure.

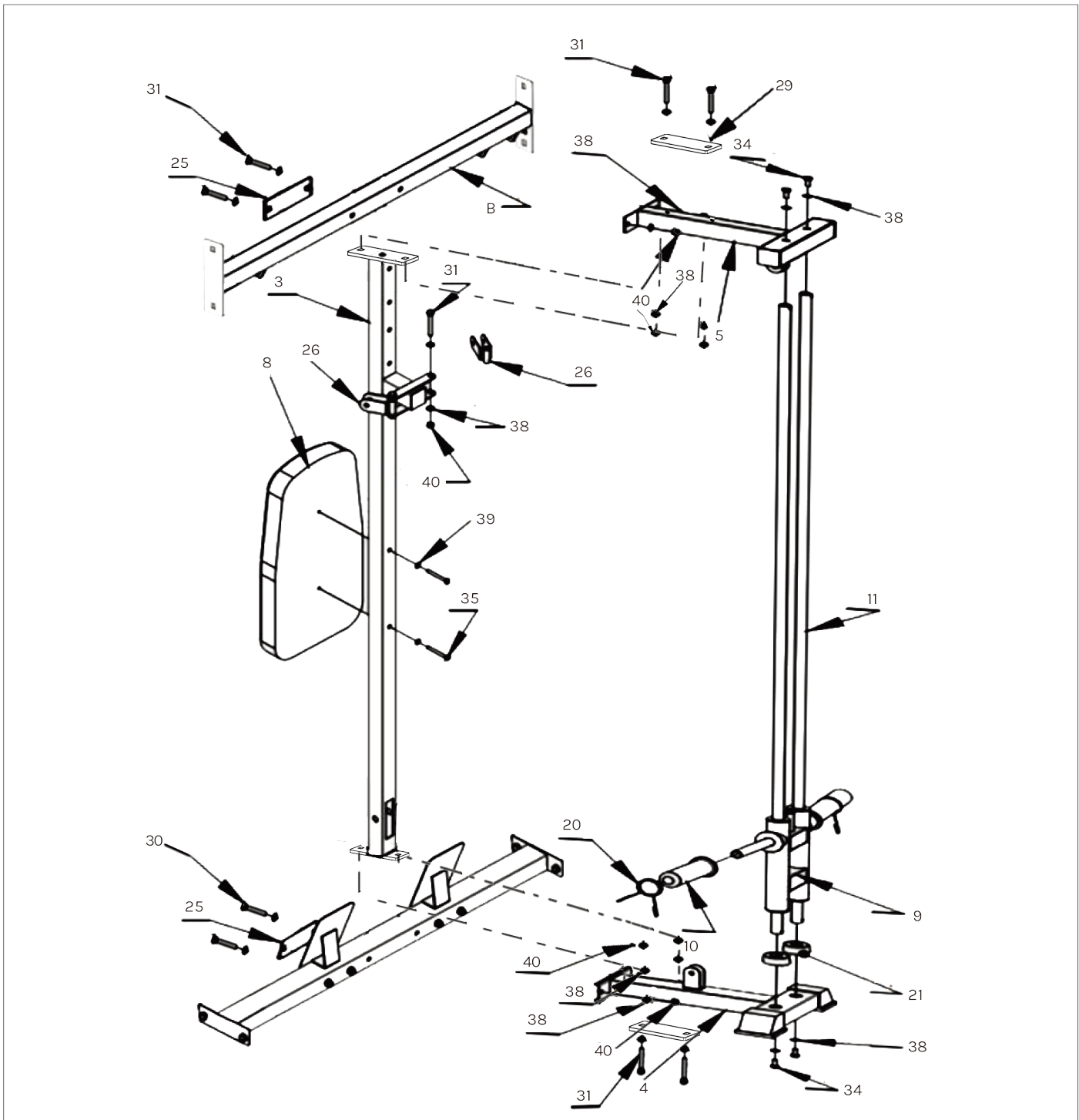

## STEP 2

1. Preinstall (29#) under (#4) according to the figure, place (#25) on the side of (#A), connect (#4) with (#A), and fix with bolts (#30) gaskets (#38) nuts (#40).
2. Insert (#11) into (#4) according to the figure, then insert (#21) and (#9) into (#11), and then insert (#10) into (#9).
3. insert (#5) hole into (#11), and then connect (#5) with (# B), fixed with connecting plate (#25), bolt (#31) (#34), gasket (# 38) nut (#40).
4. Pre-install (#8) and (26#) to (#3) according to the figure, and connect the pre-installed (#3) to (#4) and (#5). Secure with connecting plate (#29) bolt (#31) gasket (#38) nut (#40).



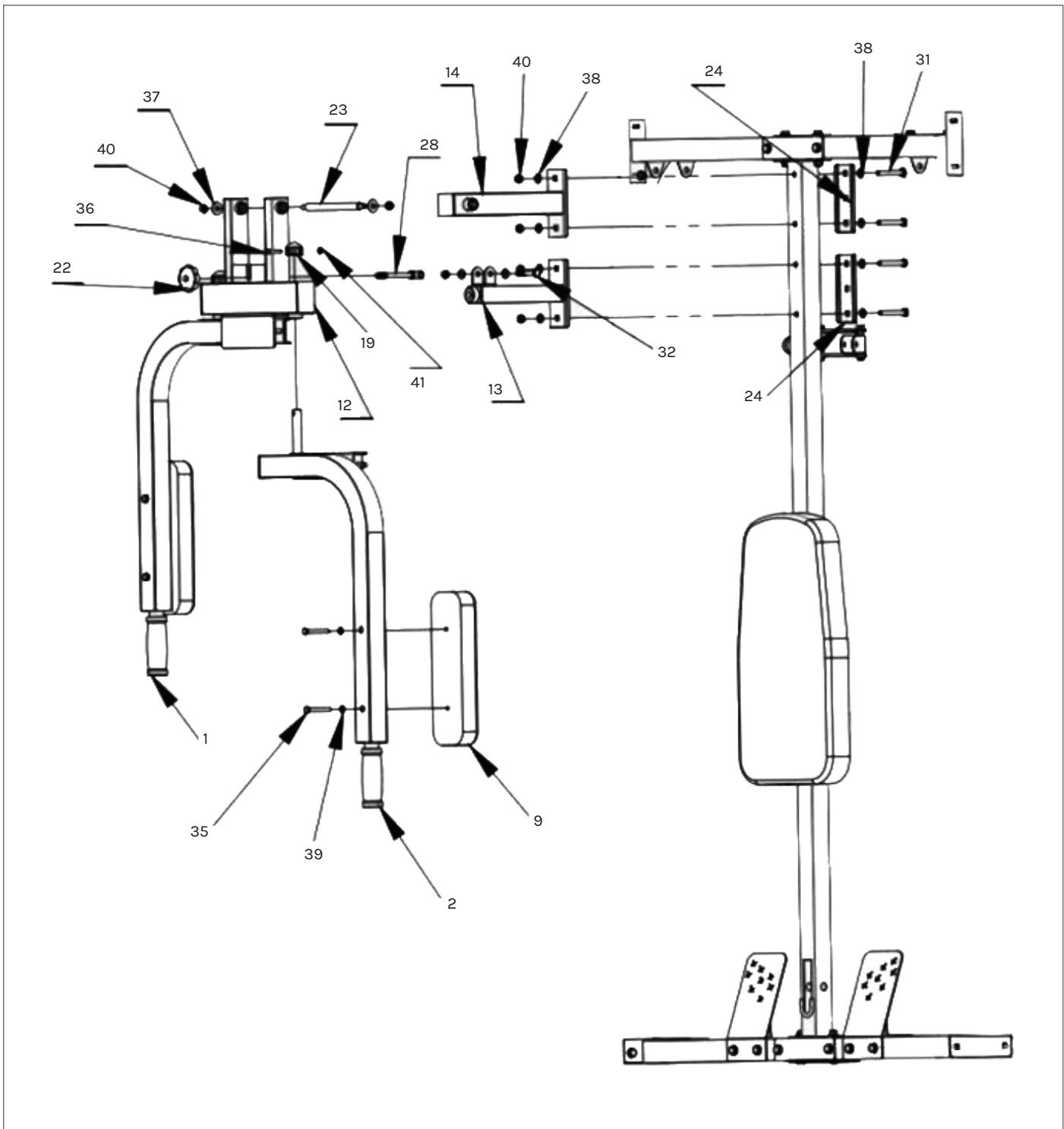

### STEP 3

1. According to the diagram, place (#13) and (#14) to the front of (#3), and (#24) at the back, then tighten with bolts (#31), flat spacer (#38) and nuts (#40).
2. According to the diagram, place (#12) on both sides of (#14) and pass through (#23) and tighten it with the flat gasket (#37) and nut (#40).
3. Place (#28) inside (#13) as per the diagram, then insert in (#32) and tighten with flat gasket (#38) and nut (#40). Screw on (#22).
4. Set (#2) onto (#12) according to the diagram, cover (#19) with bolts (#36) and nuts (#41). Attach (#9) onto (#2) with flat pads (#39) and bolts (#35).
5. Repeat on the other side.

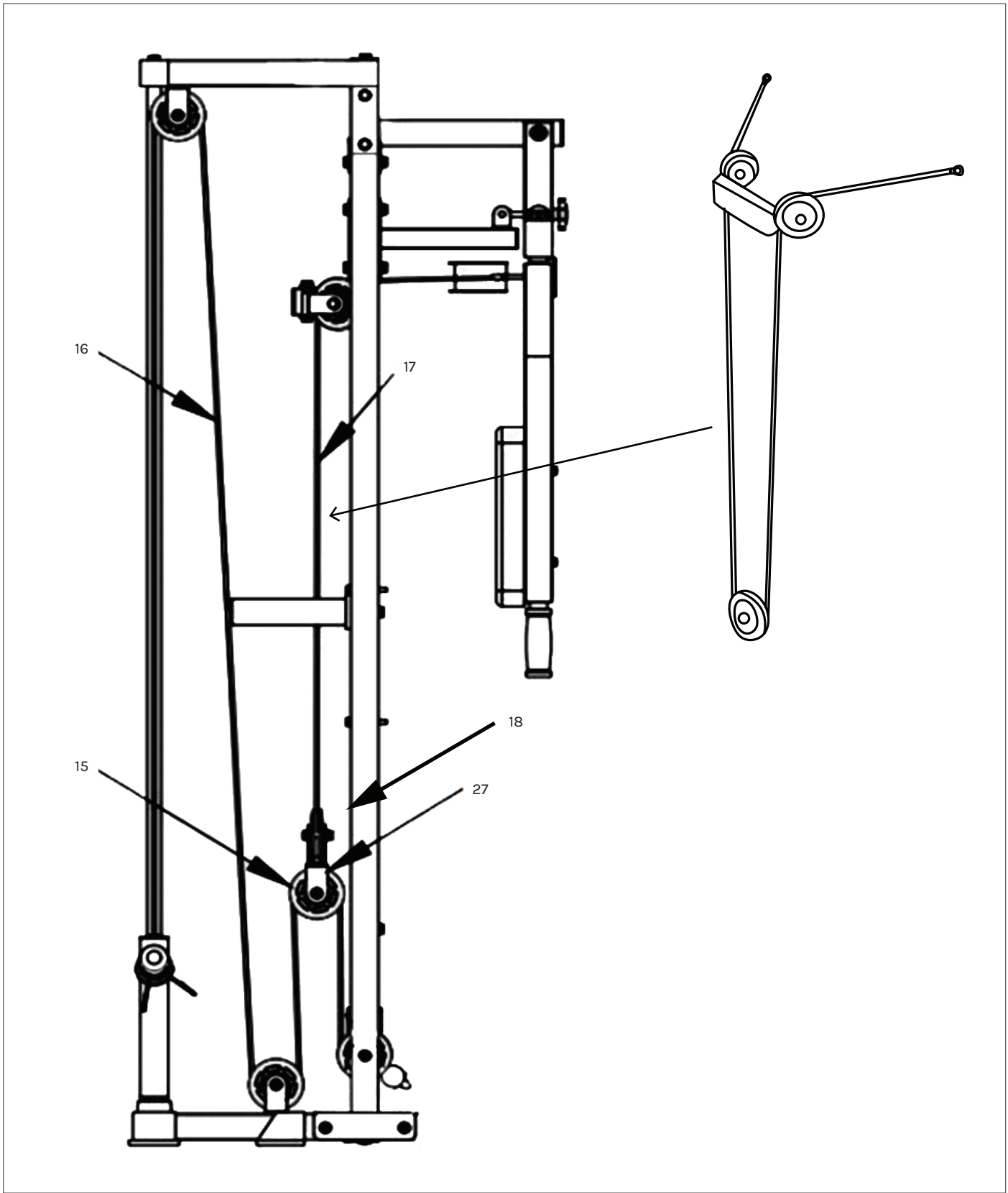

#### STEP 4

**NOTE:** Be sure to install the wire rope before installing the pulley.

Run the cable into the pulleys as shown and secure the pulleys with bolt 31 on part 3 and all others using bolt 33.

# V. EXERCISE GUIDE

## ! PLEASE NOTE:

Before beginning any exercise program, consult your physician. This is important especially if you are over the age of 45 or individuals with pre-existing health problems.

The pulse sensors are not medical devices. Various factors, including the user's movement, may affect the accuracy of heart rate readings. The pulse sensors are intended only as an exercise aid in determining heart rate trends in general.

Exercising is a great way to control your weight, improve your fitness and reduce the effect of aging and stress. The key to success is to make exercise a regular and enjoyable part of your everyday life.

The condition of your heart and lungs and how efficient they are in delivering oxygen via your blood to your muscles is an important factor to your fitness. Your muscles use this oxygen to provide enough energy for daily activity. This is called aerobic activity. When you are fit, your heart will not have to work so hard. It will pump a lot fewer times per minute, reducing the wear and tear of your heart.

So as you can see, the fitter you are, the healthier and greater you will feel.

## WARM UP

Start each workout with 5 to 10 minutes of stretching and some light exercises. A proper warm-up increases your body temperature, heart rate and circulation in preparation for exercise. Ease into your exercise.

After warming up, increase the intensity to your desired exercise program. Be sure to maintain your intensity for maximum performance. Breathe regularly and deeply as you exercise.

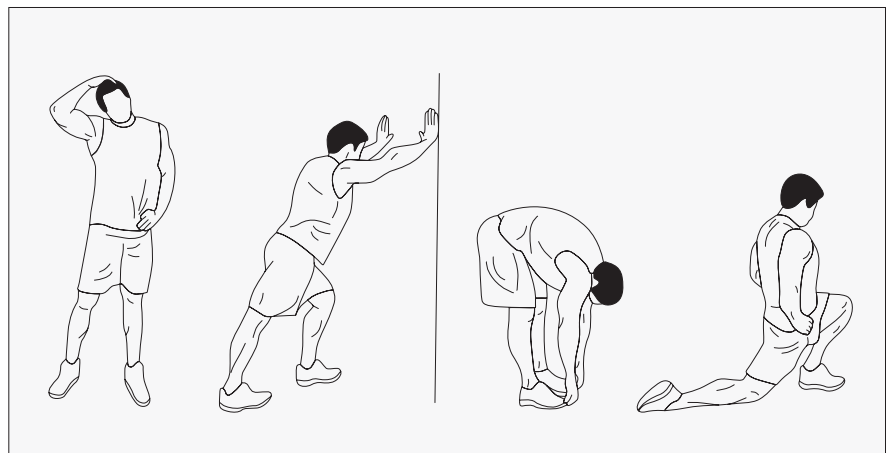

## COOL DOWN

Finish each workout with a light jog or walk for at least 1 minute. Then complete 5 to 10 minutes of stretching to cool down. This will increase the flexibility of your muscles and will help prevent post-exercise problems.

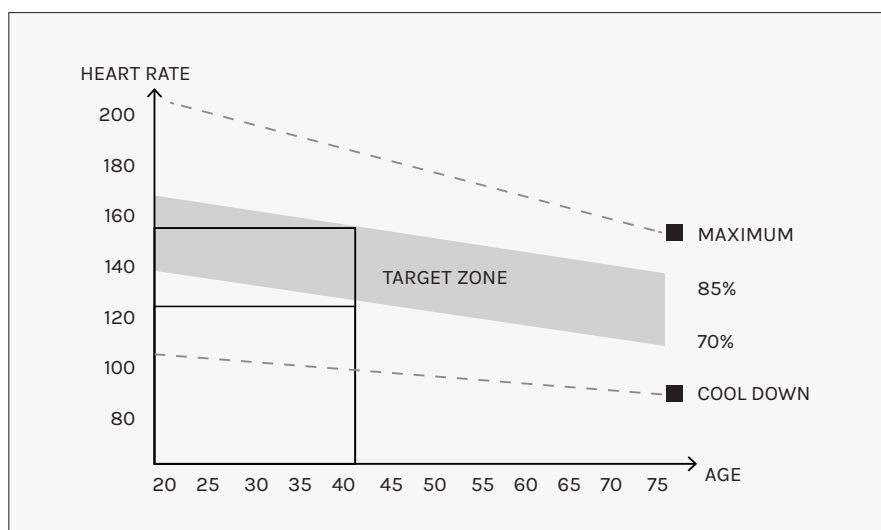

## WORKOUT GUIDELINES

! This is how your pulse should behave during general fitness exercise. Remember to warm up and cool down for a few minutes.

# VI. MAINTENANCE

## MAINTENANCE METHOD:

To extend the service life of the device, the parts must be lubricated on time. The product has been initially lubricated before leaving the factory, but lubrication is required between the guide rod and the weight plate over time.

 **NOTE:** Silicon oil/spray is recommended for lubrication.

1. Pulley and wire ropes should be regularly checked for signs of wear.
2. Check and adjust the tension of the wire rope regularly.
3. Check all moving parts regularly. If there is a damaged part, stop using the device immediately and contact the store.
4. Ensure all bolts and nuts are fully fixed and re-tighten them when it is loose.
5. Check the welding for cracks.
6. Failure to perform routine maintenance may cause personal injury or equipment damage.
7. Ensure any handle attachments are fully secured before use to prevent from injury.

# VII. WARRANTY

## AUSTRALIAN CONSUMER LAW

Many of our products come with a guarantee or warranty from the manufacturer. In addition, they come with guarantees that cannot be excluded under the Australian Consumer Law. You are entitled to a replacement or refund for a major failure and compensation for any other reasonably foreseeable loss or damage.

You are entitled to have the goods repaired or replaced if the goods fail to be of acceptable quality and the failure does not amount to a major failure. Full details of your consumer rights may be found at [www.consumerlaw.gov.au](http://www.consumerlaw.gov.au).

Please visit our website to view our full warranty terms and conditions:  
<http://www.lifespanfitness.com.au/warranty-repairs>

## WARRANTY AND SUPPORT

Any claim against this warranty must be made through your original place of purchase. Proof of purchase is required before a warranty claim may be processed.

If you have purchased this product from the Official Lifespan Fitness website, please visit <https://lifespanfitness.com.au/warranty-form>

For support outside of warranty, if you wish to purchase replacement parts or request a repair or service, please visit <https://lifespanfitness.com.au/warranty-form> and fill in our Repair/Service Request Form or Parts Purchase Form.

Scan this QR code with your device to go to [lifespanfitness.com.au/warranty-form](https://lifespanfitness.com.au/warranty-form)







***CORTEX***<sup>®</sup>

[WWW.LIFESPANFITNESS.COM.AU](http://WWW.LIFESPANFITNESS.COM.AU)