

*Life*SPAN

TURBO PRO



USER'S MANUAL

Product may vary slightly from the item pictured due to model upgrades

CONTENTS

1	IMPORTANT SAFETY INSTRUCTIONS	2
	1.1	IMPORTANT ELECTRICAL INFORMATION 3
	1.2	IMPORTANT OPERATIONAL INSTRUCTIONS 4
	1.3	KEY COMPONENTS OF THE TREADMILL 5
2	ASSEMBLY INSTRUCTIONS	6
	2.1	FOLDING INSTRUCTIONS 8
3	DISPLAY PANEL OPERATIONS	9
	3.1	SAFETY KEY 9
	3.2	GETTING STARTED 9
	3.3	QUICK START OPERATING 10
	3.4	INCLINE FEATURE 10
	3.5	PULSE GRIP FEATURE 10
	3.6	CALORIE DISPLAY 10
	3.7	TO SELECT A PROGRAM 10
	3.8	USER PROGRAM 11
	3.9	ENTERTAINMENT
	3.10	PRESET PROGRAM 11
4	MAINTENANCE	16
	4.1	GENERAL CLEANING 16
	4.2	GENERAL CARE 16
	4.3	BELT/DECK/ROLLER LUBRICATION 17
	4.4	HOW TO CHECK THE RUNNING MAT FOR PROPER LUBRICATION 17
	4.5	BELT ADJUSTMENT 18
	4.6	BELT TRACKING ADJUSTMENT 18
5	TROUBLESHOOTING	19
	5.1	ALARM SIGNALS 19
6	EXERCISE GUIDE	21
	6.1	WORKOUT GUIDELINES 22
7	WARRANTY REGISTRATION	23

1. IMPORTANT SAFETY INSTRUCTIONS

WARNING - Read all instructions before using this treadmill.

It is important your treadmill receives regular maintenance to prolong its useful life. Failing to regularly maintain your treadmill may void your warranty.

Danger—To reduce the risk of electric shock disconnect your treadmill from the electrical outlet prior to cleaning and/or service work.

DO NOT USE AN EXTENSION CORD: DO NOT ATTEMPT TO DISABLE THE GROUNDED PLUG BY USING IMPORPER ADAPTERS OR IN ANY WAY MODIFY THE CORD SET.

- Install the treadmill on a flat level surface with access to a 220-240 volt (50/60Hz), grounded outlet.
- Do not operate treadmill on deeply padded, plush or shag carpet. Damage to both carpet and treadmill may result.
- Do not block the rear of the treadmill. Provide a minimum of 1 metre clearance between the rear of the treadmill and any fixed object.
- Place your unit on a solid, level surface when in use.
- Never allow children on or near the treadmill.
- When running, make sure the plastic clip is fastened on your clothing. It is for your safety, should you fall or move too far back on the treadmill.
- Keep hands away from all moving parts.
- Never operate the treadmill if it has a damaged cord or plug.
- Keep the cord away from heated surfaces.
- Do not operate where aerosol spray products are being used or where oxygen is being administered. Sparks from the motor may ignite a highly flammable environment.
- Never drop or insert any object into any openings.
- The treadmill is intended for in-home use only and not suitable for long time running.
- To disconnect, turn all controls to the off position, remove the safety key, and then remove the plug from the outlet.

- The pulse sensors are not medical devices. Various factors, including the user's movement, may affect the accuracy of heart rate readings. The pulse sensors are intended only as exercise aids in determining heart rate trends in general.
- Use handrails provided; they are for your safety.
- Wear proper shoes. High heels, dress shoes, sandals or bare feet are not suitable for use on your treadmill. Quality athletic shoes are recommended to avoid leg fatigue.
- Allowed temperature: 5 to 40 degrees.

Remove the safety key after use to prevent unauthorized treadmill operation.

1.1 IMPORTANT ELECTRICAL INFORMATION

WARNING!

- NEVER use a ground fault circuit interrupt (GFCI) wall outlet with this treadmill. Route the power cord away from any moving part of the treadmill including the elevation mechanism and transport wheels.
- NEVER remove any cover without first disconnecting AC power.
- NEVER expose this treadmill to rain or moisture. This treadmill is not designed for use outdoors, near a pool, or in any other high humidity environment.

Technical Standard:

- Input voltage: 240v \pm 10% (50Hz or 60Hz).
- Environment temperature for working: 0 \sim + 40°C.
- Continuous Output Motor Power: 3.5HP.
- Electric current is less than 11A.
- Speed: 1.0-22.0 kilometers/hour (\pm 5%)
- Time limits: 00:00-99:59 (minute: second)
- Distance: 000-9.99 kilometers.
- Slope: 0-20°%
- Valid area for running belt: 140×53cm.

System Diagram

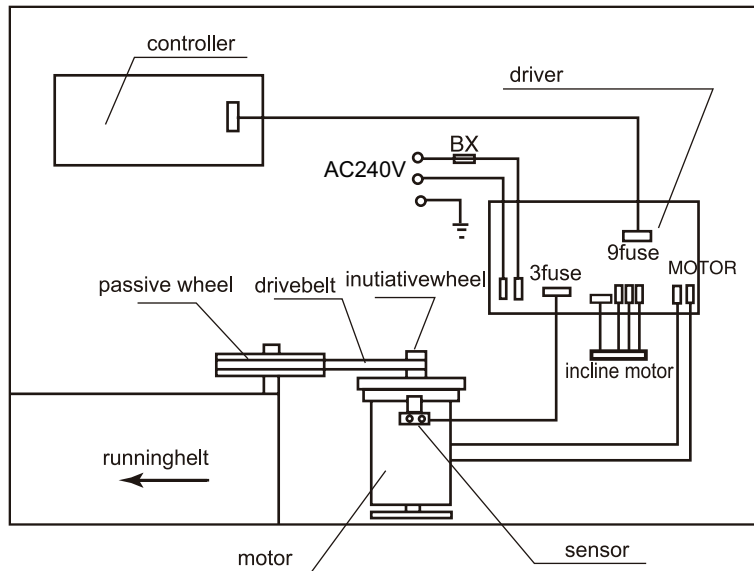

1.2 IMPORTANT OPERATION INSTRUCTIONS

- Be sure to read the entire manual before operating your machine.
- Understand that changes in speed and incline do not occur immediately. Set your desired speed on the computer console and release the adjustment key. The computer will obey the command gradually.
- Use caution while participating in other activities while walking on your treadmill; such as watching television, reading, etc. These distractions may cause you to lose balance or stray from walking in the centre of the belt; which may result in serious injury.
- In order to prevent losing balance and suffering unexpected injury, **NEVER** mount or dismount the treadmill while the belt is moving. This unit starts with a very low speed. Simply standing on the belt during slow acceleration is proper after you have learned to operate this machine.
- Always hold on to handrail while making control changes.
- A safety key is provided with this machine. Remove the safety key will stop the walking belt immediately; the treadmill will shut off automatically. Insert the safety key will reset the display.
- Do not use excessive pressure on console control keys. They are precision set to function properly with little finger pressure.

1.3 KEY COMPONENTS OF TREADMILL

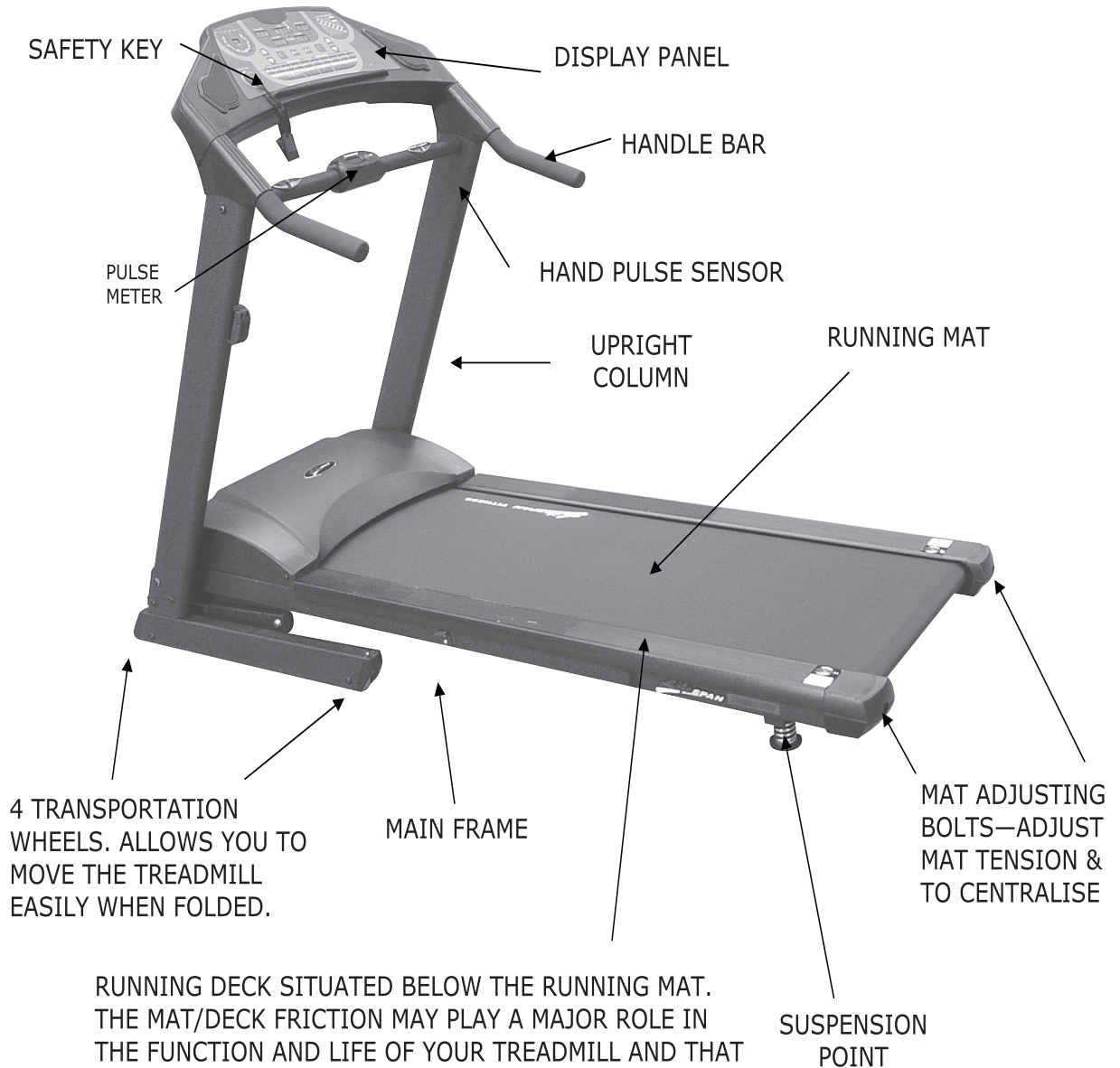

RUNNING DECK SITUATED BELOW THE RUNNING MAT. THE MAT/DECK FRICTION MAY PLAY A MAJOR ROLE IN THE FUNCTION AND LIFE OF YOUR TREADMILL AND THAT IS WHY WE RECOMMEND YOU CONSTANTLY LUBRICATE THIS FRICTION POINT TO PROLONG THE USEFUL LIFE OF YOUR TREADMILL. FAILING TO DO THIS MAY VOID YOUR WARRANTY.

2 ASSEMBLY INSTRUCTIONS

WE RECOMMEND YOU HAVE SOMEONE TO ASSIST YOU IN LIFTING AND ASSEMBLING YOUR LIFESPAN TREADMILL. FOLLOW THESE INSTRUCTIONS CAREFULLY AND IT WILL MAKE IT EASIER TO ASSEMBLE YOUR LIFESPAN TREADMILL

Step 1

Remove all parts from the carton, and place the treadmill onto the floor.

Step 2

Before placing the right upright in its position, be sure to connect the cable as pictured right. This is a very delicate procedure and if not completed correctly will cause the treadmill not to run correctly and in some cases not run at all. Make sure the pins inside the each plug line up when connecting the two plugs (view right)



Step 3

Install the left and right uprights into the bottom connectors. You will need 1 bracket and (7x) 8mm bolts. The bolts and bracket are pictured (right) exactly how they are to be attached to the upright (view right).

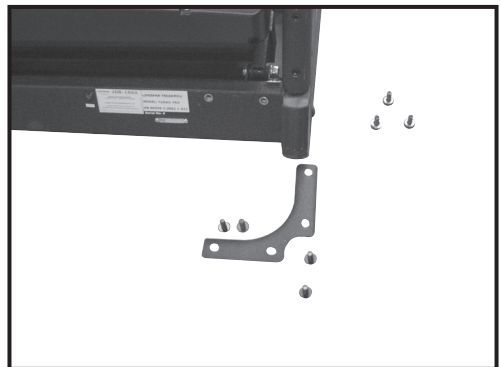

Step 4

Screw in the bolts as pictured right. DO NOT tighten the bolts fully till the display panel and sensor meter tube are connected (view right)

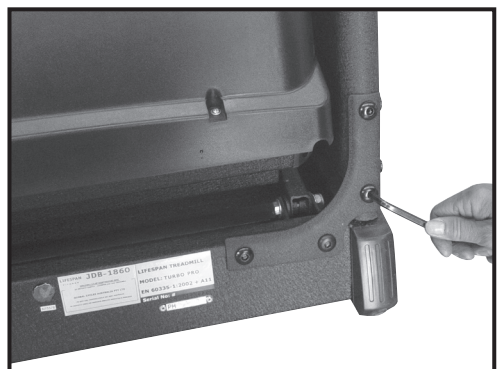

Step 5

Connect the cable to the display panel. Again this is a very delicate procedure so take care when undertaking this step. Then Slide the display panel down gently to connect it to the upright column posts. When completing this step, be mindful of the cable and make sure it doesn't get squashed (view right)



Step 6

Fix the display panel on both sides using (4x) 8mm bolts

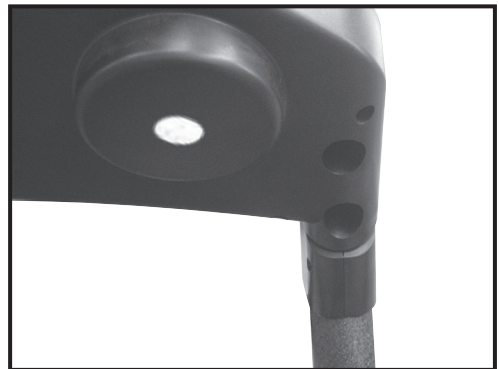

Step 7

Install the pulse meter tube to the two upright columns and fix it with (2x) 8mm bolts (view right). Please note that the heart rate meter is operated via independent AA batteries which need to be installed.



Step 8

Go over the entire treadmill and ensure all fixings are tightly secured and the treadmill is soundly constructed. Be sure to tighten the bolts mentioned in Step 4.

2.1 Folding Instructions

Do not attempt to move the unit unless it is in the folded and locked position. Be sure the power cord is secured to avoid possible damage.

- To fold the treadmill:
Lift the treadmill running deck until the supporting mechanism is over the safety latch.
- To Unfold the treadmill:
Apply slight forward pressure on the treadmill running deck. Pull the black safety latch outwards, and slowly lower the running deck to the floor (See below).

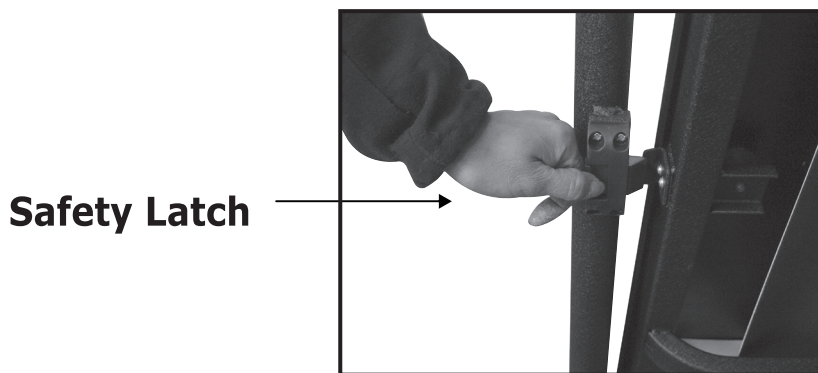

Transport

Carefully lift the treadmill at the rear roller area, grasping the two side end caps, and roll the treadmill away.

3 DISPLAY PANEL OPERATIONS



3.1 Safety Key

IMPORTANT: The treadmill will not operate if the safety key is not in place.

Before starting the treadmill, attach the magnetic key to the display panel, and then attach the clip on the other end to your clothing (above the waist). If the safety key is removed whilst you are operation the treadmill, the machine will turn itself off.

When the treadmill is not in use, you should remove the safety key.

Store the safety key in a safe place **OUT OF REACH OF CHILDREN.**

3.2 Getting Started

Power the treadmill on by plugging it into an appropriate wall outlet, then turn on the power switch located at the front of the treadmill below the motor shield. Ensure that the **safety key** is installed, as the treadmill will not power on without it.

When the power is turned on, all the lights on the display will light for a short time.

3.3 Quick-Start Operation:

1. Press and release the *START* to wake display up (if not already On). Note: Installing the safety key will also wake up the console.
2. Press and release the *START* to begin belt movement, at 1.0 Km/hr, then adjust to the desired speed using the up or down speed keys. You can also use to numbered keys 1-9 to select a desired speed. The speed range is from 1.0km/h to 22.0km/h.
3. To slow the treadmill down, press and hold the '*down*' speed key to desired speed or use the numbered keys 2-18.
4. To stop the treadmill press and release the *STOP button*. It will slow down gradually.

3.4 Incline Feature:

- Incline may be adjusted anytime after belt movement.
- The incline range is from 0 to 20%.
- Press the incline '*up*' and '*down*' keys to achieve desired level of effort or use the numbered keys 5-15%.
- The display will indicate incline percent as adjustments are made.
- Incline will remain in its position when display is turned off.

3.5 Pulse Grip Feature:

The Pulse (Heart Rate) console window will display your current heart rate in beats per minute during the workout. You must use both stainless steel sensors to display your pulse. Pulse value displays anytime the upper display is receiving a Grip Pulse signal. Please note that the heart rate meter is operated via independent AA batteries which need to be installed.

3.6 Calorie Display:

Displays the cumulative calories burned at any given time during your workout.

Note: This is only a rough guide used for comparison of different exercise Sessions, which cannot be used for medical purposes.

3.7 To Select a Preset Program:

This treadmill is equipped to run up to 82 programs. Any speed program can be selected with any incline program and vice versa. That gives you a total of 64 program options plus your standard speed and incline programs, user setting program (64 + 8 + 8+2). The

default speed on incline programs are set to run at 1km/h but can be changed to suit the speed you want.

To select one of the 8 Speed Programs: In STANDBY mode, press RESET key, the window will display 0. Press any speed short key, the speed window will display from S01 to S08. When it shows S08, press STOP key, the speed window shows normal, then quit the select mode. After selecting the correspondence presetting program, press START key to begin. The speed will change automatically according to preset parameter. Each program lasts for 30 minutes.

To select one of the 8 Incline Programs: In STANDBY mode, press RESET key, the windows will display 0. Then press the incline short key, the window will display from P01 to P08. When it displays P08, press STOP key, the incline window shows normal, then quit the select mode. After selecting the correspondence presetting program, press START key to begin. The incline will change automatically according to preset parameter. Each program lasts for 30 minutes.

User setting Program: In STANDBY mode, press MODE key for 5 seconds, the calorie window will display S09, the speed window will display 30:00 and begin to count down. Press MODE key to decrease 2 minute, while the speed window is flashing. Press the up or down speed key to change the speed. press the MODE key again. and the calorie window will display S10, the same setting with above. When you finished the setting, and in STANDBY mode, press the speed shortcut key, when calorie window display S09 or S10, press START key to begin.

3.8 User Program

When in P0 press Reset key to reset the machine, press speed key and set speed required, press time key and set time required or you can choose to press distance key and set distance required rather than speed. PLEASE NOTE: YOU CANNOT SET TIME AND DISTANCE WITHIN THE SAME EXERCISE. YOU WILL NOT GET THE DESIRED WORKOUT. YOU MUST SELECT EITHER TIME OR DISTANCE WITH THE SPEED FUNCTION.

Now press Start and treadmill will automatically speed up to preset values. NOTE speeds highest setting is 22 km/h and Time and Distance will count down to zero but will warn you with a buzz that it is going to stop. You can press *clear* to reset display to zero.

3.9 Entertainment

Insert the U disk or MP3 to the USB port(Use the standard U disk or MP3, which can download music from computer. Please use the original connecting line of the MP3). Press the MUSIC ON/OFF button until the "POWER" red light turns on. The U disk or MP3 will make a self-examine for 3 seconds. Press the  button, the "PLAY" green light will turn on, and will flash with the rhythm of the music. This feature can be turned off directly when the system is closed down. The Red light gose out.

The exchange among different modes, press the EQ button. There are 4 modes. NORMAL, POP, CLASSIC AND ROCK.

When you insert the MP3 to the USB port, the button of the MP3 will not effect, if you want to change the song, please use the button on the meter.

3.10 Preset Programs

Preset incline Programs

P1															
TIME (mins)	30	28	26	24	22	20	18	16	14	12	10	8	6	4	2
Incline (%)	0	6	8	10	12	14	15	15	14	12	10	8	6	4	2
P2															
TIME (mins)	30	28	26	24	22	20	18	16	14	12	10	8	6	4	2
Incline (%)	0	6	8	12	8	4	6	8	10	8	6	4	6	4	2
P3															
TIME (mins)	30	28	26	24	22	20	18	16	14	12	10	8	6	4	2
Incline (%)	0	6	3	6	9	12	15	12	9	6	3	6	9	6	3
P4															
TIME (mins)	30	28	26	24	22	20	18	16	14	12	10	8	6	4	2
Incline (%)	0	6	13	13	13	6	6	6	13	13	13	9	9	3	3
P5															
TIME (mins)	30	28	26	24	22	20	18	16	14	12	10	8	6	4	2
Incline (%)	0	14	3	3	12	12	3	3	14	14	3	3	12	3	3
P6															
TIME (mins)	30	28	26	24	22	20	18	16	14	12	10	8	6	4	2
Incline (%)	0	12	15	15	12	8	4	8	12	15	15	12	8	4	2

P7

TIME (mins)	30	28	26	24	22	20	18	16	14	12	10	8	6	4	2
Incline (%)	0	11	3	15	3	13	3	11	3	9	3	7	3	5	3

P8

TIME (mins)	30	28	26	24	22	20	18	16	14	12	10	8	6	4	2
Incline (%)	0	12	3	15	3	12	3	15	3	12	3	15	3	6	3

Preset speed Programs**S1**

TIME (mins)	30	28	26	24	22	20	18	16	14	12	10	8	6	4	2
Speed (Km/h)	2.0	4.0	6.0	10.0	6.0	10.0	6.0	10.0	6.0	10.0	6.0	10.0	6.0	4.0	2.0

S2

TIME (mins)	30	28	26	24	22	20	18	16	14	12	10	8	6	4	2
Speed (Km/h)	2.0	4.0	6.0	8.0	6.0	8.0	6.0	8.0	6.0	8.0	6.0	8.0	6.0	4.0	2.0

S3

TIME (mins)	30	28	26	24	22	20	18	16	14	12	10	8	6	4	2
Speed (Km/h)	4.0	8.0	4.0	8.0	4.0	8.0	4.0	8.0	4.0	8.0	4.0	8.0	4.0	8.0	4.0

S4

TIME (mins)	30	28	26	24	22	20	18	16	14	12	10	8	6	4	2
Speed (Km/h)	2.0	4.0	4.0	2.0	12.0	2.0	12.0	2.0	8.0	2.0	6.0	2.0	6.0	4.0	2.0

S5

TIME (mins)	30	28	26	24	22	20	18	16	14	12	10	8	6	4	2
Speed (Km/h)	3.0	8.0	12.0	11.0	11.0	12.0	12.0	9.0	9.0	6.0	6.0	4.0	4.0	2.0	2.0

S6

TIME (mins)	30	28	26	24	22	20	18	16	14	12	10	8	6	4	2
Speed (Km/h)	4.0	9.0	9.0	12.0	12.0	11.0	11.0	12.0	12.0	9.0	9.0	6.0	6.0	3.0	3.0

S7

TIME (mins)	30	28	26	24	22	20	18	16	14	12	10	8	6	4	2
Speed (Km/h)	3.0	6.0	8.0	8.0	12.0	12.0	12.0	11.0	11.0	11.0	10.0	10.0	10.0	5.0	5.0

S8

TIME (mins)	30	28	26	24	22	20	18	16	14	12	10	8	6	4	2
Speed (Km/h)	3.0	6.0	6.0	6.0	8.0	8.0	8.0	12.0	12.0	12.0	8.0	8.0	8.0	4.0	4.0

4 MAINTENANCE

Reasonable cleaning/lubricating should be made to extend the life time of this unit. Performance is maximized when the belt and mat are kept as clean as possible.

WARNING: THE MAT/DECK FRICTION MAY PLAY A MAJOR ROLE IN THE FUNCTION AND LIFE OF YOUR TREADMILL AND THAT IS WHY WE RECOMMEND YOU CONSTANTLY LUBRICATE THIS FRICTION POINT TO PROLONG THE USEFUL LIFE OF YOUR TREADMILL. FAILING TO DO THIS MAY VOID YOUR WARRANTY.

WARNING: UNPLUG POWER CORD BEFORE MAINTENANCE.

WARNING: STOP TREADMILL BEFORE FOLDING.

4.1 General Cleaning

- Use a soft, damp cloth to wipe the edge of the belt and the area between the belt edge and frame. A mild soap and water solution along with a nylon scrub brush will clean the top of the textured belt. This task should be done once a month. Allow to dry before using.
- On a monthly basis, vacuum underneath your treadmill to prevent dust build up. Once a year, you should remove the black motor shield and vacuum out dirt that may accumulate.

4.2 General Care

- Check parts for wear before use.
- Pay particular attention to the fixing knobs and make sure they are tight.
- Always replace the mat if worn and any other defective parts.
- If in doubt do not use the treadmill and contact our helpline.

TAKE CARE TO PROTECT CARPETS AND FLOOR in case of leakages. This product is a machine that contains moving parts which have been greased / lubricated and could leak.

4.3 Belt/Deck/Roller Lubrication:

The mat/deck friction may play a major role in the function and life of your treadmill and that is why we recommend you constantly lubricate this friction point to prolong the useful life of your treadmill.

Lubrication is provided with this unit. You should apply the enclosed lubrication after approximately the first 50 hours of operation. We recommend lubrication of the deck according to the following timetable:

Light use (less than 3 hours per week) every 6 months

Medium use (3-5 hours a week) every 3 months

Heavy use (more than 5 hours per week) every 6-8 weeks.

See below procedures for lubricating:

1. Use a soft, dry cloth to wipe the area between the belt and deck.
2. Spread lubricant onto the inside surface of belt and deck evenly (make sure the machine is turned off and power is disconnected).
3. Periodically lubricate the front and rear rollers to keep them at their peak performance.
If the treadmill belt/deck/roller is kept reasonably clean it is possible to expect over 1200 hours before additional re-lubing is necessary.

4.4 How to check the running mat for proper lubrication:

1. Disconnect the main power supply.
2. Fold the treadmill up into the storage position.
3. Feel the back surface of the running mat.

If the surface is slick when touched, then no further lubrication is needed.

If the surface is dry to the touch, apply a suitable silicone lubricant.

We recommend you use a silicone based spray to lubricate your Lifespan Treadmill. This Can be purchased from your local sports Retailer or a local hardware store.

4.5 Belt Adjustment

Belt Tension Adjustment-It is very important for joggers and runners in order to provide a smooth, steady running surface. Adjustment must be made from the right and left rear roller in order to adjust tension with the Hexagonal Wrench provided in the parts package. The adjustment bolt is located at the end of the rails as noted in diagram below:

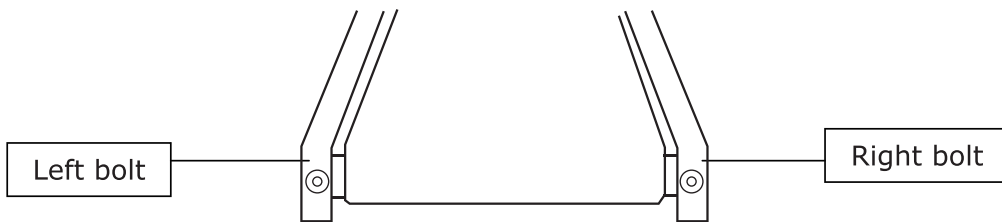

Note: Adjustment is thru the small hold on the end caps.

Tighten the rear roller only enough to prevent slippage at the front roller. Turn both the right and left bolt clockwise reasonably and inspect for proper tension. When an adjustment is made to the belt tension, you must also make a tracking adjustment to compensate for the change in belt tension.

DO NOT OVERTIGHTEN - Over tightening will cause belt damage and premature bearing failure.

4.6 Belt Tracking Adjustment:

This treadmill is designed to keep the belt reasonably centred while in use. It is normal for some belts to drift near one side while the belt is running with no one on it. After a few minutes of use, the belt should have a tendency to centre itself. If during use, the belt continues to move toward one side, adjustments are necessary. The procedures are as below:

- ▲ First set speed at lowest position.
- ▲ Second check the belt shifts to which side.

If the belt shifts to right, tighten the right bolt and loosen the left bolt by using 6mm Hexagonal Wrench, until the belt is centered itself; If belt shifts to left, tighten the left bolt and loosen the right bolt by using 6mm Hexagonal Wrench, until the belt is

centered. When adjusting the belt using the 6 mm Hexagonal Wrenches, it is important to adjust the belt in half turn increments. Over adjusting the belt can cause damage to the mat.

5 TROUBLE SHOOTING

This treadmill is designed in a way that in the event of an electrical fault, the machine will turn off automatically to prevent any injuries to the user and to prevent damage to the machine (i.e. motor).

When the treadmill behaves erratically, simply reset the treadmill by turning the power switch off, waiting for 1 minute then turning the power button back on.

If, after you have reset the treadmill, it is still not running correctly, please run the self-checking analyse (please refer to **3.3 Self-Checking**) to distinguish what type of error problem the machine is encountering.

5.1 Alarm signals

Before attempting any work on the treadmill, ensure that the power is off and the plug is removed from the power point.

Do not use extension leads as it may lead to power decrease and failure.

No feedback from controller or speed sensor

1. Check the condition of cables and ensure that all plugs are connected between the motor controller and display.
2. Check that the speed sensor and magnet are in correct alignment and that there are no obstructions on the magnet. (The magnet can be found on the front roller near the motor belt).
3. If the running belt moves then displays the E1 error replace the speed sensor.
4. If the running belt does not move replace the controller.

Controller problem

1. Replace the controller

Over speed protection. (Sudden increase of running belt speed).

1. Check the speed sensor and magnet are in correct alignment and that there are no obstructions on the magnet.
2. Check wire connections on the controller.
3. Replace the speed sensor.
4. Replace the controller.

Incline fault

1. Replace incline motor.
2. If problem remains replace controller.

When alarm signals are displayed, single press 'CLEAR' to reset the displays and try again.

No Power

1. Check fuses (They are located on the controller under the motor cover next to the on/off switch.
2. Check power outlet (Plug something else into the power outlet to ensure that the power outlet is working correctly).
3. Check Power Cable (You may need to take it to an electrician).

6 EXERCISE GUIDE

PLEASE NOTE: Before beginning any exercise program, consult your physician. This is important especially if you are over the age of 35 or individuals with pre-existing health problems.

The pulse sensors are not medical devices. Various factors, including the user's movement, may affect the accuracy of heart rate readings. The pulse sensors are intended only as an exercise aid in determining heart rate trends in general.

Exercising is a great way to control your weight, improve your fitness and reduce the effects of aging and stress. The key to success is to make exercise a regular and enjoyable part of your everyday life.

The condition of your heart and lungs and how efficient they are in delivering oxygen via your blood to your muscles is an important factor to your fitness. Your muscles use this oxygen to provide enough energy for daily activity. This is called aerobic activity. When you are fit, your heart will not have to work so hard. It will pump a lot fewer times per minute, reducing the wear and tear of your heart.

So as you can see, the fitter you are, the healthier and greater you will feel.

6.1 Workout Guidelines

TARGET ZONE

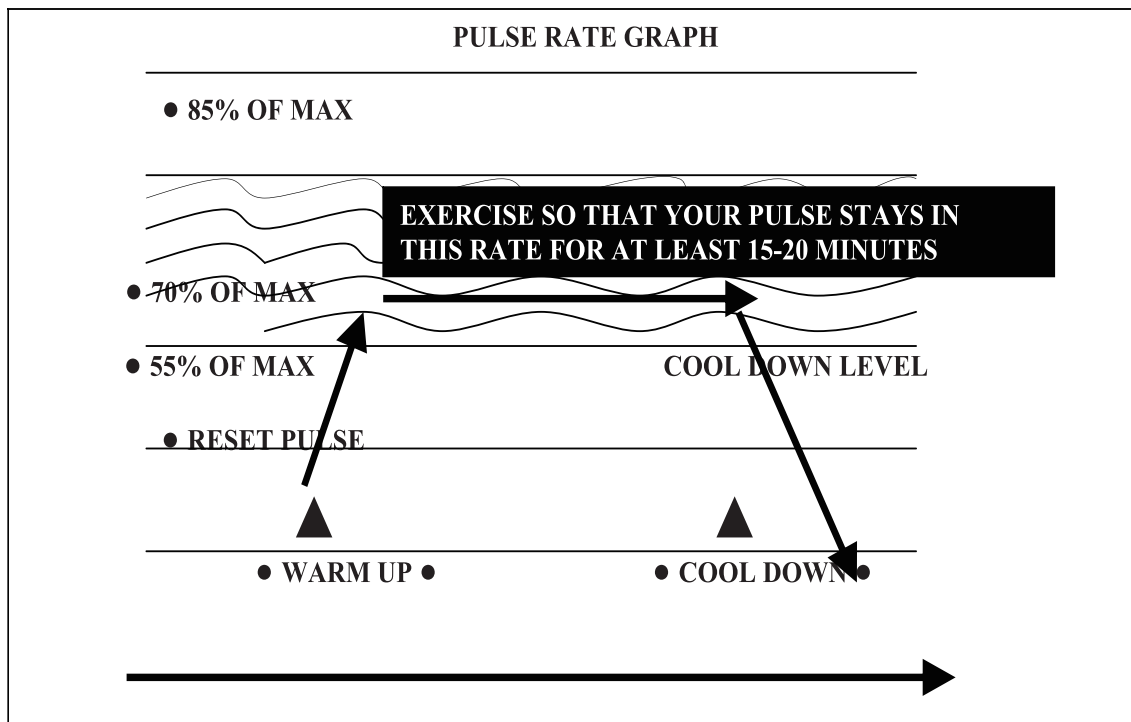

THIS IS HOW YOUR PULSE SHOULD BEHAVE DURING GENERAL FITNESS EXERCISE. REMEMBER TO WARM UP AND COOL DOWN FOR A FEW MINUTES.

Warm-up

Start each workout with 5 to 10 minutes of stretching and some light exercises. A proper warm-up increases your body temperature, heart rate and circulation in preparation for exercise. Ease into your exercise.

Training zone Exercise

After warming up, increase the intensity to your desired exercise program. Be sure to maintain your intensity for maximum performance. Breathe regularly and deeply as you exercise-never hold your breathe.

Cool Down

Finish each workout with a light jog or walk for at least 1 minute. Then complete 5 to 10 minutes of stretching to cool down. This will increase the flexibility of your muscles and will help prevent post-exercise problems.

7 WARRANTY REGISTRATION

Please visit the following link to complete the product warranty form online. Please visit http://www.lifespanfitness.com.au/modules/liaise/index.php?form_id=1

PLEASE NOTE: YOUR WARRANTY IS ONLY VALID IF YOU CAN PROVE YOU ARE THE ORIGINAL PURCHASER ON THIS ITEM (i.e. a copy of the receipt, invoice, delivery date or internet confirmation).