

# KINGSMITH WalkingPad Treadmill User Manual

Please read this manual carefully before using and then keep it in a safe place.



Manufacturer: Beijing Kingsmith Technology Co., Ltd.  
Address: Floor 4, Building 25, Area 18, ABP Park, Fengtai, Beijing, China.  
MADE IN CHINA

Model No. : *TRG1F*

***WalkingPad***

**KING SMITH**



## IMPORTANT SAFETY INSTRUCTIONS

---

The appliance is intended for residential use.



**DANGER** – To reduce the risk of electric shock:

Always unplug this appliance from the electrical outlet immediately after using and before cleaning.



**WARNING** – To reduce the risk of burns, fire, electric shock, or injury to persons:

- 1) An appliance should never be left unattended when plugged in. Unplug from outlet when not in use, and before putting on or taking off parts.
- 2) Close supervision is necessary when this appliance is used by, or near children, invalids, or disabled persons.
- 3) Use this appliance only for its intended use as described in this manual. Do not use attachments not recommended by the manufacturer.
- 4) Never operate this appliance if it has a damaged cord or plug, if it is not working properly, if it has been dropped or damaged, or dropped into water. Return the appliance to a service center for examination and repair.
- 5) Do not carry this appliance by the supply cord or use the cord as a handle.
- 6) Keep the cord away from heated surfaces.
- 7) Never drop or insert any object into any opening.
- 8) Do not use outdoors.
- 9) Do not operate where aerosol (spray) products are being used or where oxygen is being administered.
- 10) To disconnect, turn all controls to the off position, then remove the plug from the outlet.

## IMPORTANT SAFETY INSTRUCTIONS

---



1. This appliance can be used by children aged from 8 years and above and persons with reduced physical, sensory or mental capabilities or lack of experience and knowledge if they have been given supervision or instruction concerning use of the appliance in a safe way and understand the hazards involved. Children shall not play with the appliance. Cleaning and user maintenance shall not be made by children without supervision.
2. Correct Disposal of this product. This marking indicates that this product should not be disposed with other household wastes throughout the EU. To prevent possible harm to the environment or human health from uncontrolled waste disposal, recycle it responsibly to promote the sustainable reuse of material resources. To return your used device, please use the return and collection systems or contact the retailer where the product was purchased. They can take this product for environmental safe recycling.

This appliance is not intended for use by persons (including children) with reduced physical, sensory or mental capabilities, or lack of experience and knowledge, unless they have been given supervision or instruction concerning use of the appliance by a person responsible for their safety.

Children should be supervised to ensure that they do not play with the appliance.

**WARNING:** keep young children away from this machine at all times. Contact with the moving surface may result in severe friction burns.

## Contents

---

1. Product and Accessories	02
2. Function Diagram	03
3. Guide for Initial Use	07
4. Operational Instructions	09
5. Trademark and Legal Notice	12
6. Safety Precautions	13
7. Care and Maintenance	16
8. Replacement and Disposal	17

## Welcome

Thank you for choosing KingSmith WalkingPad Treadmill (hereinafter referred to as “the Treadmill” or “this product”). Its exquisite, simple and innovative design helps you enjoy a quality life of healthy exercise at home. This product is only designed for home use, not for business, leasing or public group purposes.

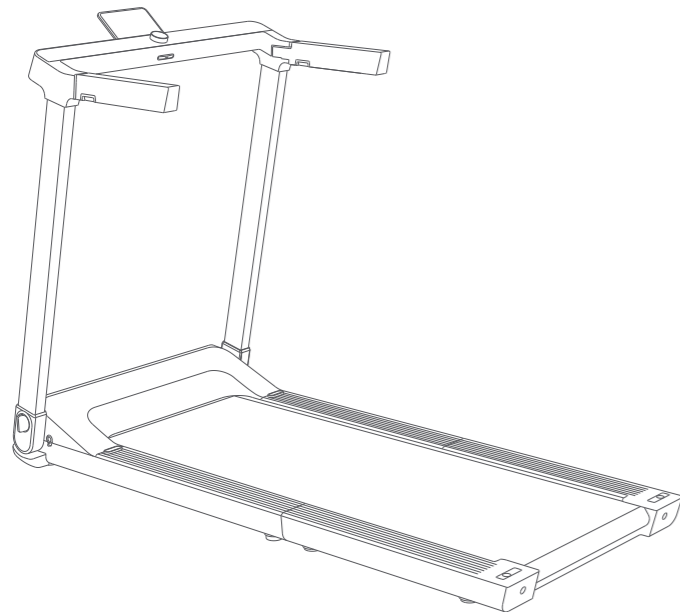

Performance Index	Parameter
Applicable age	14-60 years old
Speed range	1-12 km/h
Running area	440×1200 mm
Maximum load	110 kg
Frequency	50/60 Hz
Voltage	220-240 V~
Power Input	918 W
Net weight	38 kg
Unfolding dimension	1437×744×1004 mm
Folding dimension	983×744×194 mm
Product class	HC

## 1. Product and Accessories

Please check carefully whether the items in the packing box are complete and intact, and contact 400-188-7795 if you find any items missing or damaged.

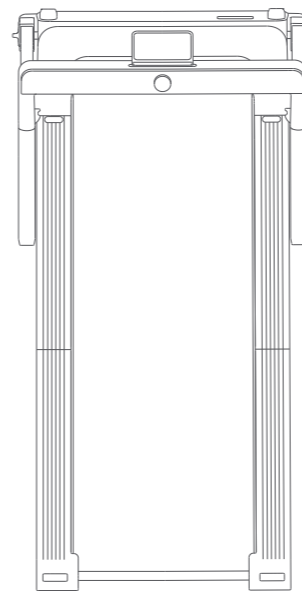

Treadmill

### Accessories



Power cord



Mobile phone holder



Security lock



Wrench



Silicone oil



User Manual

## 2. Function Diagram

---

### 1. Unfolding state

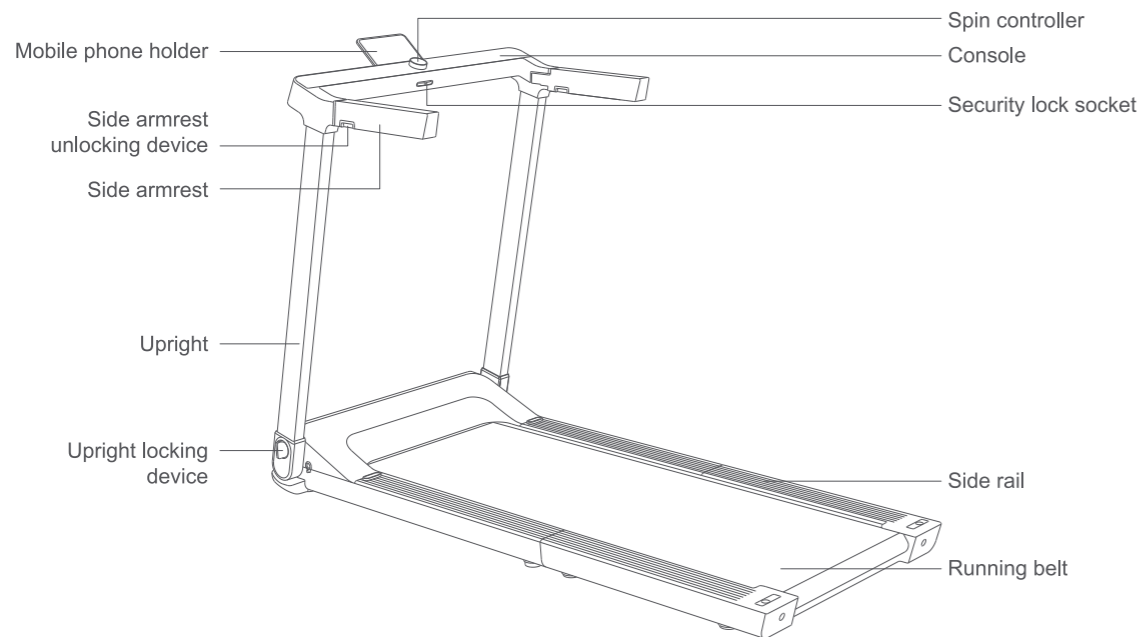

### 2. Folding state

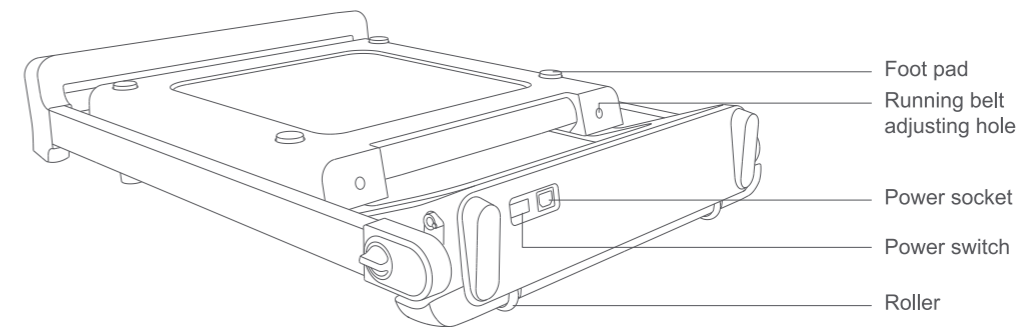

### 3. Console functions

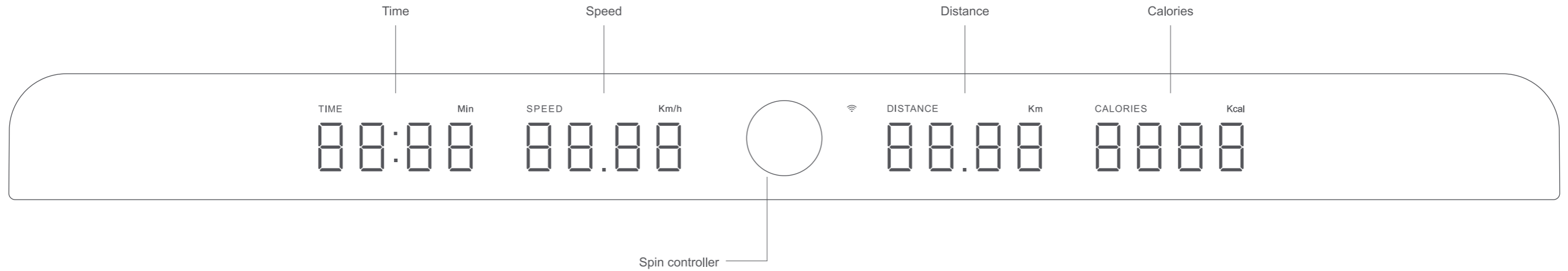

### 3. Guide for Initial Use

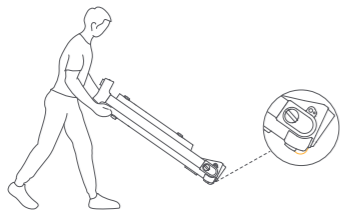

1. Before pushing or pulling this product, please make sure that the Treadmill is locked, and place it on a flat ground.

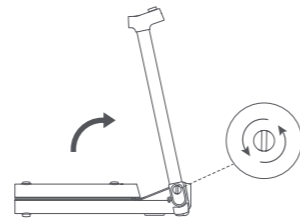

2. Rotate the unlocking device of the armrest on both sides counterclockwise three to five turns to unlock the armrest, lift it up to the greatest extent, rotate clockwise the locking spin and tighten it.

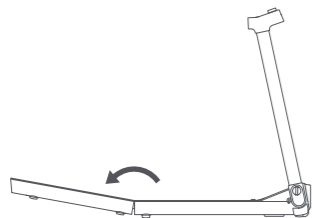

3. Unfold the Treadmill, adjust the running belt to the center position, slowly unfold and push the Treadmill down, or rotate the bottom foot pad to completely flatten it.

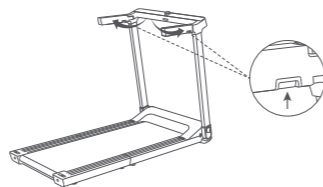

4. Press the unlocking device for the side armrest and spread it out.

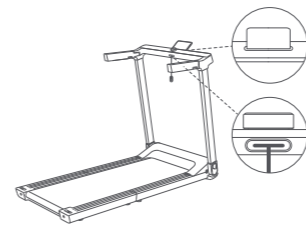

5. Take the mobile phone holder and security lock out of the accessory box and insert them into the corresponding socket.



7. Scan the QR code above or search for "KS Fit" in the APP store to complete installation and sign-up.

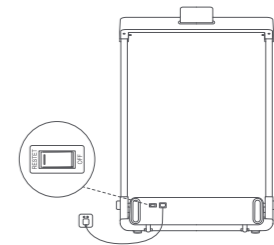

6. Turn on the Treadmill switch after connecting the power cord.

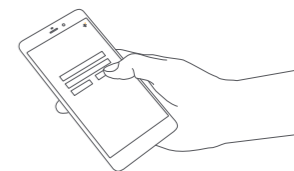

8. Before using the Treadmill, open the APP and follow the prompts to pair the Treadmill through the APP.

## 4. Operational Instructions

### 1. Start running



1. After this product is powered on, the console will be lit up, and all parameters will be displayed as "0" by default.

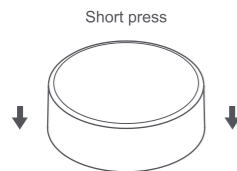

3. Short press the spin controller for 3 seconds in the default mode to start the Treadmill slowly.



2. If the security lock is not inserted, the console will display "SAFE", meaning the "safe" mode is activated. In this case, the Treadmill cannot start normally, so please insert the security lock.

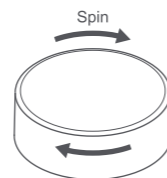

4. Rotate the spin controller clockwise to accelerate during movement. Rotate the spin controller counterclockwise to decelerate during movement.

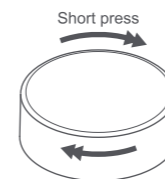

5. Fast speed regulation: Rotate the spin controller quickly to switch the speed levels, which will be switched among levels 1, 2, 4, 6, and 7.5.

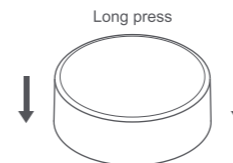

7. In the pause mode, after the spin controller is long pressed for 2 seconds or no-operation state lasts for 10 minutes, all parameters on the console will return to "0" by default and the Treadmill will enter the standby mode.



6. After the spin controller is short pressed during movement, or after the no-load operation lasts for 1 minute, the Treadmill will slowly stop and enter the pause mode. Then, short press the spin controller again to restart the Treadmill, which will return to the original speed level before the pause.

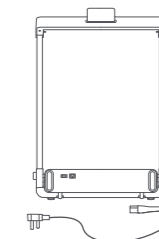

8. After finishing your exercise, please turn off the power switch and put away the power cord.



## 2. APP connection indicator light

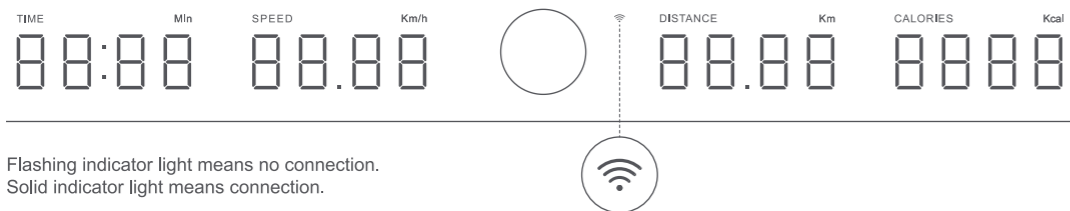

Flashing indicator light means no connection.  
Solid indicator light means connection.

## 3. Child safety lock

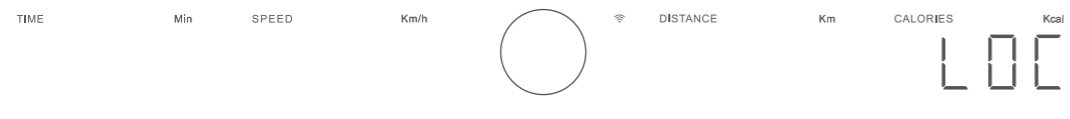

Activate or deactivate child safety lock on the APP. The Treadmill won't start when the child safety lock is on and the console will show "LOC".

## 5. Trademark and Legal Notice

### 4. Standby and wake-up mode

In the default mode (all parameters are displayed as "0"), if you long press the spin controller for 3 seconds or keep the Treadmill idle for 10 minutes, the Treadmill will be switched to the standby mode, and the console lights will go off. In the standby mode, short press the spin controller to wake up the Treadmill.

### 5. Fault codes

E01: Software overcurrent	E07: Motor lock-rotor protection
E02: Hardware overcurrent	E09: Motor failure to start
E03: IPM Module Overheating	E12: Motor overcurrent protection
E04: Undervoltage protection	E13: Overloading protection
E05: Overvoltage protection	E14: Hall signal loss
E06: Motor phase loss protection	E15: Communication error

### 6. Exercise guidelines

Warm-up: Start with 5 to 10 minutes of stretching before light exercise.

Exercise: Exercise for 20 to 30 minutes each time in your training zone. (During the first few weeks of your exercise program, do not exercise for longer than 20 minutes.) Breathe regularly as you exercise.

Cooling down: Finish with 5 to 10 minutes of stretching. Stretching increases the flexibility of your muscles and helps to prevent post-exercise problems.

Note: The no-load noise is 65dB when the equipment is running, and the noise value under actual load state is greater than the no-load noise.

The patents involved in Kingsmith WalkingPad Treadmill series products are made by Beijing Kingsmith Technology Co., Ltd. and owned by the Company. No organization or individual may copy, distribute all or any part of this manual without Kingsmith's written permission, and may not use these patents without authorization.

When printing this manual, we have put various functional descriptions and instructions in it as far as possible.

However, due to the continuous improvement of product functions and design changes, there may still be discrepancies with the products you purchased. Due to product update, this manual may deviate from the actual product in terms of color, appearance, etc. Please refer to the actual product.

## 6. Safety Precautions

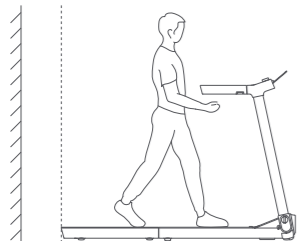

- ⚠ There should be a space of more than 2,000mm behind the Treadmill. In case of any emergency, you can hold the armrest with both hands to support your body before jumping off the Treadmill.

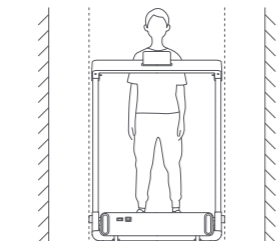

- ⚠ The distance between the Treadmill and other objects on the two sides should be at least 500mm.

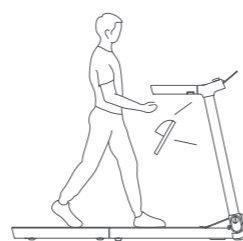

- ⚠ Please wear sports shoes and clothes and exercise moderately according to your own conditions when using the Treadmill. If you feel uncomfortable during running, please stop immediately and consult your doctor to avoid possible risk of injury.

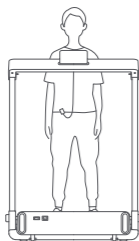

- ⚠ Before using this product, please clip the other end of the security lock to your clothes. In case of any emergency, pull off the security lock to stop the Treadmill immediately. Unplug and put away the security lock after using the Treadmill or when it is not in use to prevent it from getting started by accident.

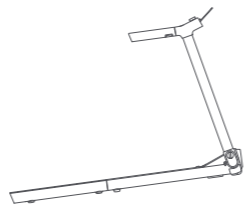

- ⊗ Do not operate the treadmill in damp or wet locations. Do not use it on irregular ground.

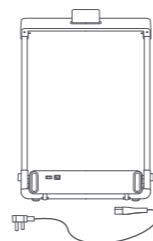

- ⚠ Please unplug the power cord when not in use.



- ⊗ Do not step on the head of the treadmill.

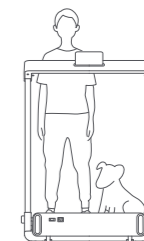

- ⊗ Do not bring pets when using the treadmill.

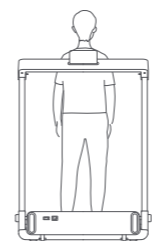

- ⊗ Do not use the treadmill backwards or sideways.



- ⚠ Elderly people, children, and pregnant women should use caution when using the treadmill.

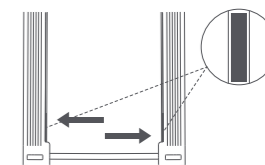

- ⚠ When the running belt deviates to the left or right and covers the limit mark, please stop using the equipment and adjust the running belt to the center position.

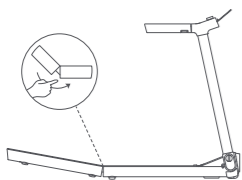

⚠ Watch your hands.

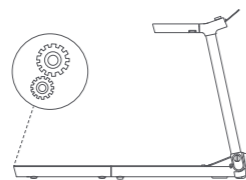

⚠ Take care of your belongings.



⊗ Do not fold before power off.



⚠ Flat storage treadmill . Please keep it away from children.

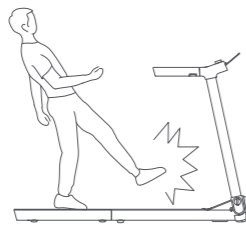

⊗ Do not get on and off when the treadmill operating.

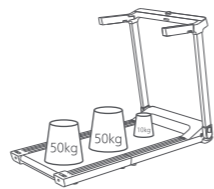

⚠ Weight capacity ≤ 110kg

## 7. Care and Maintenance

### 1. Treadmill cleaning



- Turn off and unplug the Treadmill.
- Apply an appropriate amount of soft detergent to a piece of 100% cotton cloth. Do not spray the detergent directly on the running belt or use any acid or corrosive detergent.
- Do not wipe under the running belt.
- Clean the dust and stains that might appear on the ground behind the product tail after use for a period of time.

### 2. Running belt slippage and adjustment

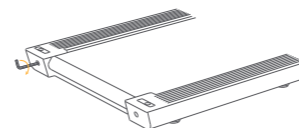

- Running belt moves to left: Rotate the left adjusting screw for a 1/4 circle clockwise.
- Running belt moves to right: Rotate the right adjusting screw for a 1/4 circle clockwise.
- Running belt slippage: Rotate the left and right adjusting screws for a 1/2 circle clockwise respectively at the same time.
- After each adjustment, the Treadmill needs to run for 1 to 2 minutes at a speed of 3 to 4km/h to verify the adjustment. If necessary, please adjust again.

### 3. Running belt lubrication

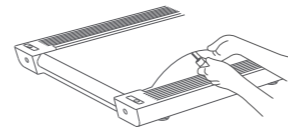

- Turn off and unplug the Treadmill.
- Uplift the edge of the running belt, and apply silicone oil to its inner surface. It is easier to operate when the Treadmill is not fully unfolded.
- Start the Treadmill, let it run at a speed of 3km/h for 10 to 20 seconds before use.
- Apply 5 to 10ml of silicone oil for lubrication each time, to avoid slipping and any negative impacts caused by the excessive use of silicone oil.
- Lubricate the running belt every three months.

## 8. Replacement and Disposal

---



The battery contained in this appliance must be removed for disposal.

When replacing the battery, use only original battery, available from our online parts shop.

The battery compartment is located on the back of the appliance. Open the compartment by removing the screw in the cover using a suitable screwdriver, and then press the lower end of the locking catch on the connectors. In that way, both sides of the connection can be separated by pulling them apart.

When inserting a new battery, push together the two connectors and ensure that the catch locks over the stop.

Never dispose of old battery in domestic garbage, but only through the proper public collection points. This also applies to the battery of defective appliances.



Devices marked with this symbol must be disposed of separately from your household waste, as they contain valuable materials that can be recycled. Proper disposal protects the environment and human health. Your local authority or retailer can provide information on the matter.